

HAEMATOKRIT 200



Ⓧ DE	Bedienungsanleitung	9
Ⓧ EN	Operating Manual	39
Ⓧ FR	Mode d'emploi	69
Ⓧ IT	Istruzioni per l'uso	100

Andreas Hettich GmbH & Co. KG
Föhrenstraße 12, D-78532 Tuttlingen / Germany
Phone +49 (0)7461 / 705-0
Fax +49 (0)7461 / 705-1125
info@hettichlab.com, service@hettichlab.com
www.hettichlab.com



© 2014 by Andreas Hettich GmbH & Co. KG

All rights reserved. No part of this publication may be reproduced without the prior written permission of the copyright owner.

Änderungen vorbehalten! , Modifications reserved! , Sous réserve de modifications ! , Con riserva di modifiche!

AB1801DEENFRIT / Rev. 06

EG-Konformitätserklärung
EC Declaration of conformity
Déclaration de conformité CE
Dichiarazione di conformità CE

des Herstellers / of the manufacturer / du fabricant / del costruttore
Andreas Hettich GmbH & Co. KG • Föhrenstraße 12 • D-78532 Tuttlingen • Germany

Hiermit erklären wir in alleiniger Verantwortung, dass das bezeichnete Gerät, inklusive dem mit dem Gerät konformitätsbewertetem Zubehör laut Zubehörliste der technischen Dokumentation dieses Geräts, der Richtlinie über In-vitro-Diagnostika 98/79/EG entspricht.

We hereby declare under our sole responsibility that the designated device and its accessories, which are listed in the technical documentation for this device and whose conformity has been assessed together with the device, conform to the Directive 98/79/EC on in vitro diagnostic medical devices.

Par la présente, nous déclarons sous notre seule responsabilité que l'appareil désigné, incluant ses accessoires attestés conformes d'après la liste des accessoires de la documentation technique du dit-appareil, répond à la directive 98/79/CE sur le diagnostic In-vitro.

Si dichiara nella nostra sola responsabilità, che l'apparecchiatura indicata, comprensiva dei conformi accessori come da elenco della documentazione tecnica di questa apparecchiatura, risponde alle direttive per Diagnostica In-Vitro 98/79/CE.

Geräteart / Type of device / Type d'appareil / Tipo di apparecchio:

Gerät zur zentrifugalen Trennung von Probenmaterial menschlichen Ursprungs zur Vorbereitung in-vitro diagnostischer Analysen.

Device for centrifugal separation of sample material of human origin for preparation of in-vitro diagnostic analyses.

Appareil de séparation par force centrifuge de prélèvements humains pour la préparation In-vitro d'analyses de diagnostic.

Apparecchiatura per la separazione centrifugale di materiale di campione di origine umana, per la preparazione di analisi diagnostiche in vitro.

Typenbezeichnung / Type designation / Désignation du type / Denominazione del tipo:

HAEMATOKRIT 200

Das Konformitätsbewertungsverfahren wurde nach Anhang III der Richtlinie 98/79/EG durchgeführt.

The conformity evaluation process was performed in accordance with appendix III of Directive 98/79/EC.

La procédure d'évaluation de la conformité a été réalisée conformément à l'annexe III de la directive 98/79/CE.

La procedura di valutazione di conformità è stata eseguita conformemente all'appendice III delle direttive 98/79/CE.

Folgende weitere europäische Richtlinien und Verordnungen wurden angewandt:

- Maschinenrichtlinie 2006/42/EG
- EMV-Richtlinie 2014/30/EU
- Niederspannungsrichtlinie 2014/35/EU
- RoHS II Richtlinie 2011/65/EU (ohne Beteiligung einer benannten Stelle)
- Verordnung (EG) Nr. 1907/2006 (REACH) (ohne Beteiligung einer benannten Stelle)

Angewandte Normen:

Gemäß Liste der angewandten Normen, die Teil der Produktakte ist.

The following additional European directives and ordinances have been applied:

- Machinery Directive 2006/42/EU
- EMC directive 2014/30/EU
- Low voltage directive 2014/35/EU
- RoHS II Directive 2011/65/EU (without involvement of a notified body)
- Ordinance (EC) No. 1907/2006 (REACH) (without involvement of a notified body)

Applied standards:

According to the list of applied standards, which is part of the product file.

Les autres directives et normes européennes suivantes ont été appliquées:

- Directive 2006/42/UE relative aux machines
- Directive CEM 2014/30/UE
- Directive basse tension 2014/35/UE
- Directive RoHS II 2011/65/UE (sans participation d'un organisme désigné)
- Directive (CE) no. 1907/2006 (REACH) (sans participation d'un organisme désigné)

Normes appliquées:

Conformément à la liste des normes appliquées relatives aux cycles du produit.

Sono state applicate le seguenti direttive e regolamenti europei:

- Direttive per macchine 2006/42/EU
- Direttive per compatibilità elettromagnetica 2014/30/EU
- Direttive per basse tensioni 2014/35/EU
- RoHS II direttive 2011/65/EU (senza concorso di un citato collaboratore)
- Regolamento (CE) n. 1907/2006 (REACH) (senza concorso di un citato collaboratore)

Norme applicate:

Conformemente alla lista delle norme applicate, che sono parte degli atti del prodotto.

Tuttlingen, 2016-07-20



Klaus-Günter Eberle
Geschäftsführer, Manager,
Directeur, Gerente



Für dieses Gerät gültige Normen und Vorschriften

Das Gerät ist ein Produkt mit einem sehr hohen technischen Niveau. Es unterliegt umfangreichen Prüf- und Zertifizierungsverfahren gemäß folgenden Normen und Vorschriften in deren jeweils gültigen Fassung:

Elektrische und mechanische Sicherheit für Konstruktion und Endprüfung:

Normbaureihe: IEC 61010 (entspricht der Normenreihe DIN EN 61010)

- IEC 61010-1 "Sicherheitsbestimmungen für elektrische Mess-, Steuer-, Regel- und Laborgeräte - Teil 1: Allgemeine Anforderungen" (Verschmutzungsgrad 2, Überspannungskategorie II)
- IEC 61010-2-010 "Sicherheitsbestimmungen für elektrische Mess-, Steuer-, Regel- und Laborgeräte – Teil 2-010: Besondere Anforderungen an Laborgeräte für das Erhitzen von Stoffen" (nur für Zentrifugen mit Heizung gültig)
- IEC 61010-2-020 "Sicherheitsbestimmungen für elektrische Mess-, Steuer-, Regel- und Laborgeräte - Teil 2-020: Besondere Anforderungen an Laborzentrifugen"
- IEC 61010-2-101 "Sicherheitsbestimmungen für elektrische Mess-, Steuer-, Regel- und Laborgeräte - Teil 2-101: Besondere Anforderungen an In-vitro-Diagnostik (IVD) Medizingeräte"

Elektromagnetische Verträglichkeit:

- EN 61326-1 "Elektrische Mess-, Steuer-, Regel- und Laborgeräte - EMV-Anforderungen - Teil 1: Allgemeine Anforderungen"

Risikomanagement:

- DIN EN ISO 14971 "Anwendung des Risikomanagements auf Medizinprodukte"

Beschränkung gefährlicher Stoffe (RoHS II):

- EN 50581 „Technische Dokumentation zur Beurteilung von Elektro- und Elektronikgeräten hinsichtlich der Beschränkung gefährlicher Stoffe“

Für Konformitätsbewertungsverfahren geltende Europäische Richtlinien:

- Richtlinie 98/79/EC über In-vitro-Diagnosegeräte
EG-Konformitätsbewertungsverfahren gemäß Anhang III "EG-Konformitätserklärung" – Eigenerklärung des Herstellers
- Richtlinie 2011/65/EU zur Beschränkung der Verwendung bestimmter gefährlicher Stoffe in Elektro- und Elektronikgeräten. Das EG-Konformitätsbewertungsverfahren erfolgt hierzu in alleiniger Verantwortung des Herstellers, ohne Beteiligung einer benannten Stelle.

Außerhalb Europas geltende Richtlinien für Medizinprodukte:

- **USA:** QSR, 21CFR 820 "CFR Title 21 - Food and Drugs: TITLE 21- FOOD AND DRUGS, CHAPTER I - FOOD AND DRUG ADMINISTRATION DEPARTMENT OF HEALTH AND HUMAN SERVICES, SUBCHAPTER H - MEDICAL DEVICES, Part 820 QUALITY SYSTEM REGULATIONS"
- **Kanada:** CMDR, SOR/98-282 "Medical Devices Regulations"

Zertifiziertes Qualitätsmanagementsystem gemäß

- ISO 9001 "Qualitätsmanagementsysteme - Anforderungen"
- ISO13485 "Qualitätsmanagementsysteme für Medizinprodukte - Anforderungen für regulatorische Zwecke"

Umweltmanagementsystem gemäß

- ISO 14001 "Umweltmanagementsysteme - Spezifikation mit Anleitung zur Anwendung"

Standards and regulations which apply to this device

The device is a high-end technical product. It is subject to extensive testing and certification procedures according to the following standards and regulations in their respectively valid version:

Electrical and mechanical safety for design and final testing:

Standard series: IEC 61010 (conform to standards of DIN EN 61010)

- IEC 61010-1 "Safety requirements for electrical equipment for measurement, control, and laboratory use - Part 1: General requirements" (Pollution Degree 2, Excess-voltage category II)
- IEC 61010-2-010 "Safety requirements for electrical equipment for measurement, control and laboratory use - Part 2-010: Particular requirements for laboratory equipment for the heating of materials" (applied to heated centrifuges only)
- IEC 61010-2-020 "Safety requirements for electrical equipment for measurement, control, and laboratory use - Part 2-020: Particular requirements for laboratory centrifuges"
- IEC 61010-2-101 "Safety requirements for electrical equipment for measurement, control and laboratory use - Part 2-101: Particular requirements for in vitro diagnostic (IVD) medical equipment"

Electromagnetic Compatibility:

- EN 61326-1 "Electrical equipment for measurement, control and laboratory use - EMC requirements - Part 1: General requirements"

Risk management:

- DIN EN ISO 14971 "Application of risk management to medical devices"

Restriction of Hazardous Substances (RoHS II):

- EN 50581 "Technical documentation for assessing electric and electronic devices with regard to the restriction of hazardous substances"

European directives applied for conformity assessment procedures:

- In vitro diagnostic device directive 98/79/EG
EC conformity assessment procedure according to annex III "EC DECLARATION OF CONFORMITY" – self-declaration by the manufacturer
- Directive 2011/65/EU for the restriction of use of certain hazardous substances in electric and electronic devices. Carrying out the EC conformity assessment process is the sole responsibility of the manufacturer, without the involvement of a notified body.

Applied medical device regulations outside Europe:

- **USA:** QSR, 21CFR 820 "CFR Title 21 - Food and Drugs: TITLE 21- FOOD AND DRUGS, CHAPTER I - FOOD AND DRUG ADMINISTRATION DEPARTMENT OF HEALTH AND HUMAN SERVICES, SUBCHAPTER H - MEDICAL DEVICES, Part 820 QUALITY SYSTEM REGULATIONS"
- **Canada:** CMDR, SOR/98-282 "Medical Devices Regulations"

Certified quality management system according to

- ISO 9001 "Quality management systems – Requirements"
- ISO13485 "Medical devices - Quality management systems - Requirements for regulatory purposes"

Environmental management system according to

- ISO 14001 "Environmental management systems - Requirements with guidance for use"

Normes et règles en vigueur pour cet appareil

Cet appareil est un produit avec un très haut niveau technique. Il est soumis à des vastes procédures de vérification et de certification, d'après les normes et prescriptions suivantes, dans leur version actuelle :

Sécurité électrique et mécanique pour la construction et l'inspection finale :

Série de normes : IEC 61010 (correspond à la série de norme DIN EN 61010)

- IEC 61010-1 "Règles de sécurité pour appareils électriques de mesure, de régulation et de laboratoire - partie 1 : Prescriptions générales" (niveau de sécurité 2, catégorie de surtension II)
- IEC 61010-2-010 "Règles de sécurité pour appareils électriques de mesure, de régulation et de laboratoire – partie 2-010 : Prescriptions particulières pour appareils de laboratoire utilisés pour l'échauffement des matières" (seulement valable pour centrifugeuses avec chauffage)
- IEC 61010-2-020 "Règles de sécurité pour appareils électriques de mesure, de régulation et de laboratoire – partie 2-020 : Prescriptions particulières pour centrifugeuses de laboratoire"
- IEC 61010-2-101 "Règles de sécurité pour appareils électriques de mesure, de régulation et de laboratoire – partie 2-101 : Prescriptions particulières pour les appareils médicaux de diagnostic in vitro" (DIV)

Compatibilité électromagnétique :

- EN 61326-1 "Matériel électrique de mesure, de commande et de laboratoire – Exigences relatives à la CEM - partie 1 : Exigences générales"

Gestion des risques :

- DIN EN ISO 14971 "Application de la gestion des risques aux dispositifs médicaux"

Restrictions relatives aux substances dangereuses (RoHS II):

- Norme européenne 50581 „Documentation technique pour l'évaluation des produits électriques et électroniques par rapport à la restriction des substances dangereuses“

Directives européennes valables pour des procédures d'évaluation de la conformité :

- directive 98/79/EC relative aux dispositifs médicaux de diagnostic in vitro
procédure d'évaluation de la conformité CE d'après l'annexe III "Déclaration CE de conformité" –
déclaration spécifique du fabricant
- Directives 2011/65/UE concernant les restrictions relatives à l'utilisation de certaines substances dangereuses dans les appareils électriques et électroniques. La procédure d'évaluation de la conformité CE est sous la seule responsabilité du fabricant, sans participation d'un organisme désigné.

Directives pour dispositifs médicaux, valables en dehors de l'Europe :

- **USA** : QSR, 21CFR 820 "CFR Title 21 - Food and Drugs : TITLE 21- FOOD AND DRUGS, CHAPTER I - FOOD AND DRUG ADMINISTRATION DEPARTMENT OF HEALTH AND HUMAN SERVICES, SUBCHAPTER H - MEDICAL DEVICES, Part 820 QUALITY SYSTEM REGULATIONS"
- **Canada**: CMDR, SOR/98-282 "Medical Devices Regulations"

Système de management de la qualité certifié d'après

- ISO 9001 "Systèmes de management de la qualité - Prescriptions"
- ISO13485 "Dispositifs médicaux - Systèmes de management de la qualité - Exigences à des fins réglementaires"

Système de management environnemental d'après

- ISO 14001 "Systèmes de management environnemental - Spécification avec description pour application"

Norme e direttive valide per questo apparecchio

L'apparecchio è un dispositivo di elevatissimo livello tecnico. È sottoposto a numerosi procedimenti di collaudo e certificazione, in conformità alle seguenti norme e direttive nella corrispondente versione di validità:

Sicurezza elettrica e meccanica per la costruzione ed il collaudo finale:

Serie di norma: IEC 61010 (corrisponde alla serie di norma DIN EN 61010)

- IEC 61010-1 “Norme di sicurezza per apparecchiature elettriche di misurazione, di comando, di regolazione e di laboratorio - parte 1: Requisiti generali” (grado di imbrattamento 2, Categoria di sovratensione II)
- IEC 61010-2 -010 “Norme di sicurezza per apparecchiature elettriche di misurazione, di comando, di regolazione e di laboratorio - parte 2-010: Requisiti particolari per le apparecchiature di laboratorio per il riscaldamento di materiali” (valido solo per centrifughe con riscaldamento)
- IEC 61010-2 -020 “Norme di sicurezza per apparecchiature elettriche di misurazione, di comando, di regolazione e di laboratorio - parte 2-020: Requisiti particolari per centrifughe di laboratorio”
- IEC 61010-2 -101 “Norme di sicurezza per apparecchiature elettriche di misurazione, di comando, di regolazione e di laboratorio - parte 2-101: Requisiti particolari per la diagnostica In-vitro (IVD) apparecchiature medicali”

Compatibilità elettromagnetica:

- EN 61326-1 “Apparecchiature elettriche di misurazione, di comando, di regolazione e di laboratorio - requisiti di compatibilità elettromagnetica - parte 1: Requisiti generali”

Gestione dei rischi:

- DIN EN ISO 14971 “Applicazione della gestione dei rischi ai dispositivi medici”

Restrizione per prodotti pericolosi (RoHS II):

- EN 50581 „Documentazione tecnica per la stesura di un protocollo di valutazione delle apparecchiature elettriche ed elettroniche per quanto riguarda la restrizione per prodotti pericolosi“

Direttive europee che sono di validità per il procedimento di valutazione della conformità:

- Direttive 98/79/CE per apparecchiature di diagnosi In-vitro
Procedimento di valutazione di conformità CE conforme all'appendice III "Dichiarazione di conformità CE" – Dichiarazione propria del costruttore
- Direttive 2011/65/EU per la restrizione di impiego di particolari prodotti pericolosi nelle apparecchiature elettriche ed elettroniche. Il procedimento di valutazione della conformità CE avviene al riguardo nella sola responsabilità del costruttore, senza concorso di un citato collaboratore.

Direttive valide al di fuori dell'ambito europeo per i prodotti medicali:

- **USA:** QSR, 21CFR 820 “CFR Title 21 - Food and Drugs: TITLE 21- FOOD AND DRUGS, CHAPTER I - FOOD AND DRUG ADMINISTRATION DEPARTMENT OF HEALTH AND HUMAN SERVICES, SUBCHAPTER H - MEDICAL DEVICES, Part 820 QUALITY SYSTEM REGULATIONS”
- **Kanada:** CMDR, SOR/98-282 “Medical Devices Regulations”

Certificato sistema di gestione della qualità, conforme a

- ISO 9001 “Requisiti per sistemi di gestione qualità”
- ISO13485 “Sistemi di gestione qualità per prodotti medicali - Requisiti per impieghi di regolazione”

Sistema di gestione ambientale, conforme a

- ISO 14001 “Sistemi di gestione ambientale - Specificazione con istruzioni per l'applicazione”

Inhaltsverzeichnis

1	Anwendung dieser Bedienungsanleitung.....	11
2	Bedeutung der Symbole	11
3	Bestimmungsgemäße Verwendung.....	11
4	Restrisiken.....	11
5	Technische Daten.....	12
6	Sicherheitshinweise	13
7	Transport und Lagerung	14
7.1	Transport	14
7.2	Lagerung	14
8	Lieferumfang.....	14
9	Transportsicherung entfernen.....	15
10	Inbetriebnahme	15
11	Deckel öffnen und schließen	16
11.1	Deckel öffnen	16
11.2	Deckel schließen.....	16
12	Ein- und Ausbau des Rotors.....	17
13	Beladen des Rotors.....	17
14	Bedien- und Anzeigeelemente	18
14.1	Angezeigte Symbole	18
14.2	Tasten des Bedienfeldes.....	18
14.3	Einstellmöglichkeiten.....	19
15	Zentrifugations-Parameter eingeben	20
15.1	Direkte Eingabe der Zentrifugations-Parameter	20
15.1.1	Drehzahl (RPM)	20
15.1.2	Relative Zentrifugalbeschleunigung (RCF) und Zentrifugerradius (RAD).....	20
15.1.3	Laufzeit	20
15.2	Eingabe der Zentrifugations-Parameter mit der Taste "SELECT"	21
16	Zentrifugation	23
16.1	Zentrifugation mit Zeitvorwahl	23
16.2	Dauerlauf	24
16.3	Kurzzeitzentrifugation.....	24
17	Not-Stopp	25
18	Einstellungen und Abfragen	25
18.1	System-Informationen abfragen.....	26
18.2	Akustisches Signal	28
18.3	Optisches Signal nach Beendigung des Zentrifugationslaufes	29
18.4	Automatisches Entriegeln des Deckels nach dem Zentrifugationslauf.....	30
18.5	Hintergrundbeleuchtung der Anzeige.....	31
18.6	Die Betriebsstunden und die Anzahl der Zentrifugationsläufe abfragen.....	32
19	Relative Zentrifugalbeschleunigung (RCF).....	33
20	Zentrifugation von Stoffen oder Stoffgemischen mit einer höheren Dichte als 1,2 kg/dm ³	33
21	Hämatokritbestimmung	33
21.1	Ermitteln der Zentrifugationszeit	33

21.2	Ablezen des Hämatokritwertes	33
22	Notentriegelung.....	34
23	Pflege und Wartung	34
23.1	Zentrifuge (Gehäuse, Deckel und Schleuderraum).....	35
23.1.1	Oberflächenreinigung und -pflege.....	35
23.1.2	Oberflächendesinfektion	35
23.1.3	Entfernen radioaktiver Verunreinigungen.....	35
23.2	Reinigen und Desinfizieren des Hämatokritrotors	35
23.3	Vorgehen bei zerbrochenen Hämatokritkapillaren	36
23.3.1	Rotoren und Zubehör mit begrenzter Verwendungsdauer	36
24	Störungen.....	37
25	Netzeingangssicherungen wechseln	38
26	Rücksendung von Geräten.....	38
27	Entsorgung.....	38
28	Anhang / Appendix.....	130
28.1	Rotoren und Zubehör / Rotors and accessories.....	130

1 Anwendung dieser Bedienungsanleitung

- Vor Benutzung der Zentrifuge ist die Bedienungsanleitung zu lesen und zu beachten.
- Die Bedienungsanleitung ist Teil des Gerätes. Sie muss stets griffbereit aufbewahrt werden.
- Wird das Gerät an einem anderen Ort aufgestellt, muss die Bedienungsanleitung mitgegeben werden.

2 Bedeutung der Symbole



Symbol am Gerät:
Achtung, allgemeine Gefahrenstelle.



Symbol am Gerät:
Bedienungsanleitung beachten.
Dieses Symbol verweist darauf hin, dass der Anwender die bereitgestellte Bedienungsanleitung beachten muss.



Symbol in diesem Dokument:
Achtung, allgemeine Gefahrenstelle.
Dieses Symbol kennzeichnet sicherheitsrelevante Hinweise und deutet auf mögliche gefährliche Situationen hin.
Das Nichtbeachten dieser Hinweise kann zu Sach- und Personenschäden führen.



Symbol am Gerät und in diesem Dokument:
Warnung vor Biogefährdung.



Symbol in diesem Dokument:
Dieses Symbol deutet auf wichtige Sachverhalte hin.



Symbol am Gerät:
Das Symbol befindet sich am Gehäuse, in der Nähe des Scharniers.
Drehrichtung des Rotors.



Symbol am Gerät:
Das Symbol befindet sich vorne am Gehäuse, unterhalb der Bohrung.
Drehrichtung des Sechskant-Stiftschlüssels zur Notentriegelung des Deckels.



Symbol am Gerät und in diesem Dokument:
Symbol für die getrennte Sammlung von Elektro- und Elektronikgeräten, gemäß der Richtlinie 2002/96/EG (WEEE). Das Gerät gehört zur Gruppe 8 (Medizinische Geräte).
Verwendung in den Ländern der Europäischen Union sowie in Norwegen und der Schweiz.

3 Bestimmungsgemäße Verwendung

Bei dem vorliegenden Gerät handelt es sich um ein Medizinprodukt (Laborzentrifuge) im Sinne der IVD-Richtlinie 98/79/EG.

Die Zentrifuge dient zur Zentrifugation von Blutproben menschlichen Ursprungs in Hämatokrit-Kapillaren gemäß EN ISO 12772 oder in speziellen herstellereigenen Kapillaren zur quantitativen Buffy Coat Analyse.

Die Zentrifuge ist nur für diesen Verwendungszweck bestimmt.

Eine andere oder darüber hinausgehende Benutzung gilt als nicht bestimmungsgemäß. Für hieraus entstehende Schäden haftet die Firma Andreas Hettich GmbH & Co. KG nicht.

Zur bestimmungsgemäßen Verwendung gehört auch das Beachten aller Hinweise aus der Bedienungsanleitung und die Einhaltung der Inspektions- und Wartungsarbeiten.

Wird die Zentrifuge in ein anderes Gerät eingebaut oder in ein System integriert, so ist der Hersteller des Gesamtsystems für dessen Sicherheit verantwortlich.

4 Restrisiken

Das Gerät ist nach dem Stand der Technik und den anerkannten sicherheitstechnischen Regeln gebaut. Bei unsachgemäßer Verwendung und Behandlung können Gefahren für Leib und Leben des Benutzers oder Dritter bzw. Beeinträchtigungen an dem Gerät oder an anderen Sachwerten entstehen. Das Gerät ist nur für die bestimmungsgemäße Verwendung, und nur in sicherheitstechnisch einwandfreiem Zustand zu benutzen.

Störungen, die die Sicherheit beeinträchtigen können, sind umgehend zu beseitigen.

5 Technische Daten

Hersteller	Andreas Hettich GmbH & Co. KG D-78532 Tuttlingen	
Modell	HAEMATOKRIT 200	
Typ	1801	1801-01
Netzspannung ($\pm 10\%$)	200 - 240 V 1~	100 - 127 V 1~
Netzfrequenz	50 - 60 Hz-	50 - 60 Hz-
Anschlusswert	270 VA	270 VA
Stromaufnahme	1.3 A	2.6 A
Kapazität max.	24 x 2.2 ml	
zulässige Dichte	1.2 kg/dm ³	
Drehzahl (RPM)	13000	
Beschleunigung (RCF)	16060	
Kinetische Energie	950 Nm	
Prüfpflicht (BGR 500)	nein	
Umgebungsbedingungen (EN / IEC 61010-1)	<p>nur in Innenräumen bis zu 2000 m über Normal-Null 2°C bis 40°C maximale relative Luftfeuchte 80% für Temperaturen bis 31°C, linear abnehmend bis 50% relativer Luftfeuchte bei 40°C.</p>	
– Aufstellungsort		
– Höhe		
– Umgebungstemperatur		
– Luftfeuchtigkeit		
– Überspannungskategorie (IEC 60364-4-443)	II	
– Verschmutzungsgrad	2	
Geräteschutzklasse	I	
nicht für den Einsatz in explosionsgefährdeter Umgebung geeignet.		
EMV		
– Störaussendung, Störfestigkeit	EN / IEC 61326-1, Klasse B	FCC Class B
Geräuschpegel (rotorabhängig)	≤ 56 dB(A)	
Abmessungen		
– Breite	261 mm	
– Tiefe	353 mm	
– Höhe	228 mm	
Gewicht	ca. 10 kg	

6 Sicherheitshinweise



Werden nicht alle Hinweise in dieser Bedienungsanleitung befolgt, kann beim Hersteller kein Gewährleistungsanspruch geltend gemacht werden.



- Die Zentrifuge ist so aufzustellen, dass sie standsicher betrieben werden kann.
- Vor Benutzung der Zentrifuge unbedingt den Rotor auf festen Sitz prüfen.
- Während eines Zentrifugationslaufes dürfen sich gemäß EN / IEC 61010-2-020, in einem Sicherheitsbereich von 300 mm um die Zentrifuge herum, keine Personen, Gefahrstoffe und Gegenstände befinden.
- Rotoren, Gehänge und Zubehörteile, die starke Korrosionsspuren oder mechanische Schäden aufweisen, oder deren Verwendungsdauer abgelaufen ist, dürfen nicht mehr verwendet werden.
- Die Zentrifuge darf nicht mehr in Betrieb genommen werden, wenn der Schleuderraum sicherheitsrelevante Schäden aufweist.
- Bei Zentrifugen ohne Temperaturregelung kann es bei erhöhter Raumtemperatur und/oder bei häufigem Gebrauch des Gerätes zur Erwärmung des Schleuderraums kommen. Eine temperaturbedingte Veränderung des Probenmaterials kann deshalb nicht ausgeschlossen werden .

- **Vor Inbetriebnahme der Zentrifuge ist die Bedienungsanleitung zu lesen und zu beachten. Nur Personen, die die Bedienungsanleitung gelesen und verstanden haben, dürfen das Gerät bedienen.**
- Neben der Bedienungsanleitung und den verbindlichen Regelungen der Unfallverhütung sind auch die anerkannten fachtechnischen Regeln für sicherheits- und fachgerechtes Arbeiten zu beachten. Die Bedienungsanleitung ist um Anweisungen aufgrund bestehender nationaler Vorschriften des Verwenderlandes zur Unfallverhütung und zum Umweltschutz zu ergänzen.
- Die Zentrifuge ist nach dem Stand der Technik gebaut und betriebssicher. Es können aber von ihr Gefahren für den Benutzer oder Dritte ausgehen, wenn sie nicht von geschultem Personal oder unsachgemäß oder zu nicht bestimmungsgemäßem Gebrauch eingesetzt wird.
- Die Zentrifuge darf während des Betriebs nicht bewegt oder angestoßen werden.
- Im Störfall bzw. bei der Notentriegelung nie in den sich drehenden Rotor greifen.
- Um Schäden durch Kondensat zu vermeiden, muss bei Wechsel von einem kalten in einen warmen Raum, die Zentrifuge entweder mindestens 3 Stunden im warmen Raum aufwärmen bevor sie an das Netz angeschlossen werden darf oder 30 Minuten im kalten Raum warmlaufen.
- Es darf nur der vom Hersteller für dieses Gerät zugelassene Rotor und das zugelassene Zubehör verwendet werden (siehe Kapitel "Anhang/Appendix, Rotoren und Zubehör/Rotors and accessories"). Bevor Zentrifugiergefäße verwendet werden, die nicht in Kapitel "Anhang/Appendix, Rotoren und Zubehör/Rotors and accessories" aufgeführt sind, hat sich der Benutzer beim Hersteller zu vergewissern, ob diese verwendet werden dürfen.
- Der Rotor der Zentrifuge darf nur entsprechend dem Kapitel "Beladen des Rotors" beladen werden.
- Bei der Zentrifugation mit maximaler Drehzahl darf die Dichte der Stoffe oder Stoffgemische $1,2 \text{ kg/dm}^3$ nicht überschreiten.
- Zentrifugationen mit unzulässiger Unwucht sind nicht erlaubt.
- Die Zentrifuge darf nicht in explosionsgefährdeter Umgebung betrieben werden.
- Eine Zentrifugation mit:
 - brennbaren oder explosiven Materialien
 - Materialien, die chemisch mit hoher Energie miteinander reagieren ist verboten.
- Bei der Zentrifugation von gefährlichen Stoffen bzw. Stoffgemischen, die toxisch, radioaktiv oder mit pathogenen Mikroorganismen verseucht sind, sind durch den Benutzer geeignete Maßnahmen zu treffen. Es müssen grundsätzlich Zentrifugiergefäße mit speziellen Schraubverschlüssen für gefährliche Substanzen verwendet werden. Bei Materialien der Risikogruppe 3 und 4 ist zusätzlich zu den verschließbaren Zentrifugiergefäßen ein Bio-Sicherheitssystem zu verwenden (siehe Handbuch "Laboratory Biosafety Manual" der Weltgesundheitsorganisation).

Ohne Verwendung eines Bio-Sicherheitssystems ist eine Zentrifuge im Sinne der Norm EN / IEC 61010-2-020 nicht mikrobiologisch dicht.

Für diese Zentrifuge sind keine Bio-Sicherheitssysteme erhältlich.

- Der Betrieb der Zentrifuge mit stark korrodierenden Stoffen, welche die mechanische Festigkeit von Rotoren, Gehäusen und Zubehörteilen beeinträchtigen können, ist nicht erlaubt.
- Reparaturen dürfen nur von einer vom Hersteller autorisierten Person ausgeführt werden.
- Es dürfen nur Originalersatzteile und zugelassenes Originalzubehör der Firma Andreas Hettich GmbH & Co. KG verwendet werden.
- Es gelten die folgenden Sicherheitsbestimmungen:
EN / IEC 61010-1 und EN / IEC 61010-2-020 sowie deren nationalen Abweichungen.
- Die Sicherheit und Zuverlässigkeit der Zentrifuge ist nur dann gewährleistet, wenn:
 - die Zentrifuge nach der Bedienungsanleitung betrieben wird.
 - die elektrische Installation, am Aufstellungsort der Zentrifuge, den Anforderungen von EN / IEC Festlegungen entspricht.
- Die Erfüllung länderspezifischer Vorgaben zur Arbeitssicherheit bezüglich des Einsatzes von Laborzentrifugen an den vom Betreiber dafür vorgesehenen Arbeitsplätzen liegt im Verantwortungsbereich des Betreibers.

7 Transport und Lagerung

7.1 Transport



Die Transportsicherung muss, vor dem Transport des Gerätes, eingebaut werden.

Beim Transport des Gerätes und des Zubehörs müssen folgende Umgebungsbedingungen eingehalten werden:

- Umgebungstemperatur: -20°C bis $+60^{\circ}\text{C}$
- Relative Luftfeuchtigkeit: 20% bis 80%, nicht kondensierend

7.2 Lagerung



Das Gerät und das Zubehör dürfen nur in geschlossenen und trockenen Räumen gelagert werden.

Bei der Lagerung des Gerätes und des Zubehörs müssen folgende Umgebungsbedingungen eingehalten werden:

- Umgebungstemperatur: -20°C bis $+60^{\circ}\text{C}$
- Relative Luftfeuchtigkeit: 20% bis 80%, nicht kondensierend

8 Lieferumfang

Folgendes Zubehör wird mit der Zentrifuge geliefert:

- 1 Anschlusskabel
- 2 Sicherungen
- 1 Sechskant-Stiftschlüssel
- 1 Bedienungsanleitung
- 1 Hinweisblatt Transportsicherung
- 1 Hinweisblatt Notentriegelung

Rotor(en) und das entsprechende Zubehör werden je nach Bestellung mitgeliefert.

9 Transportsicherung entfernen



Die Transportsicherung muss unbedingt entfernt werden.
Die Transportsicherung aufbewahren, da sie vor dem Transport des Gerätes, wieder eingebaut werden muss.
Das Gerät darf nur mit eingebauter Transportsicherung transportiert werden.

Um das Gerät während des Transports vor Beschädigungen zu schützen, wird der Motor fixiert. Diese Transportsicherung muss bei der Inbetriebnahme des Gerätes entfernt werden.

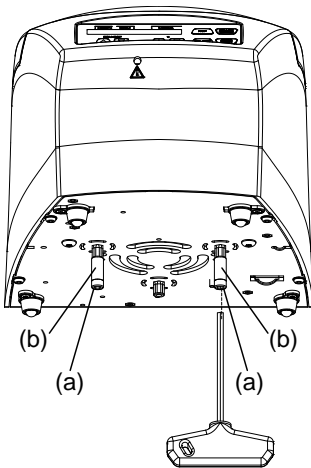

- Die beiden Schrauben (a) und Abstandshülsen (b) entfernen.



Der Einbau der Transportsicherung erfolgt in umgekehrter Reihenfolge.

10 Inbetriebnahme

- Die Transportsicherung am Gehäuseboden entfernen, siehe Kapitel "Transportsicherung entfernen".
- **Die Zentrifuge an einem geeigneten Platz standsicher aufstellen und nivellieren. Bei der Aufstellung ist der geforderte Sicherheitsbereich gemäß EN / IEC 61010-2-020, von 300 mm um die Zentrifuge herum, einzuhalten.**



Während eines Zentrifugationslaufes dürfen sich gemäß EN / IEC 61010-2-020, in einem Sicherheitsbereich von 300 mm um die Zentrifuge herum, keine Personen, Gefahrstoffe und Gegenstände befinden.

- Lüftungsöffnungen dürfen nicht zugestellt werden.
Es muss ein Abstand von 300 mm zu den Lüftungsschlitzen und Lüftungsöffnungen der Zentrifuge eingehalten werden.
- Prüfen, ob die Netzspannung mit der Angabe auf dem Typenschild übereinstimmt.
- Die Zentrifuge mit dem Netzkabel an eine genormte Netzsteckdose anschließen. Anschlusswert siehe Kapitel "Technische Daten".
- Den Netzschalter einschalten (Schalterstellung "I").
Nacheinander erscheinen folgende Anzeigen:
 1. das Zentrifugen-Modell
 2. die Typ-Nummer und die Programmversion
 3. die zuletzt benutzten Zentrifugations-Daten



Wenn der Deckel geschlossen ist, wird die Meldung "Open the lid" angezeigt.
In diesem Fall den Deckel öffnen, damit die Zentrifugations-Daten angezeigt werden.

11 Deckel öffnen und schließen

11.1 Deckel öffnen



Der Deckel lässt sich nur öffnen, wenn die Zentrifuge eingeschaltet ist und der Rotor stillsteht. Sollte dies nicht möglich sein, siehe Kapitel "Notentriegelung".



Wenn der Zyklenzähler aktiviert ist, wird nach einem Zentrifugationslauf, während dem Öffnen des Deckels, kurzzeitig die verbleibende Anzahl der Laufzyklen (Zentrifugationsläufe) angezeigt.

Beispiel:

>RCF<	RPM	t/min:s
RemCycles= 16703		



- Taste drücken.
Der Deckel entriegelt motorisch.
☑ : Deckel entriegelt.

Beispiel:

>RCF<	RPM	t/min:s
☑	4500	5:00

11.2 Deckel schließen



Mit den Fingern nicht zwischen Deckel und Gehäuse greifen.
Den Deckel nicht zuschlagen.

- Den Deckel auflegen und die Deckelvorderkante leicht niederdrücken. Der Deckel verriegelt motorisch.
☑ : Deckel verriegelt.

Beispiel:

>RCF<	RPM	t/min:s
☑	4500	5:00

12 Ein- und Ausbau des Rotors

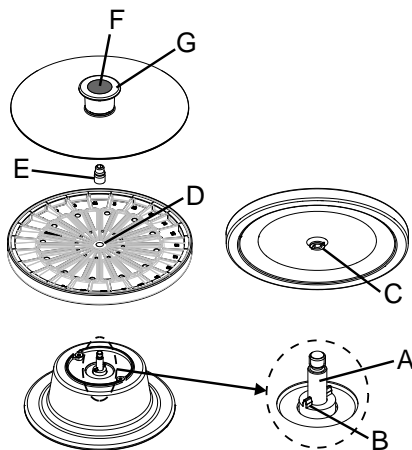

Einbau:

- Den Rotor vertikal auf die Motorwelle (A) aufsetzen und nach unten drücken. Der Mitnehmer (B) an der Motorwelle muss sich in der Nut (C) des Rotors befinden. Auf dem Rotor ist die Ausrichtung der Nut gekennzeichnet (D).
- Die Befestigungsmutter (E) mit dem mitgelieferten Sechskant-Stiftschlüssel durch Drehen im Uhrzeigersinn auf die Motorwelle (A) schrauben und festziehen.



Die Befestigungsmutter (E) muss immer fest auf der Motorwelle (A) angezogen sein.

- Den Rotor auf festen Sitz prüfen.
- Den Deckel auf den Rotor aufsetzen und am Griff soweit nach unten drücken, bis der Deckel einrastet.

Ausbau:

- Den Knopf (F) im Griff des Deckels nach unten drücken, gleichzeitig den äußeren Ring (G) des Griffes nach oben ziehen und den Deckel vom Rotor abnehmen.
- Mit dem mitgelieferten Sechskant-Stiftschlüssel die Befestigungsmutter (E) durch Drehen entgegen dem Uhrzeigersinn abschrauben und entfernen.
- Den Rotor von der Motorwelle (A) abheben.

13 Beladen des Rotors

- Den Rotor auf festen Sitz prüfen.
- Den Deckel vom Rotor abnehmen:
Den Knopf (F) im Griff des Deckels nach unten drücken, gleichzeitig den äußeren Ring (G) des Griffes nach oben ziehen und den Deckel vom Rotor abnehmen. Abbildung siehe Kapitel "Ein- und Ausbau des Rotors".
- Der Rotor darf nur symmetrisch beladen werden. Die Zentrifugiergefäße müssen gleichmäßig auf alle Plätze des Rotors verteilt werden. Zugelassene Kombinationen siehe Kapitel "Anhang/Appendix, Rotoren und Zubehör/Rotors and accessories".

Beispiel:

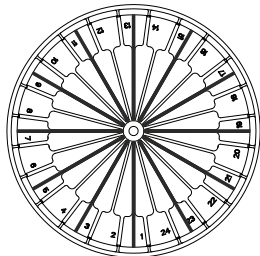

Rotor ist gleichmäßig beladen

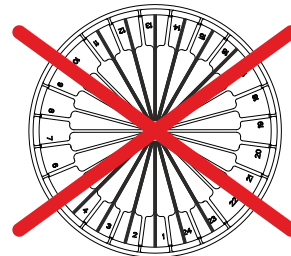

Nicht zulässig!

Rotor ist ungleichmäßig beladen

- Für die Hämatokritbestimmung werden die Kapillaren immer zu $\approx 75\%$ gefüllt.
- Beim Beladen des Rotors darf keine Flüssigkeit in den Rotor und in den Schleuderraum gelangen.
- Bei der Verwendung von Standard-Kapillarröhrchen, diese mit der Kittseite nach außen, in den Rotor einlegen. Bei der Verwendung von selbstdichtenden Kapillarröhrchen, diese mit dem Stopfenende nach außen, in den Rotor einlegen.
- Nach dem Beladen des Rotors den Deckel auf den Rotor aufsetzen und am Griff soweit nach unten drücken, bis der Deckel einrastet.

14 Bedien- und Anzeigeelemente

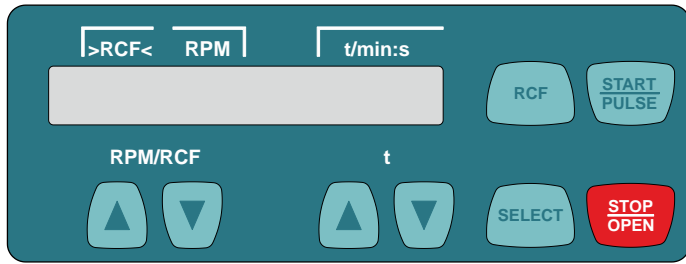

14.1 Angezeigte Symbole



Deckel entriegelt.



Deckel verriegelt.



Rotationsanzeige. Die Rotationsanzeige leuchtet rotierend gegen den Uhrzeigersinn auf, solange sich der Rotor dreht.

14.2 Tasten des Bedienfeldes

RPM/RCF



- Die Drehzahl direkt eingeben.
- Bei Gedrückthalten der Taste ändert sich der Wert mit zunehmender Geschwindigkeit.

t



- Die Laufzeit direkt eingeben. Einstellbar bis 1 Minute in 1 Sekunden-Schritten und ab 1 Minute in 1 Minuten-Schritten.
- Die Zentrifugations-Parameter eingeben.
- Bei Gedrückthalten der Taste ändert sich der Wert mit zunehmender Geschwindigkeit.



- Wähltaste zum Anwählen der einzelnen Parameter. Durch jeden weiteren Tastendruck wird der nachfolgende Parameter angewählt.
- Das "MACHINE MENU" aufrufen (die Taste 8 Sekunden gedrückt halten).
- Im "Machine Menu" die Menüs "→ Info", "→ Settings" und "→ Time & Cycles" auswählen.
- In den Menüs vorwärts blättern.



- Umschalten zwischen RPM-Anzeige (RPM) und RCF-Anzeige (>RCF<). RCF-Werte werden in Klammern >< angezeigt.
- RPM : Drehzahl
- RCF : Relative Zentrifugalbeschleunigung



- Den Zentrifugationslauf starten.
- Kurzzeitzentrifugation. Der Zentrifugationslauf erfolgt, solange die Taste gedrückt gehalten wird.
- Die Menüs "→ Info", "→ Settings" und "→ Time & Cycles" aufrufen.



- Den Zentrifugationslauf beenden. Der Rotor läuft mit vorgewählter Bremsstufe aus. Zweimaliges Drücken der Taste löst den Not-Stopp aus.
- Den Deckel entriegeln.

hhj

14.3 Einstellmöglichkeiten

t/min **Laufzeit.** Einstellbar von 1 - 99 min, in 1 Minuten-Schritten.

t/sec **Laufzeit.** Einstellbar von 1 - 59 s, in 1 Sekunden-Schritten.

Dauerlauf "--:--". Parameter **t/min** und **t/sec** auf Null stellen.

RPM **Drehzahl**

Einstellbar ist ein Zahlenwert von 200 RPM bis zur maximalen Drehzahl des Rotors.
Einstellbar von 200 RPM bis 10000 RPM in 10er Schritten und über 10000 RPM in 100er Schritten.
Maximale Drehzahl des Rotors siehe Kapitel "Anhang/Appendix, Rotoren und Zubehör/Rotors and accessories".

>RCF< **Relative Zentrifugalbeschleunigung**

Einstellbar ist ein Zahlenwert, der eine Drehzahl zwischen 200 RPM und der maximalen Drehzahl des Rotors ergibt.

Einstellbar bis 10000 in 1er Schritten und über 10000 in 10er Schritten.



Die Eingabe der relativen Zentrifugalbeschleunigung (RCF) ist nur möglich, wenn die RCF-Anzeige (>RCF<) angewählt ist.

Die relative Zentrifugalbeschleunigung (RCF) ist vom Zentrifugerradius (RAD) abhängig. Nach der Eingabe der RCF überprüfen, dass der korrekte Zentrifugerradius eingestellt ist.

RAD/mm **Zentrifugerradius**

Einstellbar von 10 mm bis 250 mm, in 1 Millimeter-Schritten.

Zentrifugerradius siehe Kapitel "Anhang/Appendix, Rotoren und Zubehör/Rotors and accessories".







Die Eingabe des Zentrifugerradius ist nur möglich, wenn die RCF-Anzeige (>RCF<) angewählt ist.

~_DEC **Bremsstufe.** **fast** = kurze Auslaufzeit, **slow** = lange Auslaufzeit.

15 Zentrifugations-Parameter eingeben

15.1 Direkte Eingabe der Zentrifugations-Parameter

Die Drehzahl (RPM), die relative Zentrifugalbeschleunigung (RCF), der Zentrifugerradius (RAD) und die Laufzeit können direkt mit den Tasten   eingegeben werden, ohne dass zuvor die Taste  gedrückt werden muss.

 Die eingestellten Zentrifugations-Parameter werden erst nach Start des Zentrifugationslaufes gespeichert.

15.1.1 Drehzahl (RPM)



- Bei Bedarf die Taste drücken, um die RPM-Anzeige (RPM) anzuwählen.

Beispiel:

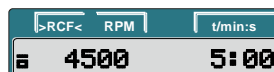

- Mit den Tasten den gewünschten Wert einstellen.

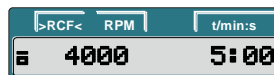

15.1.2 Relative Zentrifugalbeschleunigung (RCF) und Zentrifugerradius (RAD)



- Bei Bedarf die Taste drücken, um die RCF-Anzeige (>RCF<) anzuwählen.

Beispiel:

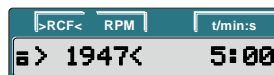

- Mit den Tasten den gewünschten RCF-Wert einstellen.



- Bei Bedarf mit den Tasten den gewünschten Zentrifugerradius einstellen.

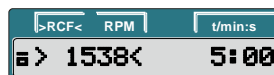

15.1.3 Laufzeit

 Die Laufzeit kann bis 1 Minute in 1 Sekunden-Schritten und ab 1 Minute nur in 1 Minuten-Schritten eingestellt werden.

Um den Dauerlauf einzustellen müssen die Parameter **t/min** und **t/sec** auf Null gestellt werden. In der Zeit-Anzeige (t/min:s) erscheint "--:--".

Beispiel:



Beispiel:



- Mit den Tasten den gewünschten Wert einstellen.

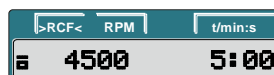

15.2 Eingabe der Zentrifugations-Parameter mit der Taste "SELECT"



Die Laufzeit kann in Minuten und Sekunden eingestellt werden (Parameter **t/min** und **t/sec**).

Um den Dauerlauf einzustellen müssen die Parameter **t/min** und **t/sec** auf Null gestellt werden. In der Zeit-Anzeige (t/min:s) erscheint "--:--".

Beispiel:



Die relative Zentrifugalbeschleunigung (RCF) ist vom Zentrifugerradius (RAD) abhängig. Während der Eingabe der RCF wird der eingestellte Zentrifugerradius angezeigt.

Wird nach der Anwahl oder während der Eingabe von Parametern 8 Sekunden lang keine Taste gedrückt, werden in der Anzeige wieder die vorherigen Werte angezeigt. Die Eingabe der Parameter muss dann erneut durchgeführt werden.

Durch Drücken der Taste  werden die Einstellungen gespeichert.

Bei Eingabe von mehreren Parametern muss die Taste  erst nach der Einstellung des letzten Parameters gedrückt werden.

Die Eingabe der Parameter kann jederzeit durch Drücken der Taste  abgebrochen werden. In diesem Fall werden die Einstellungen nicht gespeichert.



- Bei Bedarf die Taste drücken, um die RPM-Anzeige (RPM) oder die RCF-Anzeige (>RCF<) anzuwählen.



- Die Taste drücken. **t/min** : Laufzeit, Minuten.



- Mit den Tasten den gewünschten Wert einstellen.



- Die Taste drücken. **t/sec** : Laufzeit, Sekunden.



- Mit den Tasten den gewünschten Wert einstellen.







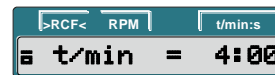
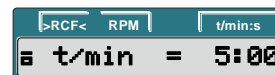
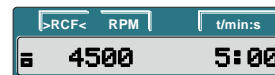



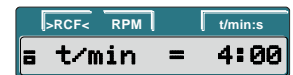
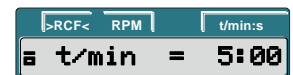
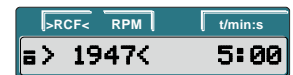



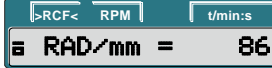

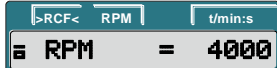
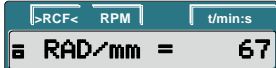

Fortsetzung nächste Seite

Beispiel:
RPM-Anzeige (RPM)



Beispiel:
RCF-Anzeige (>RCF<)



SELECT	<ul style="list-style-type: none"> Die Taste drücken. RPM : Drehzahl. RAD/mm : Zentrifugerradius. Die Anzeige und Eingabe des Zentrifugerradius ist nur möglich, wenn die RCF-Anzeige (>RCF<) angewählt ist. 	Beispiel: RPM-Anzeige (RPM)		Beispiel: RCF-Anzeige (>RCF<)	
	<ul style="list-style-type: none"> Mit den Tasten den gewünschten Wert einstellen. 				
SELECT	<ul style="list-style-type: none"> Die Taste drücken. R : Zentrifugerradius. RCF : Relative Zentrifugalbeschleunigung. 				
	<ul style="list-style-type: none"> Mit den Tasten den gewünschten Wert einstellen. 				
SELECT	<ul style="list-style-type: none"> Die Taste drücken. _DEC : Bremsstufe. fast : kurze Auslaufzeit. slow : lange Auslaufzeit. 				
	<ul style="list-style-type: none"> Mit den Tasten den gewünschten Wert einstellen. 				
START PULSE	<ul style="list-style-type: none"> Die Taste drücken, um die Einstellungen zu speichern. 				

Fortsetzung nächste Seite

16 Zentrifugation

 Während eines Zentrifugationslaufes dürfen sich gemäß EN / IEC 61010-2-020, in einem Sicherheitsbereich von 300 mm um die Zentrifuge herum, keine Personen, Gefahrstoffe und Gegenstände befinden.

 Wurde der zulässige Gewichtsunterschied innerhalb der Beladung des Rotors überschritten, wird der Zentrifugationslauf während des Anlaufs abgebrochen und es erscheint folgende Anzeige:



Ein Zentrifugationslauf kann jederzeit durch Drücken der Taste  abgebrochen werden.

Während eines Zentrifugationslaufes können Zentrifugations-Parameter angewählt und geändert werden. Die geänderten Werte sind jedoch nur für den aktuellen Zentrifugationslaufes gültig und werden nicht gespeichert.

Mit der Taste  kann jederzeit zwischen der RPM-Anzeige (RPM) und der RCF-Anzeige (>RCF<) umgeschaltet werden. Wird mit der RCF-Anzeige (>RCF<) gearbeitet, ist die Eingabe des Zentrifugierradius notwendig.

Erscheint folgende Anzeige















so ist eine weitere Bedienung der Zentrifuge erst nach Öffnen des Deckels möglich.

Bedienfehler und Störungen werden angezeigt (siehe Kapitel "Störungen").

- Den Netzschalter einschalten. Schalterstellung I.
- Den Rotor beladen und den Zentrifugendeckel schließen.

16.1 Zentrifugation mit Zeitvorwahl

<p> • Bei Bedarf die Taste drücken, um die RPM-Anzeige (RPM) oder die RCF-Anzeige (>RCF<) anzuwählen.</p> <p>↓</p> <p>• Die gewünschten Zentrifugations-Parameter eingeben (siehe Kapitel "Zentrifugations-Parameter eingeben").</p> <p>↓</p> <p> • Die Taste drücken, um den Zentrifugationslauf zu starten. Während des Zentrifugationslaufes werden die Drehzahl des Rotors oder der daraus resultierende RCF-Wert, und die verbleibende Zeit angezeigt.</p> <p>↓</p> <p>• Nach Ablauf der Zeit oder bei Abbruch des Zentrifugationslaufes durch Drücken der Taste , erfolgt der Auslauf mit der eingestellten Bremsstufe. Die Bremsstufe wird angezeigt. Beispiel </p> <p>Fortsetzung nächste Seite</p>	<p>Beispiel: RPM-Anzeige (RPM)</p>    	<p>Beispiel: RCF-Anzeige (>RCF<)</p>    
---	--	--

16.2 Dauerlauf



- Bei Bedarf die Taste drücken, um die RPM-Anzeige (RPM) oder die RCF-Anzeige (>RCF<) anzuwählen.



- Die gewünschten Zentrifugations-Parameter eingeben. Die Parameter *t/min* und *t/sec* auf Null stellen (siehe Kapitel "Zentrifugations-Parameter eingeben").



- Die Taste drücken, um den Zentrifugationslauf zu starten. Während des Zentrifugationslaufes werden die Drehzahl des Rotors oder der daraus resultierende RCF-Wert, und die gelaufene Zeit angezeigt.



- Die Taste drücken, um den Zentrifugationslauf zu beenden. Der Auslauf erfolgt mit der eingestellten Bremsstufe. Die Bremsstufe wird angezeigt. Beispiel $\sim f$

Beispiel: RPM-Anzeige (RPM)

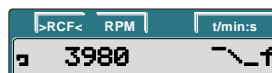
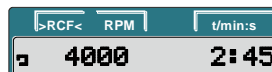

Beispiel: RCF-Anzeige (>RCF<)

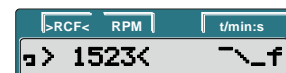

16.3 Kurzzeitentrifugation



- Bei Bedarf die Taste drücken, um die RPM-Anzeige (RPM) oder die RCF-Anzeige (>RCF<) anzuwählen.



- Die gewünschten Zentrifugations-Parameter eingeben (siehe Kapitel "Zentrifugations-Parameter eingeben").



- Die Taste drücken und gedrückt halten. Während des Zentrifugationslaufes werden die Drehzahl des Rotors oder der daraus resultierende RCF-Wert, und die gelaufene Zeit angezeigt.



- Die Taste wieder loslassen um den Zentrifugationslauf zu beenden. Der Auslauf erfolgt mit der eingestellten Bremsstufe. Die Bremsstufe wird angezeigt. Beispiel $\sim f$.

Beispiel: RPM-Anzeige (RPM)

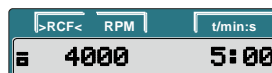
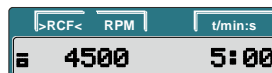

Beispiel: RCF-Anzeige (>RCF<)

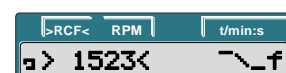
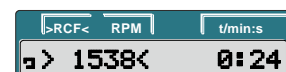
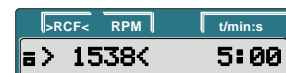
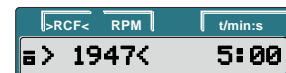

Fortsetzung nächste Seite

17 Not-Stopp



- Die Taste zweimal drücken.
Beim Not-Stopp erfolgt der Auslauf mit Bremsstufe "fast" (kurze Auslaufzeit). Die Bremsstufe `_f` wird angezeigt.

Beispiel: RPM-Anzeige (RPM)

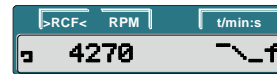

Beispiel: RCF-Anzeige (>RCF<)



18 Einstellungen und Abfragen

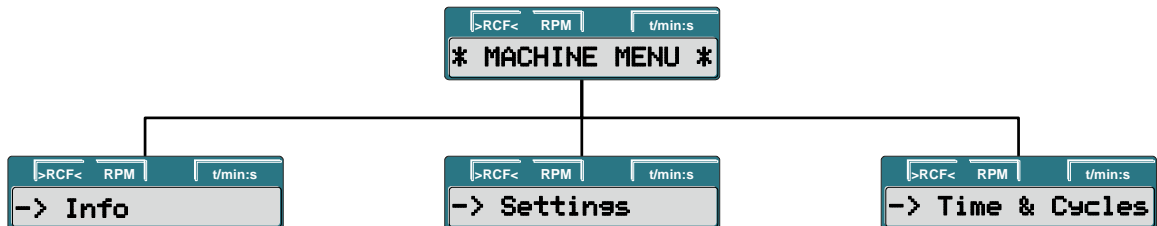

Abfrage:

- System-Informationen

Einstellung:

- Akustisches Signal
- Automatisches Entriegeln des Deckels nach dem Zentrifugationslauf
- Automatische Abschaltung der Hintergrundbeleuchtung
- Optisches Signal nach Beendigung des Zentrifugationslaufes

Abfrage:

- Betriebsstunden
- Anzahl der durchgeführten Zentrifugationsläufe

18.1 System-Informationen abfragen

Folgende System-Informationen können abgefragt werden:

- Geräte-Modell,
- Programmversion des Gerätes,
- Typ-Nummer des Gerätes,
- Herstellungsdatum des Gerätes,
- Seriennummer des Gerätes,
- Typ des Frequenzumrichters,
- Programmversion des Frequenzumrichters

Die Abfrage kann, bei Stillstand des Rotors, wie folgt durchgeführt werden:

Der Vorgang kann jederzeit durch Drücken der Taste  abgebrochen werden.



- Die Taste 8 Sekunden gedrückt halten.



- Die Taste drücken.



- Die Taste drücken.
Geräte-Modell



- Die Taste drücken.
Programmversion des Gerätes.

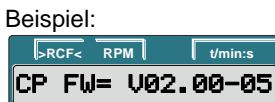

- Die Taste drücken.
Type#1 : Typ-Nummer des Gerätes.



- Die Taste drücken.
Type#2 : Fortsetzung der Typ-Nummer,
wenn diese mehr Stellen als das Anzeigefeld "**Type#1**" hat.



- Die Taste drücken.
Herstellungsdatum des Gerätes.



Fortsetzung nächste Seite



- Die Taste drücken.
Seriennummer des Gerätes.

Beispiel:



- Die Taste drücken.
Typ des Frequenzumrichters.

Beispiel:



- Die Taste drücken.
Programmversion des Frequenzumrichters.

Beispiel:



- Die Taste zweimal drücken, um das Menü "→ Info" zu verlassen oder dreimal drücken, um das "* MACHINE MENU *" zu verlassen.



Beispiel:





18.2 Akustisches Signal

Das akustische Signal ertönt:

- nach Auftreten einer Störung im 2 s-Intervall.
- nach Beendigung des Zentrifugationslaufes und Stillstand des Rotors im 30 s-Intervall.

Durch Drücken einer beliebigen Taste wird das akustische Signal beendet.

Das akustische Signal kann, bei Stillstand des Rotors, wie folgt eingestellt werden:

 Der Vorgang kann jederzeit durch Drücken der Taste  abgebrochen werden. In diesem Fall werden die Einstellungen nicht gespeichert.

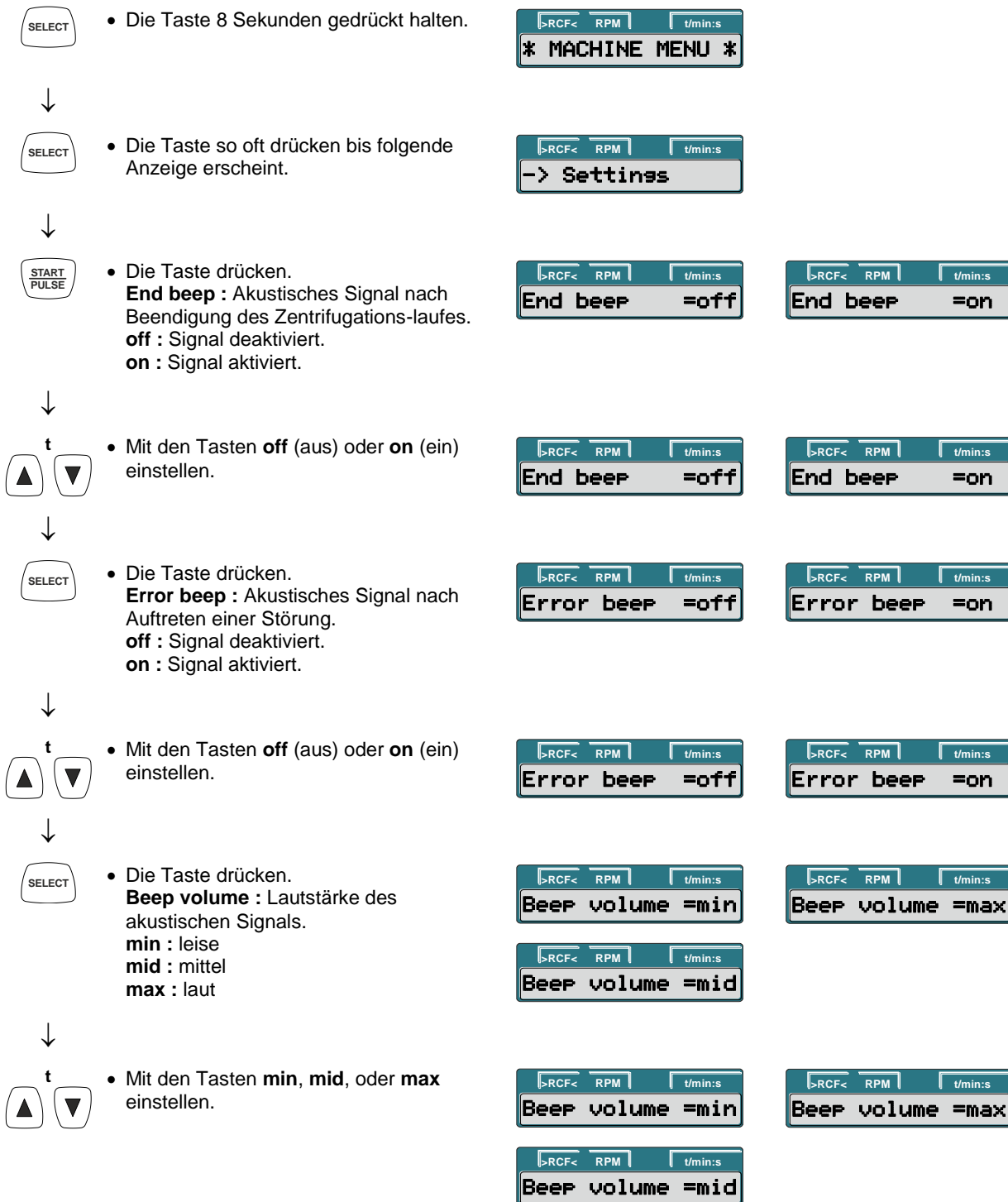

Fortsetzung nächste Seite



- Die Taste drücken, um die Einstellung zu speichern.



- Die Taste einmal drücken, um das Menü "-> Settings" zu verlassen oder zweimal drücken, um das "* MACHINE MENU *" zu verlassen.



Beispiel:



18.3 Optisches Signal nach Beendigung des Zentrifugationslaufes

Die Hintergrundbeleuchtung der Anzeige blinkt nach dem Zentrifugationslauf, um optisch zu signalisieren, dass der Zentrifugationslauf beendet ist.

Das optische Signal kann, bei Stillstand des Rotors, wie folgt ein- oder ausgeschaltet werden:

Der Vorgang kann jederzeit durch Drücken der Taste abgebrochen werden.



- Die Taste 8 Sekunden gedrückt halten.



- Die Taste so oft drücken bis folgende Anzeige erscheint.



- Die Taste drücken.



- Die Taste so oft drücken bis eine der beiden Anzeigen erscheint.
End blinking : Blinken der Hintergrundbeleuchtung der Anzeige nach dem Zentrifugationslauf.
off : Hintergrundbeleuchtung blinkt nicht.
on : Hintergrundbeleuchtung blinkt.



- Mit den Tasten **off** (aus) oder **on** (ein) einstellen.



- Die Taste drücken, um die Einstellung zu speichern.



- Die Taste einmal drücken, um das Menü "-> Settings" zu verlassen oder zweimal drücken, um das "* MACHINE MENU *" zu verlassen.



Beispiel:



18.4 Automatisches Entriegeln des Deckels nach dem Zentrifugationslauf

Es kann eingestellt werden, ob der Deckel, nach dem Zentrifugationslauf, automatisch entriegelt oder nicht.

Bei Stillstand des Rotors kann dies wie folgt eingestellt werden:

 Der Vorgang kann jederzeit durch Drücken der Taste  abgebrochen werden. In diesem Fall werden die Einstellungen nicht gespeichert.

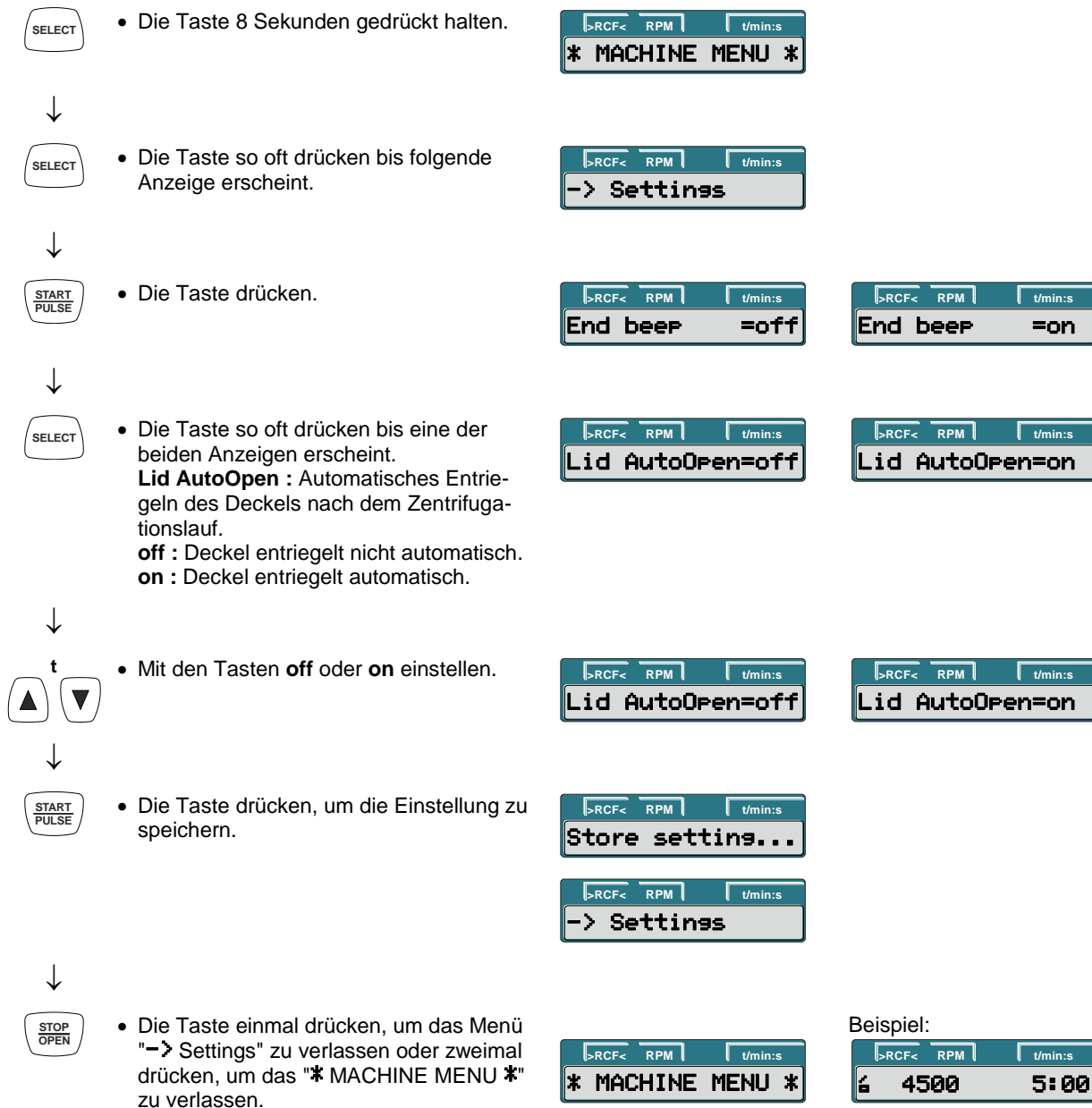

18.5 Hintergrundbeleuchtung der Anzeige

Zum Einsparen von Energie kann eingestellt werden, dass nach einem Zentrifugationslauf, die Hintergrundbeleuchtung der Anzeige nach 2 Minuten ausschaltet.

Bei Stillstand des Rotors kann dies wie folgt eingestellt werden:

 Der Vorgang kann jederzeit durch Drücken der Taste  abgebrochen werden. In diesem Fall werden die Einstellungen nicht gespeichert.

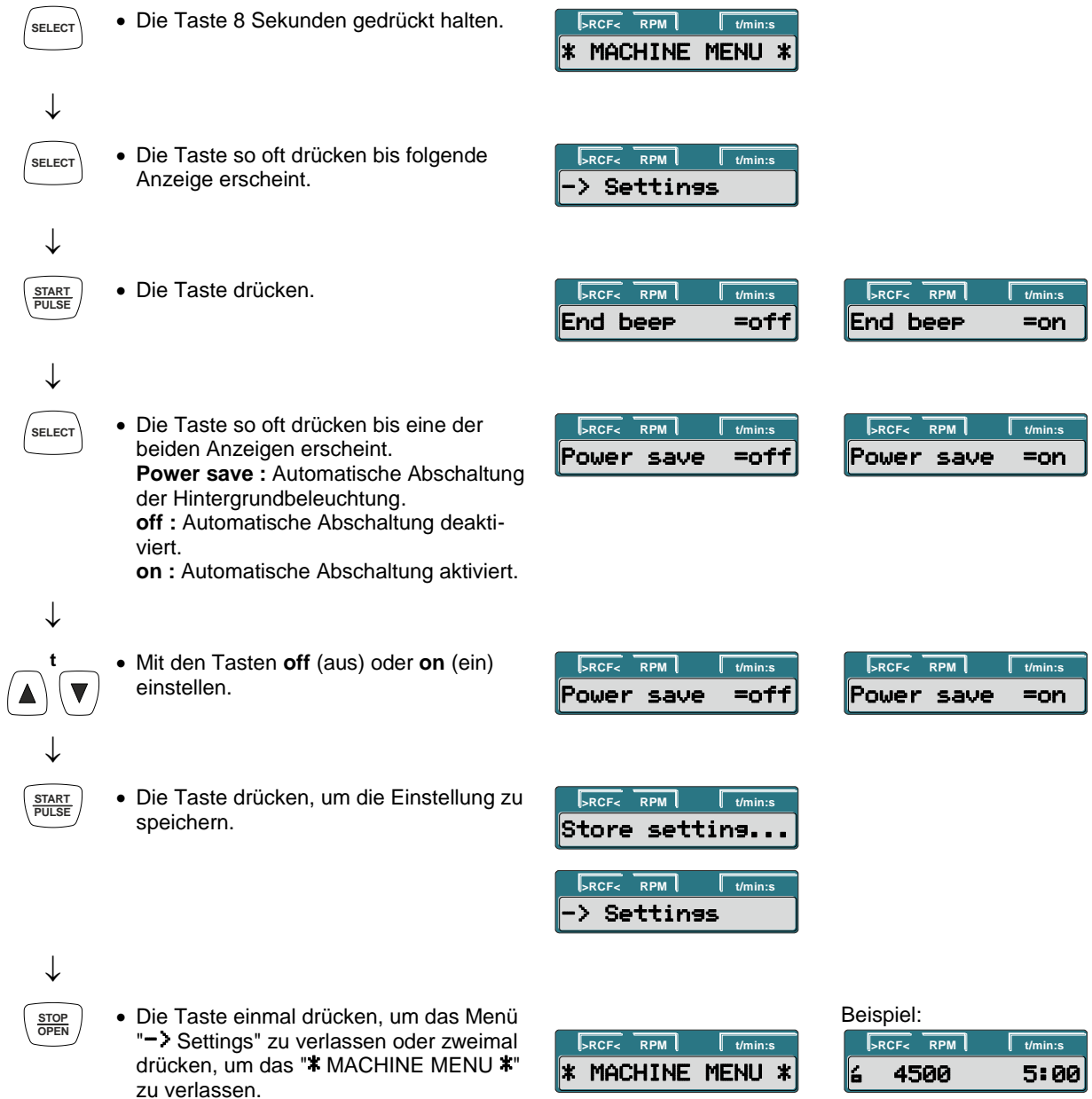

18.6 Die Betriebsstunden und die Anzahl der Zentrifugationsläufe abfragen

Die Betriebsstunden sind in interne und externe Betriebsstunden aufgeteilt.

Interne Betriebsstunden: Gesamte Zeit, die das Gerät eingeschaltet war.

Externe Betriebsstunden: Gesamte Zeit der bisherigen Zentrifugationsläufe.

Die Abfrage kann, bei Stillstand des Rotors, wie folgt durchgeführt werden:

 Der Vorgang kann jederzeit durch Drücken der Taste  abgebrochen werden.

SELECT

- Die Taste 8 Sekunden gedrückt halten.

 >RCF< RPM t/min:s
 * MACHINE MENU *



SELECT

- Die Taste so oft drücken bis folgende Anzeige erscheint.

 >RCF< RPM t/min:s
 -> Time & Cycles



START PULSE

- Die Taste drücken.
TimeExt : Externe Betriebsstunden.

Beispiel:

 >RCF< RPM t/min:s
 TimeExt= 43 h



SELECT

- Die Taste drücken.
TimeInt : Interne Betriebsstunden.

Beispiel:

 >RCF< RPM t/min:s
 TimeInt= 60 h



SELECT

- Die Taste drücken.
Starts : Anzahl aller Zentrifugationsläufe.

Beispiel:



 >RCF< RPM t/min:s
 Starts= 325



STOP OPEN

- Die Taste zweimal drücken, um das Menü "-> Time & Cycles" zu verlassen oder dreimal drücken, um das "* MACHINE MENU *" zu verlassen.

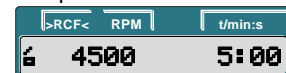
Beispiel:

 >RCF< RPM t/min:s
 4500 5:00

19 Relative Zentrifugalbeschleunigung (RCF)

Die relative Zentrifugalbeschleunigung (RCF) wird als Vielfaches der Erdbeschleunigung (g) angegeben. Sie ist ein einheitsfreier Zahlenwert und dient zum Vergleich der Trenn- und Sedimentationsleistung.

Die Berechnung erfolgt nach der Formel:

$$\text{RCF} = \left(\frac{\text{RPM}}{1000} \right)^2 \times r \times 1,118 \quad \Rightarrow \quad \text{RPM} = \sqrt{\frac{\text{RCF}}{r \times 1,118}} \times 1000$$

RCF = Relative Zentrifugalbeschleunigung

RPM = Drehzahl

r = Zentrifugerradius in mm = Abstand von der Mitte der Drehachse bis zum Zentrifugiergefäßboden.
Zentrifugerradius siehe Kapitel "Anhang/Appendix, Rotoren und Zubehör/Rotors and accessories".



Die relative Zentrifugalbeschleunigung (RCF) ist von der Drehzahl und dem Zentrifugerradius abhängig.

20 Zentrifugation von Stoffen oder Stoffgemischen mit einer höheren Dichte als 1,2 kg/dm³

Bei der Zentrifugation mit maximaler Drehzahl darf die Dichte der Stoffe oder Stoffgemische 1,2 kg/dm³ nicht überschreiten.

Bei Stoffen oder Stoffgemischen mit einer höheren Dichte muss die Drehzahl reduziert werden.

Die erlaubte Drehzahl lässt sich nach folgender Formel berechnen:

$$\text{Reduzierte Drehzahl (n}_{\text{red}}) = \sqrt{\frac{1,2}{\text{höhere Dichte [kg/dm}^3]}} \times \text{maximale Drehzahl [RPM]}$$

z.B.: Maximale Drehzahl 4000 RPM, Dichte 1,6 kg/dm³

$$n_{\text{red}} = \sqrt{\frac{1,2 \text{ kg/dm}^3}{1,6 \text{ kg/dm}^3}} \times 4000 \text{ RPM} = 3464 \text{ RPM}$$

Bei eventuellen Unklarheiten ist Auskunft beim Hersteller einzuholen.

21 Hämatokritbestimmung

21.1 Ermitteln der Zentrifugationszeit

Zum Ermitteln der Zentrifugationszeit gilt folgende Näherungsformel:

$$\frac{100000}{\text{RCF}} = \text{Zentrifugationszeit in Minuten}$$

RCF = Relative Zentrifugalbeschleunigung

Berechnung der RCF siehe Kapitel "Relative Zentrifugalbeschleunigung (RCF)".

Beispiel:

RCF = 16060

$$\frac{100000}{16060} = 6,23 \text{ Minuten} = 6 \text{ Minuten und } 14 \text{ Sekunden}$$

Bei einer RCF von 16060 beträgt die Zentrifugationszeit 6 Minuten und 14 Sekunden.

21.2 Ablesen des Hämatokritwertes

Das Ablesen des Hämatokritwertes wird wie folgt durchgeführt:

- Den Rotor festhalten.
- Die Auswertscheibe (Deckel des Rotors) drehen, bis die 100%-Linie der Auswertscheibe mit dem oberen Rand der Flüssigkeitssäule im Kapillarröhrchen übereinstimmt.
- Am oberen Rand der Erythrozytensäule den Hämatokritwert ablesen.

Den Vorgang so oft wiederholen bis alle Kapillarröhrchen ausgewertet sind.

22 Notentriegelung

Bei einem Stromausfall kann der Deckel nicht motorisch entriegelt werden. Es muss eine Notentriegelung von Hand durchgeführt werden.



Zur Notentriegelung die Zentrifuge vom Netz trennen.
Den Deckel nur bei Stillstand des Rotors öffnen.



VORSICHT! Beschädigung des Verschlusses, während der Notentriegelung, durch Drehen des Sechskant-Stiftschlüssels im Uhrzeigersinn (nach rechts).

Der Sechskant-Stiftschlüssel darf nur entgegen dem Uhrzeigersinn (nach links) gedreht werden, siehe Abbildung.

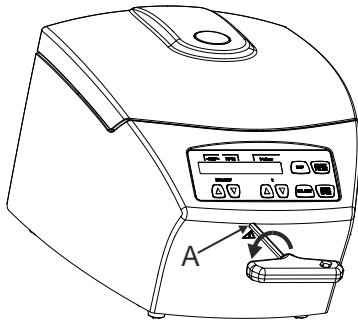

- Den Netzschalter ausschalten (Schalterstellung "0").
- Durch das Fenster im Deckel schauen, um sich zu vergewissern, dass der Rotor stillsteht.
- Den Sechskant-Stiftschlüssel waagrecht in die Bohrung (A) einführen und solange vorsichtig entgegen dem Uhrzeigersinn (nach links) drehen, bis der Deckel öffnet.
- Den Sechskant-Stiftschlüssel wieder aus der Bohrung herausziehen.

23 Pflege und Wartung



Das Gerät kann kontaminiert sein.



Vor der Reinigung den Netzstecker ziehen.

Bevor ein anderes als das vom Hersteller empfohlene Reinigungs- oder Dekontaminationsverfahren angewandt wird, hat sich der Benutzer beim Hersteller zu vergewissern, dass das vorgesehene Verfahren das Gerät nicht schädigt.

- Zentrifugen, Rotoren und das Zubehör dürfen nicht in Spülmaschinen gereinigt werden.
- Es darf nur eine Handreinigung und eine Flüssig-Desinfektion durchgeführt werden.
- Die Wassertemperatur muss 20 – 25°C betragen.
- Es dürfen nur Reinigungs- oder Desinfektionsmittel verwendet werden, die:
 - im pH-Bereich 5 - 8 liegen,
 - keine Ätzalkalien, Peroxide, Chlorverbindungen, Säuren und Laugen enthalten.
- Um Korrosionserscheinungen durch Reinigungs- oder Desinfektionsmittel zu vermeiden sind die speziellen Anwendungshinweise vom Hersteller des Reinigungs- oder Desinfektionsmittels unbedingt zu beachten.



Hämatokritrotor, Rotor-Deckel, die Polsterschalen und Dichtringe sind nicht autoklavierbar.

23.1 Zentrifuge (Gehäuse, Deckel und Schleuderraum)

23.1.1 Oberflächenreinigung und -pflege

- Das Gehäuse der Zentrifuge und den Schleuderraum regelmäßig säubern und bei Bedarf mit Seife oder einem milden Reinigungsmittel und einem feuchten Tuch reinigen. Dies dient zum einen der Hygiene und es verhindert Korrosion durch anhaftende Verunreinigungen.
- Inhaltsstoffe geeigneter Reinigungsmittel:
Seife, anionische Tenside, nichtionische Tenside.
- Nach dem Einsatz von Reinigungsmitteln, die Reste des Reinigungsmittels, durch Nachwischen mit einem feuchten Tuch, entfernen.
- Die Flächen müssen unmittelbar nach der Reinigung getrocknet werden.
- Bei Bildung von Kondenswasser den Schleuderraum, durch Auswischen mit einem saugfähigen Tuch, trocknen.
- Die Gummidichtung des Schleuderraums nach jeder Reinigung mit Talkum-Puder oder einem Gummi-Pflegemittel leicht einreiben.
- Der Schleuderraum ist jährlich auf Schäden zu überprüfen.



Werden sicherheitsrelevante Schäden festgestellt, darf die Zentrifuge nicht mehr in Betrieb genommen werden. In diesem Fall ist der Kundendienst zu benachrichtigen.

23.1.2 Oberflächendesinfektion

- Gelangt infektiöses Material in den Schleuderraum, so ist dieser umgehend zu desinfizieren.
- Inhaltsstoffe geeigneter Desinfektionsmittel:
Äthanol, n-Propanol, Ethylhexanol, anionische Tenside, Korrosionsinhibitoren.
- Nach dem Einsatz von Desinfektionsmitteln, die Reste des Desinfektionsmittels, durch Nachwischen mit einem feuchten Tuch, entfernen.
- Die Flächen müssen unmittelbar nach der Desinfektion getrocknet werden.

23.1.3 Entfernen radioaktiver Verunreinigungen

- Das Mittel muss speziell für das Entfernen radioaktiver Verunreinigungen ausgewiesen sein.
- Inhaltsstoffe geeigneter Mittel für das Entfernen radioaktiver Verunreinigungen:
Anionische Tenside, nichtionische Tenside, polyhydrierter Äthanol.
- Nach dem Entfernen der radioaktiven Verunreinigungen, die Reste des Mittels, durch Nachwischen mit einem feuchten Tuch, entfernen.
- Die Flächen müssen unmittelbar nach dem Entfernen der radioaktiven Verunreinigungen getrocknet werden.

23.2 Reinigen und Desinfizieren des Hämatokritrotors

Sollten trotz aller Vorsichtsmaßnahmen doch einmal Hämatokritkapillaren während der Zentrifugation auslaufen, müssen Rotor und Deckel gereinigt werden. Dafür bitte folgendermaßen vorgehen:

- Polsterschalen oder Dichtring vorsichtig aus dem Hämatokritrotor herausnehmen.
- Hämatokritrotor, Deckel, sowie die Polsterschalen oder den Dichtring in kaltes Wasser einlegen, bis sich die Blutreste vollständig gelöst haben.
- Eine geeignete Desinfektion durchführen. Die Anwendung von Desinfektionsmitteln ist beim Deckel möglichst zu vermeiden, da sich der Aufdruck lösen kann.
Inhaltsstoffe geeigneter Desinfektionsmittel: Glutaraldehyd, Propanol, Ethylhexanol, anionische Tenside, Korrosionsinhibitoren.
Inhaltsstoffe geeigneter Mittel für das Entfernen radioaktiver Verunreinigungen: Anionische Tenside, nichtionische Tenside, polyhydrierter Äthanol.
- Die Teile in kaltem Wasser abspülen und abtrocknen.
- Sie können nun wieder in die Zentrifuge eingesetzt werden.

23.3 Vorgehen bei zerbrochenen Hämatokritkapillaren



Verletzungsgefahr!

Am besten mit doppelten Handschuhen arbeiten. Wegen eventuell wegspritzender Glassplitter Sicherheitsbrille und Mundschutz tragen!

- Deckel des Hämatokritrotors vorsichtig abnehmen.
- Größere Kapillarstücke mit der Pinzette entfernen.
- Rotor herausnehmen. Die betroffenen Polsterschalen oder den Dichtring vorsichtig und langsam mit der Pinzette herausziehen und austauschen.
- Reinigen und Desinfizieren wie oben beschrieben.

23.3.1 Rotoren und Zubehör mit begrenzter Verwendungsdauer

Die Verwendung des Rotors, Bestellnummer 2076, ist zeitlich begrenzt.

Das Ablaufdatum ist auf dem Rotor ersichtlich, zum Beispiel: "einsetzbar bis Ende: IV. Quartal 2019 / usable until end of: IV. Quartal 2019".



Aus Sicherheitsgründen darf der Rotor nicht mehr verwendet werden, wenn das darauf gekennzeichnete Ablaufdatum erreicht ist.

24 Störungen



Lässt sich der Fehler laut Störungstabelle nicht beheben, so ist der Kundendienst zu benachrichtigen.

Bitte den Zentrifugentyp und die Seriennummer angeben. Beide Nummern sind auf dem Typenschild der Zentrifuge ersichtlich.



Einen NETZ-RESET durchführen:

- Den Netzschalter ausschalten (Schalterstellung "0").
- Mindestens 10 Sekunden lang warten und anschließend den Netzschalter wieder einschalten (Schalterstellung "I").

Anzeige		Ursache	Beseitigung
keine Anzeige		keine Spannung. Netzeingangssicherungen defekt.	<ul style="list-style-type: none"> - Versorgungsspannung überprüfen. - Netzeingangssicherungen überprüfen, siehe Kapitel "Netzeingangssicherungen wechseln". - Netzschalter EIN.
IMBALANCE		Der Rotor ist ungleichmäßig beladen.	<ul style="list-style-type: none"> - Nach Stillstand des Rotors den Deckel öffnen. - Die Beladung des Rotors überprüfen, siehe Kapitel "Beladen des Rotors". - Den Zentrifugationslauf wiederholen.
MAINS INTER	11	Netzunterbrechung während des Zentrifugationslaufes. (Der Zentrifugationslauf wurde nicht beendet.)	<ul style="list-style-type: none"> - Nach Stillstand des Rotors den Deckel öffnen. - Taste  drücken. - Bei Bedarf den Zentrifugationslauf wiederholen.
MAINS INTERRUPT			
TACHO ERROR	1, 2	Ausfall der Drehzahlimpulse.	<ul style="list-style-type: none"> - Nach Stillstand des Rotors einen NETZ-RESET durchführen.
LID ERROR	4.1 – 4.127	Fehler Deckelverriegelung	
OVER SPEED	5	Überdrehzahl	
VERSION ERROR	12	Falsches Zentrifugen-Modell erkannt. Fehler / Defekt Elektronik	<ul style="list-style-type: none"> - Nach Stillstand des Rotors einen NETZ-RESET durchführen.
UNDER SPEED	13	Unterdrehzahl	
CTRL ERROR	25.1, 25.2	Fehler / Defekt Elektronik	
CRC ERROR	27.1		
COM ERROR	31 – 36		
FC ERROR	60, 61.1 – 61.21, 61.64 – 61.142		
FC ERROR	61.23	Fehler Drehzahlmessung	<ul style="list-style-type: none"> - Das Gerät darf nicht ausgeschaltet werden, solange die Rotationsanzeige  rotierend aufleuchtet. Warten bis das Symbol  (Deckel verriegelt) angezeigt wird (nach ca. 120 Sekunden). Anschließend einen NETZ-RESET durchführen.
TACHO ERR	61.22		
FC ERROR	61.153	Fehler / Defekt Elektronik	<ul style="list-style-type: none"> - Einen NETZ-RESET durchführen. - Die Beladung des Rotors überprüfen, siehe Kapitel "Beladen des Rotors". - Den Zentrifugationslauf wiederholen.

25 Netzeingangssicherungen wechseln



Den Netzschalter ausschalten und das Gerät vom Netz trennen!

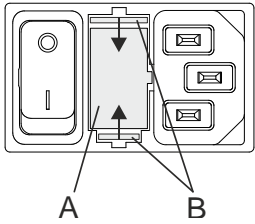

Der Sicherungshalter (A) mit den Netzeingangssicherungen befindet sich neben dem Netzschalter.

- Das Anschlusskabel aus dem Gerätestecker ziehen.
- Den Schnappverschluss (B) gegen den Sicherungshalter (A) drücken und diesen herausziehen.
- Defekte Netzeingangssicherungen austauschen.



Nur Sicherungen mit dem, für den Typ, festgelegten Nennwert verwenden, siehe nachfolgende Tabelle.

- Den Sicherungshalter wieder hineinschieben bis der Schnappverschluss einrastet.
- Das Gerät wieder ans Netz anschließen.

Modell	Typ	Sicherung	Best.-Nr.
HAEMATOKRIT 200	1801	T 3,15 AH/250V	E997
HAEMATOKRIT 200	1801-01	T 6,3 AH/250V	2266

26 Rücksendung von Geräten



Vor der Rücksendung des Gerätes muss die Transportsicherung eingebaut werden.

Wird das Gerät oder dessen Zubehör an die Firma Andreas Hettich GmbH & Co. KG zurückgesandt, so muss dieses, zum Schutz von Personen, Umwelt und Material, vor dem Versand dekontaminiert und gereinigt werden.

Eine Annahme von kontaminierten Geräten oder Zubehör behalten wir uns vor.

Anfallende Kosten für Reinigungs- und Desinfektionsmaßnahmen werden dem Kunden in Rechnung gestellt.

Wir bitten dafür um Ihr Verständnis.

27 Entsorgung

Vor der Entsorgung muss das Gerät, zum Schutz von Personen, Umwelt und Material, dekontaminiert und gereinigt werden.

Bei der Entsorgung des Geräts sind die jeweiligen gesetzlichen Vorschriften zu beachten.

Gemäß der Richtlinie 2002/96/EG (WEEE) dürfen alle nach dem 13.08.2005 gelieferten Geräte nicht mehr mit dem Hausmüll entsorgt werden. Das Gerät gehört zur Gruppe 8 (Medizinische Geräte) und ist in den Business-to-Business-Bereich eingeordnet.



Mit dem Symbol des durchgestrichenen Abfalleimers wird darauf hingewiesen, dass das Gerät nicht mit dem Hausmüll entsorgt werden darf.

Die Entsorgungsvorschriften der einzelnen EU-Länder können unterschiedlich sein. Im Bedarfsfall wenden Sie sich bitte an Ihren Lieferanten.

Contents

1	How to use these operating instructions	41
2	Symbol meanings	41
3	Intended use	41
4	Remaining risks	41
5	Technical specifications	42
6	Notes on safety	43
7	Transport and storage	44
7.1	Transport	44
7.2	Storage	44
8	Scope of delivery	44
9	Removing the transport securing device	45
10	Initial operation	45
11	Opening and closing the lid	46
11.1	Opening the lid	46
11.2	Closing the lid	46
12	Installation and removal of the rotor	47
13	Loading the rotor	47
14	Operating and display elements	48
14.1	Displayed symbols	48
14.2	Control panel keys	48
14.3	Setting options	49
15	Entering centrifugation parameters	50
15.1	Direct input of the centrifugation parameters	50
15.1.1	Speed (RPM)	50
15.1.2	Relative centrifugal force (RCF) and centrifugal radius (RAD)	50
15.1.3	Runtime	50
15.2	Input of the centrifugation parameters with the "SELECT" key	51
16	Centrifugation	53
16.1	Centrifugation with preset time	53
16.2	Continuous run	54
16.3	Short-term centrifugation	54
17	Emergency Stop	55
18	Settings and queries	55
18.1	Querying system information	56
18.2	Acoustic signal	58
18.3	Optical signal after ending the centrifugation run	59
18.4	Automatic unlocking of the lid after the centrifugation run	60
18.5	Backlighting of the display	61
18.6	Querying the hours of operation and the number of centrifugation runs	62
19	Relative centrifugal force (RCF)	63
20	Centrifugation of materials or mixtures of materials with a density higher than 1.2 kg/dm ³	63
21	Haematocrit measurement	63
21.1	Determining the centrifugation time	63

21.2	Reading off the hematocrit value	63
22	Emergency unlocking	64
23	Maintenance and servicing.....	64
23.1	Centrifuge (housing, lid and centrifuging chamber).....	65
23.1.1	Surface cleaning and care	65
23.1.2	Surface disinfection	65
23.1.3	Removal of radioactive contaminants	65
23.2	Cleaning and disinfecting the haematocrit rotor.....	65
23.3	Procedure in case of broken haematocrit capillaries.....	66
23.3.1	Rotors and accessories with limited service lives	66
24	Faults	67
25	Change mains input fuses.....	68
26	Returning Devices.....	68
27	Disposal	68
28	Anhang / Appendix.....	130
28.1	Rotoren und Zubehör / Rotors and accessories.....	130

1 How to use these operating instructions

- Before using the centrifuge, read the operating instructions and observe them.
- The operating instructions are a part of the device. They must always be kept readily available.
- If the device is set up at a different location, the operating instructions must be provided with it.

2 Symbol meanings



Symbol on the device:
Attention, general hazard area.



Symbol on the device:
Observe operating instructions.
This symbol indicates that the user must observe the operating instructions provided.



Symbol in this document:
Attention, general hazard area.
This symbol refers to safety relevant warnings and indicates possibly dangerous situations.
The non-adherence to these warnings can lead to material damage and injury to personal.



Symbol on the device and in this document:
Beware of biohazard.



Symbol in this document:
This symbol refers to important circumstances.



Symbol on the device:
The symbol is on the housing, near the hinge.
Direction of rotation of the rotor.



Symbol on the device:
The symbol is located on the front of the housing, below the borehole.
The direction of rotation of the Allen key to unlock the lid in an emergency.



Symbol on the device and in this document:
Symbol for the separate collection of electric and electronic devices according to the guideline 2002/96/EG (WEEE). The device belongs to Group 8 (medical devices).
Applies in the countries of the European Union, as well as in Norway and Switzerland.

3 Intended use

This device is a medical product (laboratory centrifuge) within the context of the IVD Directive 98/79/EC.

The centrifuge is used for centrifugal separation of human blood samples in haematocrit capillaries in accordance with EN ISO 12772 or in special manufacturer-specific capillaries for quantitative Buffy Coat Analysis.

The centrifuge is only meant for this purpose.

Another use or one which goes beyond this, is considered to be non-intended. The company Andreas Hettich GmbH & Co. KG is not liable for damage resulting from this.

Observing all information in the operating instructions and complying with the measures described therein is also a part of the intended use.

If the centrifuge is installed in another device or in a system, the manufacturer of the overall system is responsible for its safety.

4 Remaining risks

The device is built according to the state-of-the-art and the recognized safety regulations. If used and handled improperly, there could be life-threatening danger to the user or third parties, or the device could be impaired or there could be other property damage. The device is only to be used for its intended purpose and only when it is in safe working condition.

Malfunctions which could affect safety must be corrected immediately.

5 Technical specifications

Manufacturer	Andreas Hettich GmbH & Co. KG D-78532 Tuttlingen	
Model	HAEMATOKRIT 200	
Type	1801	1801-01
Mains voltage ($\pm 10\%$)	200 - 240 V 1~	100 - 127 V 1~
Mains frequency	50 - 60 Hz-	50 - 60 Hz-
Connected load	270 VA	270 VA
Current consumption	1.3 A	2.6 A
Max. capacity	24 x 2.2 ml	
Allowed density	1.2 kg/dm ³	
Speed (RPM)	13000	
Force (RCF)	16060	
Kinetic energy	950 Nm	
Obligatory inspection (BGR 500)	no	
Ambient conditions (EN / IEC 61010-1)	Indoors only Up to 2000 m above sea level 2°C to 40°C Maximum relative humidity 80% for temperatures up to 31°C, linearly decreasing to 50% relative humidity at 40°C.	
– Set-up site		
– Altitude		
– Ambient temperature		
– Humidity		
– Excess-voltage category (IEC 60364-4-443)	II	
– Pollution degree	2	
Device protection class	I	
Not suitable for use in explosion-endangered areas.		
EMC		
– Emitted interference, Interference immunity	EN / IEC 61326-1, Class B	FCC Class B
Noise level (dependent on rotor)	≤ 56 dB(A)	
Dimensions		
– Width	261 mm	
– Depth	353 mm	
– Height	228 mm	
Weight	approx. 10 kg	

6 Notes on safety



No claim of warranty will be considered by the manufacturer unless ALL instructions in this manual have been followed.



- The centrifuge should be installed on a good, stable base.
- Before using the centrifuge absolutely check the rotor for firm placement.
- When the centrifuge is running, according to EN / IEC 61010-2-020, no persons, dangerous substances or objects may be within the safety margin of 300 mm around the centrifuge.
- Rotors, suspensions and accessories that possess traces of corrosion or mechanical damage or if their term of use has expired may not be used any longer.
- The centrifuge may no longer be put into operation when the centrifuging chamber has safety-related damages.
- For centrifuges without temperature control, when the room temperature is increased and/or if the device is frequently used, the centrifuging chamber could be heated up. Therefore, it can't be ruled out that the sample material might be changed due to the temperature.

- Before the initial operation of your centrifuge you should read and pay attention to the operating instructions. Only personnel that has read and understood the operating instructions are allowed to operate the device.
- Along with the operating instructions and the legal regulations on accident prevention, you should also follow the recognised professional regulations for working in a safe and professional manner. These operating instructions should be read in conjunction with any other instructions concerning accident prevention and environmental protection based on the national regulations of the country where the device is to be used.
- This centrifuge is a state-of-the-art piece of equipment which is extremely safe to operate. However, it can lead to danger for users or others if used by untrained staff, in an inappropriate way or for a purpose other than that it was designed for.
- The centrifuge must not be moved or knocked during operation.
- In case of fault or emergency release, never touch the rotor before it has stopped turning.
- To avoid damage due to condensate, when changing from a cold to a warm room the centrifuge must either heat up for at least 3 hours in the warm room before being connected to the mains, or run hot for 30 minutes in the cold room.
- Only the rotor approved by the manufacturer for this device and the approved accessories may be used (see chapter "Anhang/Appendix, Rotoren und Zubehör/Rotors and accessories"). Before centrifuge vessels are used which are not listed in the chapter "Appendix, Rotors and accessories", the user must make sure they can be used by asking the manufacturer.
- The centrifuge rotor may only be loaded in accordance with the chapter "Loading the rotor".
- When centrifuging with maxim revolutions per minute the density of the materials or the material mixtures may not exceed 1.2 kg/dm³.
- The centrifuge may only be operated when the balance is within the bounds of acceptability.
- The centrifuge may not be operated in explosion-endangered areas.
- The centrifuge must not be used with:
 - inflammable or explosive materials
 - materials that react with one another producing a lot of energy.
- If users have to centrifuge hazardous materials or compounds contaminated with toxic, radioactive or pathogenic micro-organisms, they must take appropriate measures.
 For hazardous substances centrifuge containers with special screw caps must strictly be used. In addition to the screw cap centrifuge containers, for materials in hazard category 3 and 4 a biosafety system must be used (see the World Health Organisation's "Laboratory Biosafety Manual").
 Without the use of a biosafety system the centrifuge is not microbiologically sealed in the sense of the EN / IEC 610101-2-020 standard.
 No biosafety systems are available for this centrifuge.

- The centrifuge must not be operated with highly corrosive substances which could impair the mechanical integrity of rotors, hangers and accessories.
- Repairs must only be carried out by personnel authorised to do so by the manufacturer.
- Only original spare parts and original accessories licensed by the Andreas Hettich GmbH & Co. KG company are allowed to be utilised.
- The following safety regulations apply:
EN / IEC 61010-1 and EN / IEC 61010-2-020 as well as their national deviations.
- The safe operation and reliability of the centrifuge can only be guaranteed if:
 - the centrifuge is operated in accordance with the operating instructions,
 - the electrical installation on the site where the centrifuge is installed conforms to the demands of EN / IEC stipulations.
- Meeting the country-specific requirements concerning occupational safety with regard to the use of laboratory centrifuges at the workplaces provided for this purpose by the user is the responsibility of the user.

7 Transport and storage

7.1 Transport

 Before transporting the device, the transport securing device must be installed.

When the device and accessories are transported, the following ambient conditions must be complied with:

- Ambient temperature: -20°C to +60°C
- Relative humidity: 20% to 80%, non-condensing

7.2 Storage

 The device and the accessories may only be stored in closed and dry rooms.

When the device and accessories are stored, the following ambient conditions must be complied with:

- Ambient temperature: -20°C to +60°C
- Relative humidity: 20% to 80%, non-condensing

8 Scope of delivery

The following accessories are delivered with the centrifuge:

- 1 connecting cable
- 2 fuses
- 1 hex head wrench
- 1 operating manual
- 1 information sheet, transport securing device
- 1 information sheet, emergency unlocking

The rotor(s) and associated accessories are included in the delivery in the quantity.

9 Removing the transport securing device



It is imperative that the transport securing device be removed.

Keep the transport securing device in a safe place since it must be installed again before transporting the device.

The device may only be transported with the transport securing device installed.

To protect the device from damage during transport, the motor is fixed in place. This transport securing device must be removed when the device is put into operation.

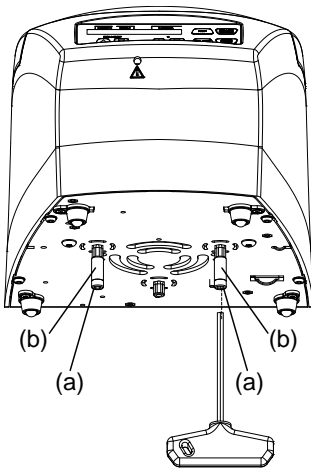

- Remove the two screws (a) and spacer sleeves (b).



The transport securing device is installed in the opposite order.

10 Initial operation

- Remove the transport securing device from the housing floor; see the "Removing the transport securing device" chapter.
- **Position the centrifuge in a stable and level manner in a suitable place. During set-up, the required safety margin of 300 mm around the centrifuge is to be kept according to EN / IEC 61010-2-020.**



When the centrifuge is running, according to EN / IEC 61010-2-020, no persons, dangerous substances or objects may be within the safety margin of 300 mm around the centrifuge.

- Ventilation openings may not be blocked. A distance of 300 mm must be maintained from the ventilation slots and openings of the centrifuge.
- Check whether the mains voltage tallies with the statement on the type plate.
- Connect the centrifuge with the power cord to a standard mains socket. For connection ratings refer to Chapter "Technical specifications".
- Switch on the mains switch (switch position "I"). The following displays appear one after the other:
 1. The centrifuge model
 2. The type number and program version
 3. The last used centrifugation data



If the lid is closed, the message "Open the lid" is displayed. In this case, open the lid to display the centrifugation data.

11 Opening and closing the lid

11.1 Opening the lid



The lid can only be opened if the centrifuge is switched on and the rotor is stationary. If this shouldn't be possible, see the "Emergency unlock" chapter.



When the cycle counter is activated, after a centrifugation run, while opening the lid, the remaining number of running cycles (centrifugation runs) is briefly displayed.

Example:

>RCF<	RPM	t/min:s
RemCycles= 16703		



- Press the key.
The lid is unlocked by the motor.
🔓 : Lid unlocked.

Example:

>RCF<	RPM	t/min:s
🔓	4500	5:00

11.2 Closing the lid



Do not reach with your fingers between the lid and housing.
Do not slam the lid closed.

- Put the lid on and lightly press the front edge of the lid down.
The lid is locked by the motor.
🔒 : Lid locked.

Example:

>RCF<	RPM	t/min:s
🔒	4500	5:00

12 Installation and removal of the rotor

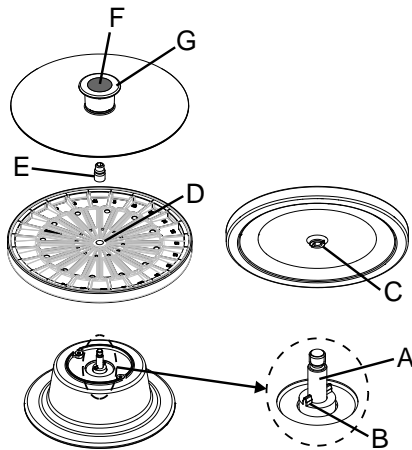

Installation:

- Place the rotor vertically onto the motor shaft (A) and press it downwards. The motor shaft dog (B) has to fit in the rotor slot (C). The alignment of the groove is labelled on the rotor (D).
- Screw the fixing nut (E) with the supplied hex. pin driver on the motor shaft (A) by turning in a clockwise direction and tighten it.



The fixing nut (E) must always be firmly tightened to the motor shaft (A).

- Check the rotor to make sure it is seated firmly.
- Put the lid onto the rotor and press it down at the handle as far as the lid clicks in.

Removal:

- Press the knob (F) in the handle of the lid downwards, simultaneously pull the outer ring (G) of the handle and remove the lid from the rotor.
- Unscrew the fixing nut (E) with the supplied hex. pin driver by turning in a counter clockwise direction, and remove it.
- Lift up the rotor from the motor shaft (A).

13 Loading the rotor

- Check the rotor for firm seating.
- Remove the cover from the rotor:
Press the button (F) in the handle of the cover downward, and at the same time, pull the outer ring (G) of the handle upward and remove the cover from the rotor. For figure, see the chapter "Installation and removal of the rotor".
- The rotor may only be loaded symmetrically. The centrifuge containers have to be distributed evenly on all rotor positions. For authorised combinations see Chapter "Anhang/Appendix, Rotoren und Zubehör/Rotors and accessories".

Example:

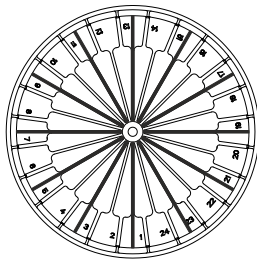

Rotor is evenly loaded

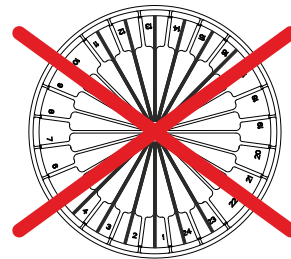

Not permitted!

Rotor is not evenly loaded

- For the haematocrit measurement the capillaries are always filled up to $\approx 75\%$.
- When loading the rotor, no liquid may enter the rotor or the centrifuging chamber.
- When using standard capillary tubes, insert these in the rotor with the lute side out.
When using self-sealing capillary tubes, insert these in the rotor with the plug side out.
- After loading the rotor, place the cover on the rotor and press downward on the handle until the cover engages.

14 Operating and display elements

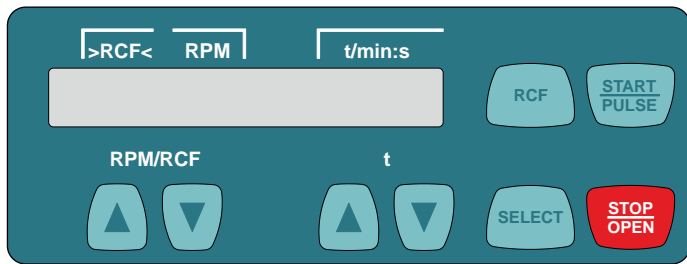

14.1 Displayed symbols



Lid unlocked.



Lid locked.



Rotation display. The rotation display lights up, rotating counterclockwise, as long as the rotor is turning.

14.2 Control panel keys

RPM/RCF



- Input the speed directly.
- If the key is kept pressed, the value changes with increasing speed.

t



- Input the runtime directly.
- Adjustable in steps of 1 second up to a minute, and in steps of 1 minute starting from 1 minute.
- Input the centrifuging parameters.
- If the key is kept pressed, the value changes with increasing speed.



- Selection key for activating the individual parameters. Every time the key is pressed, the next parameter is activated.
- Call up the "MACHINE MENU" (keep the key pressed for 8 seconds).
- In the "Machine Menu", select the menus "-> Info", "-> Settings" and "-> Time & Cycles".
- Scroll forward in the menus.



- Switching between the RPM display (RPM) and RCF display (>RCF<). RCF values are displayed in parentheses ><.
- RPM Speed
- RCF : Relative centrifugal acceleration



- Start the centrifugation run.
- Short-term centrifugation. Centrifugation is run as long as the key is kept pressed.
- Call up the menus "-> Info", "-> Settings" and "-> Time & Cycles".



- Finish the centrifugation run. The rotor runs down with a pre-selected brake stage. Pressing the key twice triggers the Emergency Stop.
- Unlock the lid.

14.3 Setting options

t/min Runtime. Adjustable from 1 - 99 min, in steps of 1 minute.

t/sec Runtime. Adjustable from 1 - 59 s, in steps of 1 second.

Continuous run "--:--". Set the parameters **t/min** and **t/sec** to zero.

RPM Speed

A number value from 200 rpm to the maximum speed of the rotor can be set. Adjustable from 200 RPM to 10000 RPM in steps of 10, and above 10000 RPM, in steps of 100. For the maximum rotor speed, see the chapter "Appendix, Rotors and accessories".

>RCF< Relative centrifugal force

A number value can be set which results in a speed between 200 rpm and the maximum rotor speed. Adjustable up to 10000 in steps of 1, and above 10000, in steps of 10.



It is only possible to input the relative centrifugal force (RCF) if the RCF display (>RCF<) is activated.

The relative centrifugal force (RCF) depends on the centrifuging radius (RAD). After entering the RCF, check to make sure that the correct centrifuging radius has been set.

RAD/mm Centrifuging radius

Adjustable from 10 mm to 250 mm, in steps of 1 mm. For the centrifuging radius, see the chapter "Appendix, Rotors and accessories".







It is only possible to input the centrifuging radius if the RCF display (>RCF<) is activated.

~_DEC Brake stage. fast = short run-out time, slow = long run-out time.

15 Entering centrifugation parameters

15.1 Direct input of the centrifugation parameters

The speed (RPM), the relative centrifugal force (RCF), the centrifuging radius (RAD) and the runtime can be input directly with the keys   without previously having to press the  key.

 The set centrifugation parameters are only stored after starting the centrifugation run.

15.1.1 Speed (RPM)

Example:



- Press the key to activate the RPM display (RPM) as needed.



RPM/RCF



- Set the desired value with the keys.

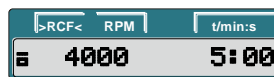

15.1.2 Relative centrifugal force (RCF) and centrifugal radius (RAD)

Example:



- Press the key to activate the RCF display (>RCF<) as needed.

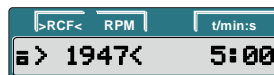

RPM/RCF



- Set the desired RCF value with the keys.

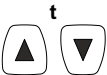

- Set the desired centrifuging radius with the keys as needed.



15.1.3 Runtime

 Up to 1 minute, the runtime can be set in steps of 1 second, and starting from 1 minute, it can only be set in steps of 1 minute.

In order to set the continuous run, the parameters **t/min** and **t/sec** must be set to zero. In the time display (t/min:s), "--:--" appears.

Example:

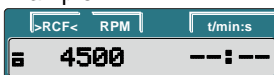

Example:



- Set the desired value with the keys.

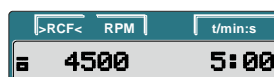

15.2 Input of the centrifugation parameters with the "SELECT" key

 The runtime can be set in minutes and seconds (parameters **t/min** and **t/sec**). In order to set the continuous run, the parameters **t/min** and **t/sec** must be set to zero. In the time display (t/min:s), "--:--" appears.

Example:















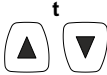

The relative centrifugal acceleration (RCF) depends on the centrifuging radius (RAD). During the input of the RCF, the set centrifuging radius is displayed.

If no key is pressed for 8 seconds after selection or during parameter input, the previous values are shown on the display. The parameters must then be input again.

By pressing the  button, the settings will be saved.

If several parameters are input, the  key must be pressed after setting the last parameter.

Entering parameters can be cancelled at any time by pressing the  key. In this case, the settings are not stored.

 ↓  ↓  ↓  ↓  ↓	<ul style="list-style-type: none"> • Press the key to activate the RPM display (RPM) or the RCF display (>RCF<) as needed. • Press the key. t/min : Runtime, minutes. • Set the desired value with the keys. • Press the key. t/sec : Runtime, seconds. • Set the desired value with the keys. 	<p>Example: RPM display (RPM)</p>     	<p>Example: RCF display (>RCF<)</p>     
--	---	---	--

Continued on next page



- Press the key.
RPM : Speed.
RAD/mm : Centrifuging radius.
 It is only possible to display and input the centrifuging radius if the RCF display (>RCF<) is activated.

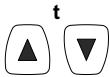

- Set the desired value with the keys.



- Press the key.
R : Centrifuging radius.
RCF : Relative centrifugal force



- Set the desired value with the keys.



- Press the key.
_DEC : Brake stage.
fast : short run-out time.
slow : long run-out time.



- Set the desired value with the keys.



- Press the button to save the settings.

**Example:
RPM display (RPM)**

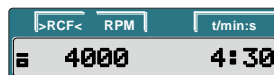
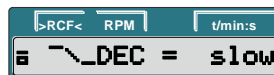

**Example:
RCF display (>RCF<)**

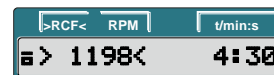

16 Centrifugation

 In accordance with EN / IEC 61010-2-020, no persons, hazardous substances or objects may be within a safety range 300 mm around the centrifuge during a centrifugation run.

 If the permissible weight difference was exceeded within the rotor load, the centrifugation run is aborted during start-up and the following will appear on the display:



A centrifugation run can be aborted at any time by pressing the  key.

During a centrifugation run, centrifugation parameters can be selected and changed. The changed values, however, only apply to the current centrifugation run and are not saved.

With the  key, you can toggle between the RPM display (RPM) and RCF display (>RCF<) at any time. If the RCF display (>RCF<) is worked with, the centrifuging radius must be input.

The following is displayed:



Further operation of the centrifuge is then only possible after opening the lid.

Operation errors and malfunctions will be shown (see the chapter on "Malfunctions").

- Switch on the mains switch. Switch position I.
- Load the rotor and close the centrifuge lid.

16.1 Centrifugation with preset time

- Press the  key to activate the RPM display (RPM) or the RCF display (>RCF<) as needed.





- Enter the desired centrifugation parameters (see the chapter "Entering centrifugation parameters").



- Press the  key to start the centrifugation run.
During the centrifugation run, the rotor speed or the resulting RCF value and remaining time are displayed.



- After the time elapses or if the centrifugation run is aborted by pressing the  key, the run-out occurs with the set brake stage. The brake stage is displayed. Example 

Example:
RPM display (RPM)

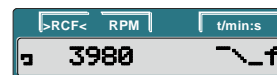

Example:
RCF display (>RCF<)

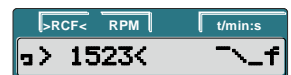
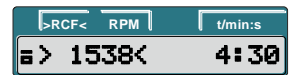

16.2 Continuous run



- Press the key to activate the RPM display (RPM) or the RCF display (>RCF<) as needed.



- Input the desired centrifugation parameters. Set the parameters **t/min** and **t/sec** to zero (see the chapter "Entering centrifugation parameters").



- Press the key to start the centrifugation run.
During the centrifugation run, the rotor speed or the resulting RCF value and elapsed time are displayed.



- Press the key to end the centrifugation run.
The run-out occurs with the set brake stage. The brake stage is displayed. Example \sim_f

Example:
RPM display (RPM)



Example:
RCF display (>RCF<)

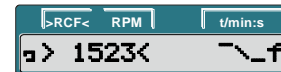
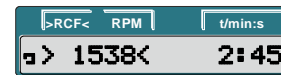
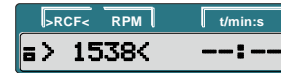

16.3 Short-term centrifugation



- Press the key to activate the RPM display (RPM) or the RCF display (>RCF<) as needed.



- Enter the desired centrifugation parameters (see the chapter "Entering centrifugation parameters").



- Press the key and keep it pressed.
During the centrifugation run, the rotor speed or the resulting RCF value and elapsed time are displayed.



- Release the key again to end the centrifugation run.
The run-out occurs with the set brake stage. The brake stage is displayed. Example \sim_f .

Example:
RPM display (RPM)

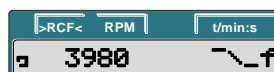
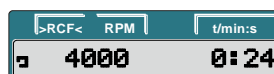
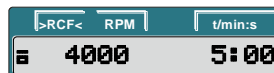

Example:
RCF display (>RCF<)

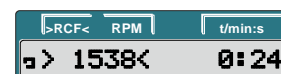
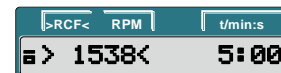
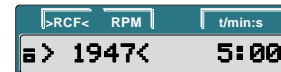

17 Emergency Stop



- Press the key twice.
During the Emergency Stop, the run-out occurs with the "fast" brake stage (short run-out time). Brake stage `~_f` is displayed.

**Example:
RPM display (RPM)**



**Example:
RCF display (>RCF<)**



18 Settings and queries

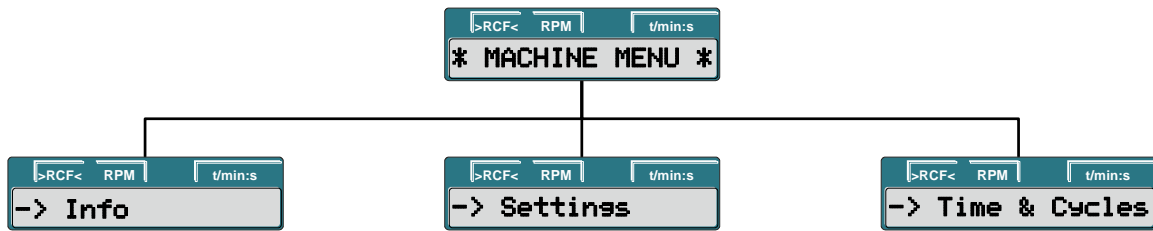

Query:

- System information

Setting:

- Acoustic signal
- Automatic unlocking of the lid after the centrifugation run
- Automatic switch-off of the background lighting
- Optical signal after ending the centrifugation run

Query:



- Hours of operation
- Number of completed centrifugation runs

18.1 Querying system information

The following system information can be queried:

- Device model,
- Program version of the device,
- Type number of the device,
- Device date of manufacture,
- Device serial number,
- Frequency converter type
- Frequency converter program version

With the rotor at a standstill, the query can proceed as follows:

 The procedure can be aborted at any time by pressing the  key.



- Press and hold the button for eight seconds.



- Press the key.



- Press the key. Device model.



- Press the key. Program version of the device.

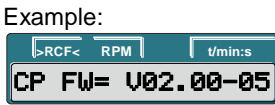

- Press the key. **Type#1** : Type number of the device.

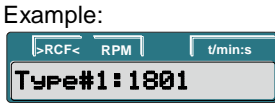

- Press the key. **Type#2** : Continuation of the type number if this has more positions than the "Type#1" display field.

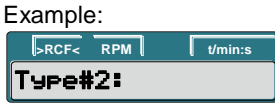

- Press the key. Device date of manufacture.

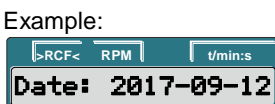

Continued on next page



- Press the key.
Device serial number.

Example:



- Press the key.
Frequency converter type.

Example:



- Press the key.
Frequency converter program version.

Example:



- Press the key twice to exit the "-> Info" menu or press three times to exit the "* MACHINE MENU *".

Example:





18.2 Acoustic signal

The acoustic signal sounds:

- after a malfunction occurs in a 2-second interval.
- after ending the centrifugation run and the rotor is at a standstill in a 30-second interval.





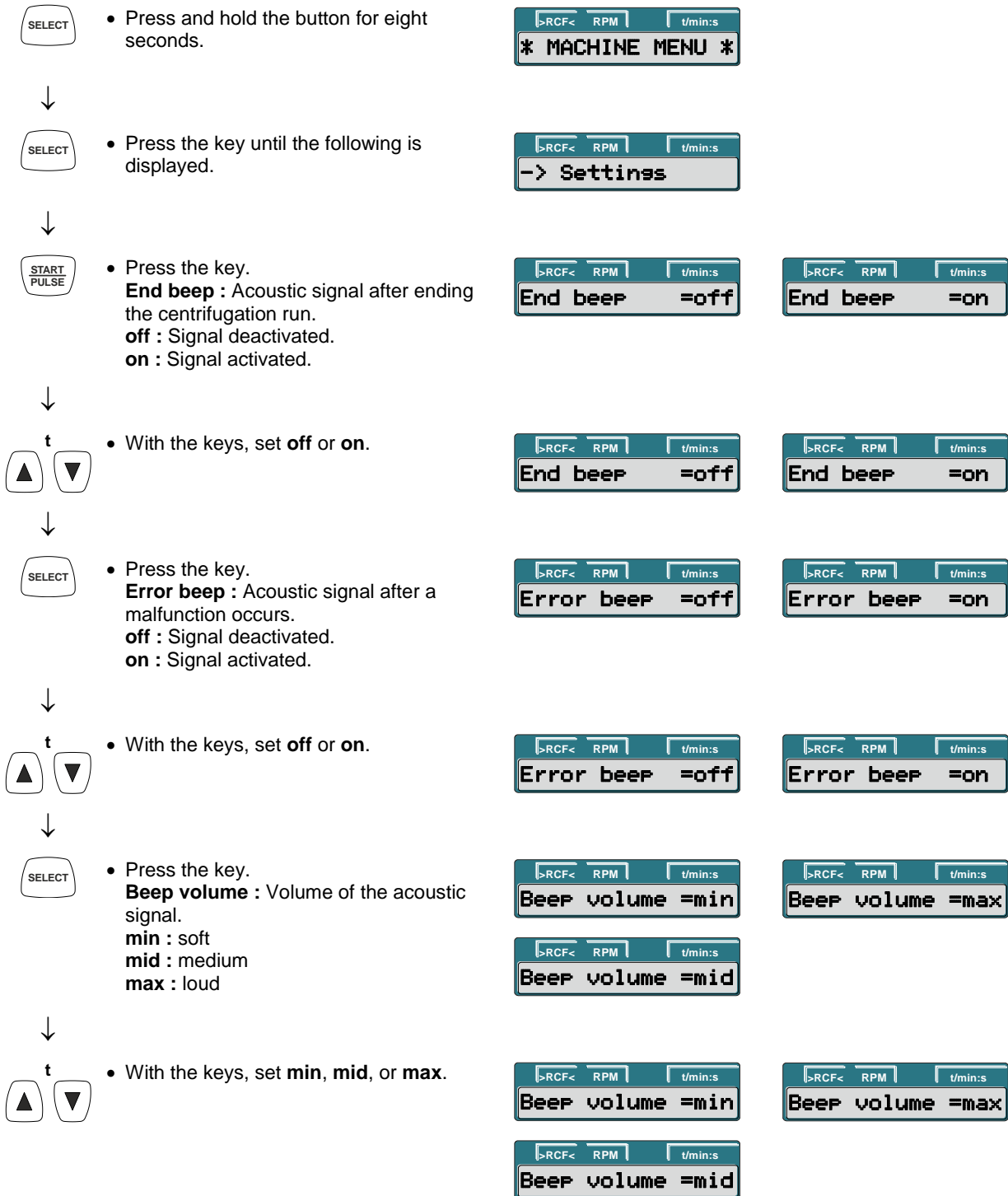

The acoustic signal is ended by pressing any key.

If the rotor is at a standstill, the acoustic signal can be set as follows:

 The procedure can be aborted at any time by pressing the  key. In this case, the settings are not stored.





Continued on next page

















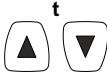

	<ul style="list-style-type: none"> • Press the button to save the setting. 		
↓			
	<ul style="list-style-type: none"> • Press the key once to exit the "-> Settings" menu or press twice to exit the "* MACHINE MENU *". 		<p>Example:</p> 

18.3 Optical signal after ending the centrifugation run

The backlighting of the display flashes after the centrifugation run to visually signalize that the centrifugation run has finished.



The optical signal can be switched on or off when the rotor is at a standstill:

















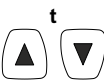

 The procedure can be aborted at any time by pressing the  key.

	<ul style="list-style-type: none"> • Press and hold the button for eight seconds. 		
↓			
	<ul style="list-style-type: none"> • Press the key until the following is displayed. 		
↓			
	<ul style="list-style-type: none"> • Press the key. 		
↓			
	<ul style="list-style-type: none"> • Press the key until one of the following is displayed: End blinking : Backlighting of display flashes after the centrifugation run. off : Backlighting does not flash. on : Backlighting flashes. 		
↓			
	<ul style="list-style-type: none"> • With the keys, set off or on. 		
↓			
	<ul style="list-style-type: none"> • Press the button to save the setting. 		
↓			
	<ul style="list-style-type: none"> • Press the key once to exit the "-> Settings" menu or press twice to exit the "* MACHINE MENU *". 		<p>Example:</p> 

18.4 Automatic unlocking of the lid after the centrifugation run

It can be set whether the lid should automatically unlock or not after the centrifugation run. With the rotor at a standstill, this can be set as follows:



 The procedure can be aborted at any time by pressing the  key. In this case, the settings are not stored.

















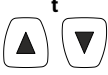

	<ul style="list-style-type: none"> Press and hold the button for eight seconds. 		
↓			
	<ul style="list-style-type: none"> Press the key until the following is displayed. 		
↓			
	<ul style="list-style-type: none"> Press the key. 		
↓			
	<ul style="list-style-type: none"> Press the key until one of the following is displayed: Lid AutoOpen : Automatic unlocking of the lid after the centrifugation run. off : Lid does not unlock automatically. on : Lid unlocks automatically. 		
↓			
	<ul style="list-style-type: none"> With the keys, set off or on. 		
↓			
	<ul style="list-style-type: none"> Press the button to save the setting. 		
↓			
	<ul style="list-style-type: none"> Press the key once to exit the "-> Settings" menu or press twice to exit the "* MACHINE MENU *". 		<p>Example:</p> 

18.5 Backlighting of the display

To save energy, it can be set that, after a centrifugation run, the backlighting of the display switches off after 2 minutes.

With the rotor at a standstill, this can be set as follows:

 The procedure can be aborted at any time by pressing the  key. In this case, the settings are not stored.

	<ul style="list-style-type: none"> Press and hold the button for eight seconds. 		
↓			
	<ul style="list-style-type: none"> Press the key until the following is displayed. 		
↓			
	<ul style="list-style-type: none"> Press the key. 		
↓			
	<ul style="list-style-type: none"> Press the key until one of the following is displayed: Power save : Automatic shutdown of the backlighting. off : Automatic shutdown deactivated. on : Automatic shutdown activated. 		
↓			
	<ul style="list-style-type: none"> With the keys, set off or on. 		
↓			
	<ul style="list-style-type: none"> Press the button to save the setting. 		
↓			
	<ul style="list-style-type: none"> Press the key once to exit the "-> Settings" menu or press twice to exit the "* MACHINE MENU *". 		<p>Example:</p> 



18.6 Querying the hours of operation and the number of centrifugation runs

The hours of operation are divided into internal and external hours of operation.

Internal hours of operation: Total time the device was switched on.

External hours of operation: Total time of the previous centrifugation runs.

With the rotor at a standstill, the query can proceed as follows:

 The procedure can be aborted at any time by pressing the  key.



- Press and hold the button for eight seconds.



- Press the key until the following is displayed.



- Press the key.
TimeExt : External hours of operation.

Example:



- Press the key.
TimeInt : Internal hours of operation.

Example:



- Press the key.
Starts : Number of all centrifugation runs.

Example:



- Press the key twice to exit the "-> Time & Cycles" menu or press three times to exit the "* MACHINE MENU *".



Example:

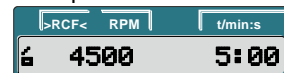

19 Relative centrifugal force (RCF)

The relative centrifugal force (RCF) is given as a multiple of the acceleration of gravity (g). It is a unit-free value and serves to compare the separation and sedimentation performance.

These values are calculated using the formula below:

$$\text{RCF} = \left(\frac{\text{RPM}}{1000} \right)^2 \times r \times 1,118 \quad \Rightarrow \quad \text{RPM} = \sqrt{\frac{\text{RCF}}{r \times 1,118}} \times 1000$$

RCF = relative centrifugal force

RPM = rotational speed (revolutions per minute)

r = centrifugal radius in mm = distance from the centre of the turning axis to the bottom of the centrifuge container. For more on the centrifugal radius see the chapter "Anhang/Appendix, Rotoren und Zubehör/Rotors and accessories".



The relative centrifugal force (RCF) stands in relation to the revolutions per minute and the centrifugal radius.

20 Centrifugation of materials or mixtures of materials with a density higher than 1.2 kg/dm³

When centrifuging with maximum revolutions per minute the density of the materials or the material mixtures may not exceed 1.2 kg/dm³.

The speed must be reduced for materials or mixtures of materials with a higher density.

The permissible speed can be calculated using the following formula:

$$\text{Reduced speed (n}_{\text{red}}) = \sqrt{\frac{1.2}{\text{Greater density [kg/dm}^3]}} \times \text{maximum speed [RPM]}$$

e.g.: maximum speed RPM 4000, density 1.6 kg/dm³

$$n_{\text{red}} = \sqrt{\frac{1.2 \text{ kg/dm}^3}{1.6 \text{ kg/dm}^3}} \times 4000 \text{ RPM} = 3464 \text{ RPM}$$

If in doubt you should obtain clarification from the manufacturer.

21 Haematocrit measurement

21.1 Determining the centrifugation time

To determine the centrifugation time, the following approximation formula applies:

$$\frac{100000}{\text{RCF}} = \text{centrifugation time in minutes}$$

RCF = Relative centrifugal acceleration

To calculate the RCF, see the chapter "Relative centrifugal acceleration (RCF)".

Example:

RCF = 16060

$$\frac{100000}{16060} = 6.23 \text{ minutes} = 6 \text{ minutes and } 14 \text{ seconds}$$

For a RCF of 16060, the centrifugation time is 6 minutes and 14 seconds.

21.2 Reading off the hematocrit value

The hematocrit value is read off as follows:

- Hold onto the rotor.
- Turn the evaluation disk (rotor cover) until the 100% line of the evaluation disk is aligned with the top edge of the fluid column in the capillary tube.
- Read off the hematocrit value at the top edge of the erythrocyte column.

Repeat this procedure until all capillary tubes have been evaluated.

22 Emergency unlocking

In the event of a power failure, the lid cannot be unlocked with the motor. Emergency unlocking must be done by hand.



To unlock in an emergency, disconnect the centrifuge from the mains.
Open the lid only when the rotor is at a standstill.



CAUTION! Damage to the lock during emergency unlocking by turning the hexagon Allen key in clockwise direction (to the right).

The Allen key may only be turned counter clockwise (to the left); see figure.

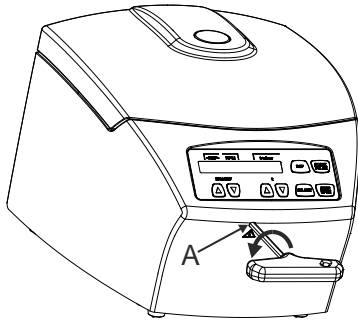

- Switch off the mains switch (switch setting "0").
- Look through the window in the lid to make sure that the rotor is at a standstill.
- Insert the Allen key horizontally in the bore (A) and turn carefully counter clockwise (to the left) until the lid opens.
- Pull the Allen key back out of the bore.

23 Maintenance and servicing



The device can be contaminated.



Pull the mains plug before cleaning.

Before any other cleaning or decontamination process other than that recommended by the manufacturer is applied, the user has to check with the manufacturer that the planned process does not damage the device.

- Centrifuges, rotors and accessories must not be cleaned in rinsing machines.
- They may only be cleaned by hand and disinfected with liquids.
- The water temperature must be between 20 – 25°C.
- Only detergents/disinfectants may be used which:
 - have a pH between 5 - 8
 - do not contain caustic alkalis, peroxides, chlorine compounds, acids and alkaline solutions
- In order to prevent appearances of corrosion through cleaning agents or disinfectants, the application guide from the manufacturer of the cleaning agent or disinfectant are absolutely to be heeded.



Haematocrit rotor, rotor lid, padded shells, and sealing rings are not autoclavable.

23.1 Centrifuge (housing, lid and centrifuging chamber)

23.1.1 Surface cleaning and care

- Clean the centrifuge housing and the centrifuging chamber regularly, using soap or a mild detergent and a damp cloth if required. For one thing, this services purposes of hygiene, and it also prevents corrosion through adhering impurities.
- Ingredients of suitable detergents:
soap, anionic tensides, non-ionic tensides.
- After using detergents, remove the detergent residue by wiping with a damp cloth.
- The surfaces must be dried immediately after cleaning.
- In the event of condensation water formation, dry the centrifugal chamber by wiping out with an absorbent cloth.
- Lightly rub the rubber seal of the centrifuge chamber with talcum powder or a rubber care product after each cleaning.
- The centrifuging chamber is to be checked for damage once a year.



If damage is found which is relevant to safety, the centrifuge may no longer be put into operation. In this case, notify Customer Service.

23.1.2 Surface disinfection

- If infectious materials penetrates into the centrifugal chamber this is to be disinfected immediately.
- Ingredients of suitable disinfectants:
ethanol, n-propanol, ethyl hexanol, anionic tensides, corrosion inhibitors.
- After using disinfectants, remove the disinfectant residue by wiping with a damp cloth.
- The surfaces must be dried immediately after disinfecting.

23.1.3 Removal of radioactive contaminants

- The agent must be specifically labelled as being an agent for removing radioactive contaminants.
- Ingredients of suitable agents for removing radioactive contaminants:
anionic tensides, non-ionic tensides, polyhydrated ethanol.
- After removing the radioactive contaminants, remove the agent residue by wiping with a damp cloth.
- The surfaces must be dried directly after removing the radioactive contaminants.

23.2 Cleaning and disinfecting the haematocrit rotor

If despite all precautions a leakage of haematocrit capillaries during centrifugation should occur, rotor and lid must be cleaned according to the following instructions:

- Carefully remove padded shells or sealing ring from the haematocrit rotor.
- Soak haematocrit rotor, lid and padded shells or sealing ring in cold water, until the blood residues are completely dissolved.
- Perform a suitable disinfection. The application of disinfection substances on the lid is to be avoided as the inscription can dissolve.
Ingredients of suitable disinfectants: glutaraldehyde, propanol, ethyl hexanol, anionic tensides, corrosion inhibitors.
Ingredients of suitable agents for removing radioactive contaminants: anionic tensides, non-ionic tensides, polyhydrated ethanol.
- Rinse the components in cold water and dry them.
- They can now be replaced into the centrifuge.

23.3 Procedure in case of broken haematocrit capillaries



Risk of injury!

Best work with two pairs of gloves worn on top of each other. Wear safety goggles and mask, as glass splinters could be blown off!

- Carefully remove lid of haematocrit rotor.
- Remove larger pieces of broken capillaries using pincers.
- Remove rotor. Carefully and slowly remove the affected padded shells or the sealing ring with pincers and exchange them.
- Clean and disinfect as described above.

23.3.1 Rotors and accessories with limited service lives

The rotor (order no. 2076) can only be used for a limited time.

The expiration date can be seen on the rotor, e.g.: "einsetzbar bis Ende: IV. Quartal 2019 / usable until end of: IV. Quartal 2019" (4th quarter 2019).







For safety reasons, the rotor may no longer be used once the expiration date marked on it has been reached.

24 Faults

If the fault cannot be eliminated with the help of the fault table, please inform Customer Service.

Please specify the type of centrifuge and the serial number. Both numbers can be found on the name plate of the centrifuge.

	<p>Perform a MAINS RESET:</p> <ul style="list-style-type: none"> – Switch off the mains switch (switch position "0"). – Wait at least 10 seconds and then switch on the mains switch again (switch position "I").
---	---

Message / fault		Cause	Remedy
No display		No voltage Mains input fuses defective.	<ul style="list-style-type: none"> – Check distribution voltage. – Check mains power input fuse, refer to Chapter "Change mains input fuse". – Mains switch ON.
IMBALANCE		The rotor is unevenly loaded.	<ul style="list-style-type: none"> – Open the lid after the rotor is at a standstill. – Check the loading of the rotor, see chapter "Loading the rotor". – Repeat the centrifugation run.
MAINS INTER	11	Power failure during the centrifugation run. (The centrifugation run was not finished.)	<ul style="list-style-type: none"> – Open the lid after the rotor is at a standstill. – Push  button. – Repeat the centrifugation run if necessary.
MAINS INTERRUPT			
TACHO ERROR	1, 2	Failure of speed impulses during operation.	<ul style="list-style-type: none"> – Perform a MAINS RESET when the rotor has been stationary.
LID ERROR	4.1 – 4.127	Error in lid locking or lid closure.	
OVER SPEED	5	Rotation too fast	
VERSION ERROR	12	Incorrect centrifuge model recognized. Error / defect electronics	
UNDER SPEED	13	Rotation too slow	
CTRL ERROR	22.1, 25.2	Error / defect electronics	<ul style="list-style-type: none"> – The device may not be switched off as long as the rotation display  is lit up and rotating. Wait until the symbol  (lid locked) is displayed (after approx. 120 seconds). Afterwards, carry out a MAINS RESET.
CRC ERROR	27.1		
COM ERROR	31 – 36		
FC ERROR	60, 61.1 – 61.21, 61.64 – 61.142		
FC ERROR	61.23		
TACHO ERR	61.22	Speed measurement error	
FC ERROR	61.153	Error / defect electronics	<ul style="list-style-type: none"> – Perform a MAINS RESET. – Check the loading of the rotor, see chapter "Loading the rotor". – Repeat the centrifugation run.

25 Change mains input fuses



Switch off the mains switch and separate the device from the mains!

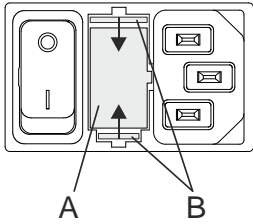

The fuse holder (A) with the mains input fuses is located next to the mains switch.

- Remove the connecting cable from the machine plug socket.
- Press the snap-fit (B) against the fuse holder (A) and remove.
- Exchange defective mains input fuses.



Only use fuses with the rating defined for the type. See the following table.

- Reinsert the fuse holder until the snap-fit clicks shut.
- Reconnect the device to the mains supply.

Model	Type	Fuse	Order no.
HAEMATOKRIT 200	1801	T 3,15 AH/250V	E997
HAEMATOKRIT 200	1801-01	T 6,3 AH/250V	2266

26 Returning Devices



Before returning the device, a transport securing device has to be installed.

If the device or its accessories are returned to Andreas Hettich GmbH & Co. KG, in order to provide protection for people, the environment and materials, it has to be decontaminated and cleaned before being shipped.

We reserve the right to refuse contaminated devices or accessories.

Costs incurred for cleaning and disinfection are to be charged to the customer.

We ask for your understanding in this matter.

27 Disposal

Before disposal, the device must be decontaminated and cleaned to protect people, the environment and property.

When you are disposing of the device, the respective statutory rules must be observed.

Pursuant to guideline 2002/96/EC (WEEE), all devices supplied after August 13, 2005 may not be disposed as part of domestic waste. The device belongs to group 8 (medical devices) and is categorized in the business-to-business field.



The icon of the crossed-out trash can shows that the device may not be disposed as part of domestic waste.

The waste disposal guidelines of the individual EC countries might vary. If necessary, contact your supplier.

Table des matières

1	Utilisation de ce mode d'emploi	71
2	Signification des symboles.....	71
3	Utilisation conforme	71
4	Risques résiduels	71
5	Données techniques	72
6	Consignes de sécurité	73
7	Transport et stockage	74
7.1	Transport	74
7.2	Stockage.....	74
8	Etendue de la livraison.....	74
9	Retirer les dispositifs de sécurité pour le transport	75
10	Mise en service	75
11	Ouvrir et fermer le couvercle	76
11.1	Ouvrir le couvercle	76
11.2	Fermer le couvercle	76
12	Montage et démontage du rotor	77
13	Chargement du rotor	77
14	Éléments de commande et d'affichage.....	78
14.1	Pictogrammes	78
14.2	Touches du champ de commande	78
14.3	Réglages possibles	79
15	Saisir les paramètres de centrifugation	80
15.1	Saisie directe des paramètres de centrifugation	80
15.1.1	Vitesse de rotation (RPM)	80
15.1.2	Accélération centrifuge relative (RCF) et rayon de centrifugation (RAD)	80
15.1.3	Durée de fonctionnement.....	80
15.2	Saisie des paramètres de centrifugation avec la touche "SELECT"	81
16	Centrifugation	83
16.1	Centrifugation avec présélection temps	83
16.2	Fonctionnement continu.....	84
16.3	Cycle de centrifugation court.....	84
17	Arrêt d'urgence	85
18	Réglages et demandes	85
18.1	Demander des informations sur le système	86
18.2	Signal sonore	88
18.3	Signal optique à la fin du cycle de centrifugation	89
18.4	Déverrouillage automatique du couvercle après le cycle de centrifugation.....	90
18.5	Eclairage d'arrière-plan de l'affichage	91
18.6	Demander les heures de fonctionnement et le nombre de cycles de centrifugation	92
19	Accélération centrifuge relative (RCF).....	93
20	Centrifugation de matières et de mélanges d'une densité supérieure à 1,2 kg/dm ³	93
21	Détermination de l'hématocrite	93
21.1	Déterminer le temps de centrifugation	93

21.2	Lire la valeur hématoците.....	93
22	Déverrouillage de secours.....	94
23	Entretien et maintenance	94
23.1	Centrifugeuse (boîtier, couvercle et cuve)	95
23.1.1	Entretien et nettoyage des surfaces	95
23.1.2	Désinfection des surfaces.....	95
23.1.3	Décontamination de substances radioactives.....	95
23.2	Nettoyage et désinfection du disque de centrifugation.....	95
23.3	Manière de procéder en cas de capillaires brisés.....	96
23.3.1	Rotors et accessoires à durée d'utilisation limitée	96
24	Défauts.....	97
25	Changer les fusibles d'entrée de secteur	98
26	Renvoi d'appareils au fabricant	98
27	Élimination des déchets	98
28	Anhang / Appendix.....	130
28.1	Rotoren und Zubehör / Rotors and accessories.....	130

1 Utilisation de ce mode d'emploi

- Lisez et respectez impérativement les consignes et indications contenues dans le mode d'emploi avant d'utiliser la centrifugeuse.
- Le mode d'emploi fait partie intégrante de l'appareil. Vous devez le conserver de manière à toujours être à portée de main.
- Si vous changez l'appareil de place, le mode d'emploi doit suivre l'appareil.

2 Signification des symboles



Symbole sur l'appareil :
Attention, zone de danger général.



Symbole sur l'appareil :
respecter le mode d'emploi.
Ce symbole indique que l'utilisateur doit respecter le mode d'emploi mis à disposition.



Symbole dans ce document:
Attention, zone de danger général.
Ce symbole indique des consignes de sécurité et signale des situations pouvant être sources de danger. Le non-respect de ces instructions peut entraîner des dégâts matériels et personnels.



Symbole sur l'appareil et dans ce document:
Avertissement de menace biologique pour l'environnement.



Symbole dans ce document:
Ce symbole signale des informations importantes.



Symbole sur l'appareil :
Le symbole se trouve sur le boîtier, à proximité de la charnière.
Sens de rotation du rotor.



Symbole sur l'appareil :
Le symbole se trouve sur le devant du boîtier, sous l'ouverture.
Sens de rotation de la clé hexagonale pour le déverrouillage d'urgence du couvercle.



Symbole sur l'appareil et dans ce document:
Symbole pour la collecte séparée des appareils électriques et électroniques, conformément à la directive 2002/96(EG (WEEE). L'appareil fait partie du groupe 8 (appareils de médecine).
Utilisation dans les pays de l'Union Européenne ainsi qu'en Norvège et en Suisse.

3 Utilisation conforme

L'appareil dont il est question est un produit médical (centrifugeuse de laboratoire) dans l'esprit de la directive IVD 98/79/CE.

La centrifugeuse sert à la centrifugation de prélèvements sanguins d'origine humaine dans des capillaires hématocrites conformément à la Norme Européenne ISO 12772 ou dans des capillaires spéciaux spécifiques au fabricant pour l'analyse quantitative Buffy Coat.

La centrifugeuse est exclusivement destinée à cette plage d'utilisation.

Toute utilisation en dehors ou au delà de ce cadre est considérée comme non conforme. L'entreprise Andreas Hettich GmbH & Co. KG décline toute responsabilité pour tout dommage en résultant.

L'utilisation conforme comprend également le respect de toutes les indications contenues dans le mode d'emploi et des travaux d'inspection et d'entretien.

Si la centrifugeuse est montée dans un autre appareil ou intégrée dans un système, c'est le fabricant du système complet qui est responsable de sa sécurité.

4 Risques résiduels

L'appareil est construit conformément au niveau actuel de la technologie et des règles de sécurité éprouvées. L'utilisation et la manipulation non conforme de cet appareil risquent de menacer la santé et l'intégrité corporelle de l'utilisateur ou de tierces personnes, ou de détériorer l'appareil ou autres biens matériels. Utilisez exclusivement

l'appareil conformément à l'usage pour lequel il a été conçu et uniquement s'il est dans un état de fonctionnement technique irréprochable.

Remédier sans attendre à tout dérangement susceptible de porter atteinte à la sécurité.

5 Données techniques

Fabricant	Andreas Hettich GmbH & Co. KG D-78532 Tuttlingen	
Modèle	HAEMATOKRIT 200	
Type	1801	1801-01
Tension du réseau ($\pm 10\%$)	200 - 240 V 1~	100 - 127 V 1~
Fréquence du réseau	50 - 60 Hz-	50 - 60 Hz
Charge de connexion	270 VA	270 VA
Consommation de courant	1.3 A	2.6 A
Capacité max.	24 x 2.2 ml	
Densité admise	1.2 kg/dm ³	
Vitesse de rotation (RPM)	13000	
Accélération (RCF)	16060	
Energie cinétique	950 Nm	
Obligation de contrôle (BGR 500)	non	
Conditions ambiantes (EN / IEC 61010-1)	uniquement dans les intérieurs	
– Emplacement	Jusqu'à 2000 m au dessus du niveau de la mer	
– Hauteur	2°C à 40°C	
– Température ambiante	humidité de l'air max. relative 80% pour températures jusqu'à 31°C, décroissant en linéaire jusqu'à 50% de l'humidité relative pour 40°C.	
– Humidité de l'air	II	
– Catégorie de surtension (IEC 60364-4-443)	2	
– Degré d'encrassement	I	
Catégorie de protection de l'appareil	I	
Non approprié pour l'usage dans un environnement exposé aux explosions.		
EMV	EN / IEC 61326-1, catégorie B	
– Emission de parasites, Résistance aux interférences	FCC Class B	
Niveau du bruit (en fonction du rotor)	≤ 56 dB(A)	
Dimensions		
– Largeur	261 mm	
– Profondeur	353 mm	
– Hauteur	228 mm	
Poids	env. 10 kg	

6 Consignes de sécurité



Aucune demande garantie ne pourra être revendiquée auprès du fabricant si les indications données dans ce mode d'emploi ne sont pas toutes respectées.



- **Veiller à la stabilité de la centrifugeuse.**
- **Avant d'utiliser la centrifugeuse, il est indispensable de vérifier la fixation correcte du rotor.**
- **Durant un processus de centrifugation, aucune personne, matière dangereuse et aucun objet ne doivent se trouver dans une zone de sécurité de 300 mm autour de la centrifugeuse selon EN / IEC 61010-2-020.**
- **Les rotors, balanciers et accessoires qui présentent d'importantes traces de corrosion ou des défauts mécaniques ou dont la durée d'utilisation a expiré ne doivent plus être utilisés.**
- **Suspendre immédiatement l'utilisation de la centrifugeuse si la cuve de centrifugeuse présente des dommages susceptibles de porter atteinte à la sécurité.**
- **Concernant les centrifugeuses sans réglage de température, il peut y avoir un réchauffement dans la cuve de centrifugeuse en cas de température ambiante élevée et/ou d'utilisation fréquente de l'appareil. Il n'est donc pas possible d'exclure une modification de l'échantillon due à la température.**

- **Il importe de lire et de respecter le mode d'emploi avant la mise en service de la centrifugeuse. Seules les personnes ayant lu et compris le mode d'emploi sont autorisées à manipuler l'appareil.**
- Outre le mode d'emploi et les réglementations contraignantes relatives à la prévention des accidents, il importe également de respecter les règles spécifiques et communément admises en matière de sécurité et de travail. Le mode d'emploi doit être complété des dispositions nationales applicables à la prévention des accidents et à la protection de l'environnement.
- La centrifugeuse a été construite conformément à l'état actuel de la technique et son fonctionnement est sûr. Elle peut cependant présenter des dangers pour l'utilisateur ou des tiers si son utilisation n'est pas confiée à un personnel dûment formé, est inadéquate ou non conforme à sa destination.
- Pendant le fonctionnement, la centrifugeuse ne devra pas être déplacée ou être heurtée.
- En cas de défaillance ou en cas de déverrouillage d'urgence, ne jamais intervenir dans l'appareil lorsque le rotor tourne.
- Afin d'éviter les dommages causés par la condensation en passant d'un local froid à un local chaud, il faut soit réchauffer la centrifugeuse en la laissant pendant au moins 3 heures dans le local chaud avant de la raccorder au secteur, soit la faire fonctionner pendant 30 minutes dans le local froid pour la chauffer.
- Seuls le rotor autorisé pour cet appareil par le fabricant et les accessoires autorisés peuvent être utilisés (voir chapitre "Anhang/Appendix, Rotoren und Zubehör/Rotors and accessories"). Avant d'utiliser des récipients de centrifugation qui ne sont pas présentés dans le chapitre "Annexe/Appendix, rotors et accessoire/Rotors and accessories", l'utilisateur doit s'assurer auprès du fabricant qu'il peut les utiliser.
- Le rotor de la centrifugeuse doit uniquement être chargé conformément au chapitre "Chargement du rotor".
- Dans le cas de la centrifugation à la vitesse maximale, la densité des substances et des mélanges de substances ne doit pas excéder $1,2 \text{ kg/dm}^3$.
- Il est interdit de procéder à des centrifugations en présence de défauts d'équilibrage.
- La centrifugeuse ne doit pas être exploitée dans un environnement explosif.
- Il est interdit de procéder à des centrifugations :
 - avec des matières inflammables ou explosives,
 - avec des matières susceptibles de réagir chimiquement ou de dégager d'importantes quantités d'énergie.
- En cas de centrifugation de substances dangereuses ou de substances mixtes toxiques, radioactives ou contaminées par des micro-organismes pathogènes, il incombe à l'utilisateur de prendre les mesures ad hoc. Il faut systématiquement utiliser des récipients de centrifugation avec des bouchons spéciaux à vis destinés aux substances dangereuses. Dans le cas des substances des groupes de risques 3 et 4, il faut utiliser un système de sécurité biologique en plus des récipients de centrifugation pouvant être obturés (voir le manuel "Laboratory Biosafety Manual" publié par l'Organisation Mondiale de la Santé).

En l'absence d'un système de sécurité biologique, une centrifugeuse n'est pas étanche du point de vue microbiologique au sens de la norme EN / IEC 61010-2-020.
 Cette centrifugeuse ne dispose pas de système de sécurité biologique.

- Il est interdit de centrifuger des matières fortement corrosives pouvant réduire la résistance mécanique des rotors, des supports et des accessoires.
- Les réparations ne peuvent être effectuées que par une personne autorisée à cet effet par le fabricant.
- Utiliser uniquement les pièces de rechange originales et les accessoires d'origine homologués par les Etablissements Andreas Hettich GmbH & Co. KG.
- Les dispositions de sécurité suivantes font foi :
 EN / IEC 61010-1 et EN / IEC 61010-2-020 ainsi que les dérogations nationales.
- La sécurité et la fiabilité de la centrifugeuse seront uniquement garanties si :
 - la centrifugeuse est utilisée conformément aux instructions du mode d'emploi,
 - l'installation électrique du site de la centrifugeuse est conforme aux prescriptions EN / IEC.
- Le fait de respecter les prescriptions nationales relatives à la sécurité au travail concernant l'utilisation de centrifugeuses de laboratoire sur le lieu de travail prévu à cet effet par l'exploitant relève de la responsabilité du dit exploitant.

7 Transport et stockage

7.1 Transport



Installer le dispositif de sécurité pour le transport avant de transporter l'appareil.

Respecter les conditions ambiantes suivantes pour transporter l'appareil et ses accessoires :

- Température ambiante : -20°C à +60°C
- Humidité relative de l'air : 20% à 80%, non condensante

7.2 Stockage



Ne stocker l'appareil et ses accessoires que dans une pièce fermée au sec.

Respecter les conditions ambiantes suivantes pour stocker l'appareil et ses accessoires :

- Température ambiante : -20°C à +60°C
- Humidité relative de l'air : 20% à 80%, non condensante

8 Etendue de la livraison

Les accessoires suivants sont fournis avec la centrifugeuse:

- 1 câble de raccordement
- 2 fusibles
- 1 clé mâle six-pans
- 1 mode d'emploi
- 1 fiche de notes concernant la sécurité du transport
- 1 fiche de notes concernant le déverrouillage de secours

Le(s) rotor(s) et accessoires correspondant sont livrés selon les spécifications de la commande.

9 Retirer les dispositifs de sécurité pour le transport



Retirez impérativement les dispositifs de sécurité pour le transport.

Conservez ces dispositifs de sécurité afin de les réutiliser lors du transport ultérieur de l'appareil (leur montage est obligatoire).

Le transport de l'appareil est exclusivement autorisé avec les dispositifs de sécurité correspondants.

Pour protéger l'appareil pendant le transport, on fixe le moteur.

Retirez impérativement ces dispositifs de sécurité pour le transport avant la mise en service de l'appareil.

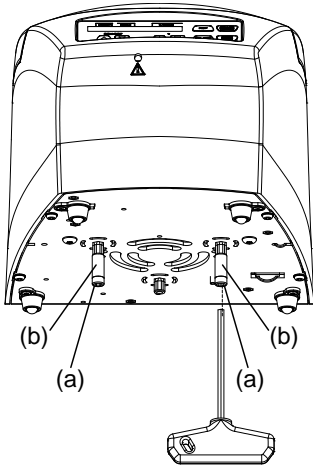

- Enlevez les deux vis (a) et douilles d'écartement (b).



Pour remonter les dispositifs de sécurité pour le transport, procédez dans l'enchaînement inverse.

10 Mise en service

- Retirez les dispositifs de sécurité pour le transport au fond du boîtier, voir chapitre "Retirer les dispositifs de sécurité pour le transport".
- **Placer la centrifugeuse sur un emplacement approprié de manière à ce qu'elle soit stable et mettre de niveau. Lors de la mise en place, il faut respecter la zone de sécurité exigée de 300mm autour de la centrifugeuse selon EN / IEC 61010-2-020.**



Durant un processus de centrifugation, aucune personne, matière dangereuse et aucun objet ne doivent se trouver dans une zone de sécurité de 300 mm autour de la centrifugeuse selon EN / IEC 61010-2-020.

- Ne pas recouvrir les fentes d'aération.
Veuillez respecter un écart de 300 mm jusqu'aux fentes et ouvertures d'aération de la centrifugeuse.
- Vérifier que la tension de secteur est identique à la mention de la plaque signalétique.
- Brancher la centrifugeuse avec son cordon de raccordement sur une prise secteur aux normes. Puissance connectée voir chapitre "Données techniques".
- Allumer l'interrupteur de réseau (position du commutateur "I").
Vous voyez s'afficher successivement :
 1. le modèle de centrifugeuse
 2. le numéro type et la version du programme
 3. les données de la dernière centrifugation utilisée



Quand le couvercle est fermé, le message "Open the lid" s'affiche.
Dans ce cas, ouvrir le couvercle afin que les données de centrifugation s'affichent.

11 Ouvrir et fermer le couvercle

11.1 Ouvrir le couvercle



Vous ne pouvez ouvrir le couvercle que si la centrifugeuse est en marche et le rotor à l'arrêt. Si cela n'est pas possible, consulter le chapitre "Déverrouillage d'urgence".



Si le compteur de cycles est activé, le nombre de cycles de centrifugation restants s'affiche brièvement, après un cycle de centrifugation, pendant l'ouverture du couvercle.

Exemple :



- Appuyer sur la touche.
Le couvercle se déverrouille de manière motorisée.
☒ : couvercle déverrouillé.

Exemple :



11.2 Fermer le couvercle



Ne pas mettre les doigts entre le couvercle et le boîtier.
Ne pas fermer le couvercle violemment.

- Poser le couvercle et appuyer légèrement sur le bord avant du couvercle.
Le couvercle se verrouille de manière motorisée.
☒ : couvercle verrouillé.

Exemple :

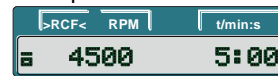

12 Montage et démontage du rotor

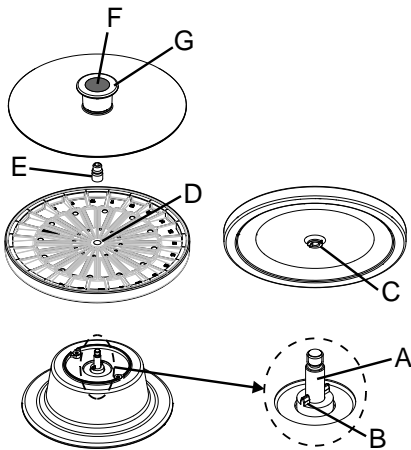

Montage :

- Poser le rotor à la verticale sur l'arbre moteur (A) et pousser vers le bas. L'entraîneur (B) sur l'arbre moteur doit se trouver dans la rainure (C) du rotor. La direction de la rainure est indiquée sur le rotor (D).
- À l'aide de la clé hexagonale fournie, visser l'écrou de fixation (E) sur l'arbre moteur (A) en tournant dans le sens des aiguilles d'une montre, et bien serrer.



L'écrou de fixation (E) doit toujours être serré sur l'arbre moteur (A).

- Vérifier si le rotor se trouve dans une position fixe.
- Poser le couvercle sur le rotor et pousser vers le bas sur la poignée, jusqu'à ce que le couvercle s'enclenche.

Démontage :

- Pousser sur le bouton (F) dans la poignée du couvercle, tirer en même temps vers le haut l'anneau extérieur (G) de la poignée et retirer le couvercle du rotor.
- À l'aide de la clé hexagonale fournie, dévisser l'écrou de fixation (E) en tournant dans le sens inverse des aiguilles d'une montre, et le retirer.
- Ôter le rotor de l'arbre moteur (A).

13 Chargement du rotor

- Vérifier la stabilité d'assise du rotor.
- Retirer le couvercle du rotor :
Pousser sur le bouton (F) dans la poignée du couvercle, tirer en même temps vers le haut l'anneau extérieur (G) de la poignée et retirer le couvercle du rotor. Illustration, voir chapitre "Montage et démontage du rotor".
- Ne charger le rotor que de manière symétrique. Les conteneurs de centrifugation doivent être uniformément répartis sur toutes les positions du rotor. Pour les combinaisons possibles, voir le Chapitre "Anhang/Appendix, Rotoren und Zubehör/Rotors and accessories".

Exemple:

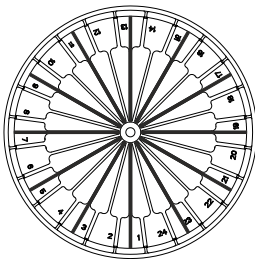

Rotor uniformément chargé

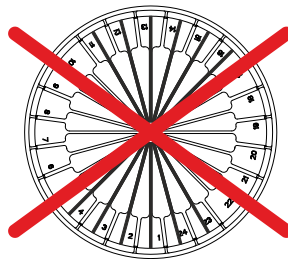

Non autorisé !
Rotor irrégulièrement chargé

- Pour déterminer l'hématocrite on remplit toujours les capillaires à $\approx 75\%$.
- Aucun fluide ne doit pénétrer dans le rotor et dans la cuve de centrifugeuse lors du chargement du rotor.
- En cas d'utilisation de tubes capillaires standards, les insérer dans le rotor côté mastic vers l'extérieur. En cas d'utilisation de tubes capillaires auto-étanches, les insérer dans le rotor côté extrémité du bouchon vers l'extérieur.
- Une fois le rotor chargé, poser le couvercle sur le rotor et pousser vers le bas sur la poignée jusqu'à ce que le couvercle s'enclenche.

14 Éléments de commande et d'affichage

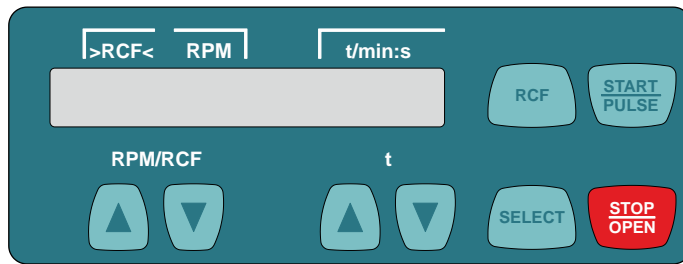

14.1 Pictogrammes



Couvercle déverrouillé.



Couvercle verrouillé.



Affichage de la rotation. L'affichage de rotation brille en tournant dans le sens inverse des aiguilles d'une montre tant que le rotor tourne.

14.2 Touches du champ de commande

RPM/RCF



- Saisir directement la vitesse de rotation.
- Pour faire défiler plus rapidement les valeurs, maintenez la touche enfoncée.

t



- Saisir directement la durée de fonctionnement.
- Réglable en étapes de 1 seconde jusqu'à 1 minute et en étapes de 1 minute à partir de 1 minute.
- Saisir les paramètres de centrifugation.

Pour faire défiler plus rapidement les valeurs, maintenez la touche enfoncée.



- Touche de sélection de chaque paramètre.
- Chaque pression supplémentaire de la touche permet de sélectionner le paramètre suivant.
- Appeler "MACHINE MENU" (appuyer sur la touche pendant 8 secondes).
- Dans "Machine Menu", sélectionner les menus "→ Info", "→ Settings" et "→ Time & Cycles".
- Faire défiler les menus vers l'avant.



- Passer de l'affichage RPM (RPM) à l'affichage RCF (>RCF<) et inversement.
- Les valeurs RCF s'affichent entre parenthèses ><.

RPM: vitesse de rotation
RCF : accélération centrifuge relative



- Lancer le cycle de centrifugation.
- Cycle de centrifugation court.
- Le cycle de centrifugation tourne tant que vous appuyez la touche.
- Appeler les menus "→ Info", "→ Settings" et "→ Time & Cycles".



- Terminer le cycle de centrifugation.
- Le rotor s'arrête avec le niveau de freinage présélectionné.
- Appuyer deux fois la touche pour déclencher l'arrêt d'urgence.
- Déverrouiller le couvercle.

14.3 Réglages possibles

t/min **Durée de fonctionnement.** Réglable de 1 à 99 min, en étapes de 1 minute.

t/sec **Durée de fonctionnement.** Réglable de 1 à 59 s, en étapes de 1 seconde.

Fonctionnement continu "--:--". Mettre les paramètres **t/min** et **t/sec** sur zéro.

RPM **Vitesse de rotation**

Vous pouvez saisir une valeur numérique pour paramétrer un régime de 200 RPM jusqu'à vitesse maximum du rotor.

Réglable de 200 RPM jusqu'à 10000 RPM en étapes de 10, et à partir de 10000 RPM en étapes de 100.

Vitesse maximum du rotor, voir chapitre "Annexe/Appendix, rotors et accessoires/Rotors and accessories".

>RCF< **Accélération centrifuge relative**

Vous pouvez saisir une valeur numérique pour paramétrer un régime de 200 RPM jusqu'à vitesse maximum du rotor.

Réglable jusqu'à 10000 en étapes de 1, et à partir de 10000 en étapes de 10.



La saisie des données pour l'accélération centrifuge relative (RCF) n'est possible que si l'affichage RCF (>RCF<) est sélectionné.

L'accélération centrifuge relative (RCF) dépend du rayon de centrifugation (RAD). Après saisie des données de RCF, vérifier que le rayon de centrifugation réglé soit correct.

RAD/mm **Rayon de centrifugation**

Réglable de 10 mm à 250 mm, en étapes de 1 millimètre.

Rayon de centrifugation, voir chapitre "Annexe/Appendix, rotors et accessoires/Rotors and accessories".







La saisie du rayon de centrifugation n'est possible que si l'affichage RCF (>RCF<) est sélectionné.

~_DEC **Niveau de freinage.** **fast** = temps d'arrêt court, **slow** = temps d'arrêt long.

15 Saisir les paramètres de centrifugation

15.1 Saisie directe des paramètres de centrifugation

Vous pouvez saisir directement la vitesse de rotation (RPM), l'accélération centrifuge relative (RCF), le rayon de centrifugation (RAD) et la durée de fonctionnement avec les touches   sans devoir appuyer préalablement la touche .

 Les paramètres de centrifugation réglés ne sont enregistrés qu'après démarrage du cycle de centrifugation.

15.1.1 Vitesse de rotation (RPM)



- Au besoin, appuyez la touche pour sélectionner l'affichage de RPM.



- Réglez la valeur souhaitée avec les touches.

Exemple :

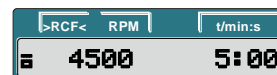

15.1.2 Accélération centrifuge relative (RCF) et rayon de centrifugation (RAD)



- Au besoin, appuyez la touche pour sélectionner l'affichage RCF (>RCF<).



- Régler la valeur RCF souhaitée avec les touches.

Exemple :

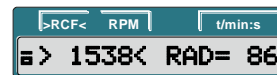
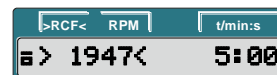

- Au besoin, réglez le rayon de centrifugation souhaité avec les touches.

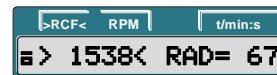

15.1.3 Durée de fonctionnement

 Vous pouvez régler la durée de fonctionnement jusqu'à 1 minute en étapes de 1 seconde, mais à partir de 1 minute, seulement en étapes de 1 minute.

Pour régler fonctionnement continu, il faut mettre les paramètres **t/min** et **t/sec** sur zéro. L'affichage temps (t/min:s) indique "--:--".

Exemple:

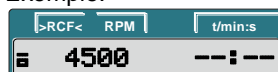

Exemple :



- Réglez la valeur souhaitée avec les touches.

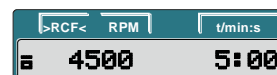

15.2 Saisie des paramètres de centrifugation avec la touche "SELECT"



Vous pouvez régler la durée de fonctionnement en minutes et secondes (paramètres **t/min** et **t/sec**).

Pour tourner en fonctionnement continu il faut mettre les paramètres **t/min** et **t/sec** sur zéro. L'affichage temps (t/min:s) indique "--:--".

Exemple:





L'accélération centrifuge relative (RCF) dépend du rayon de centrifugation (RAD).

Pendant la saisie des données de l'accélération RCF, le rayon de centrifugation configuré s'affiche..

Si, après ou pendant la saisie de paramètres, vous n'appuyez pas de touche pendant 8 secondes, les paramètres précédents réapparaissent. Vous devez alors recommencer la saisie des paramètres.







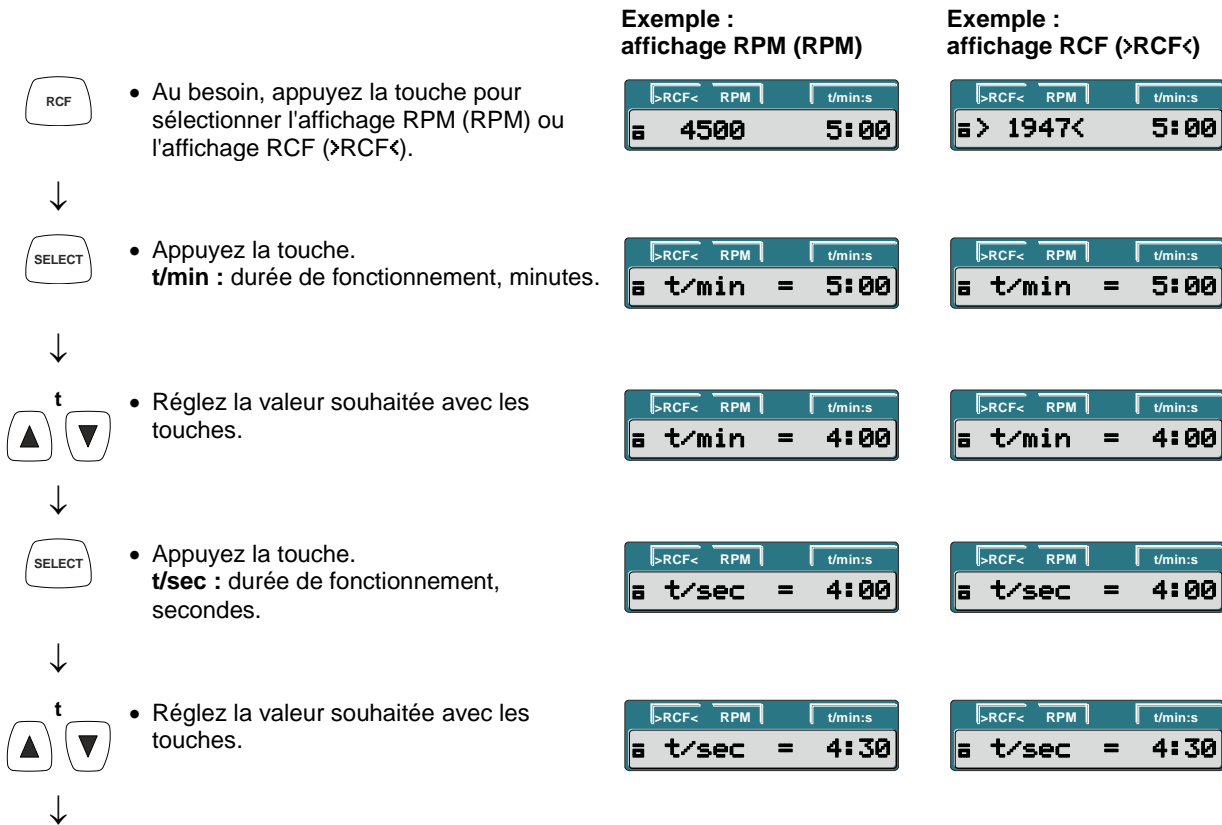



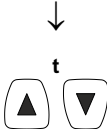

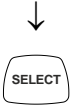

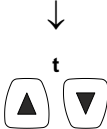



Appuyer sur la touche  pour enregistrer les réglages.

Si vous saisissez plusieurs paramètres, n'appuyez la touche  qu'après avoir entré le dernier paramètre.

Vous pouvez à tout moment interrompre la saisie des paramètres en appuyant la touche . Auquel cas, les réglages ne seront pas enregistrés.



Suite page suivante

	<ul style="list-style-type: none"> Appuyez la touche. RPM : vitesse de rotation (rotation par minute). RAD/mm : rayon de centrifugation. L'affichage et la saisie du rayon de centrifugation n'est possible que si l'affichage RCF (>RCF<) est sélectionné. 	Exemple : affichage RPM (RPM)	Exemple : affichage RCF (>RCF<)
	<ul style="list-style-type: none"> Réglez la valeur souhaitée avec les touches. 		
	<ul style="list-style-type: none"> Appuyez la touche. R : rayon de centrifugation. RCF : accélération centrifuge relative. 		
	<ul style="list-style-type: none"> Réglez la valeur souhaitée avec les touches. 		
	<ul style="list-style-type: none"> Appuyez la touche. _DEC : niveau de freinage. fast : temps d'arrêt court. slow : temps d'arrêt long. 		
	<ul style="list-style-type: none"> Réglez la valeur souhaitée avec les touches. 		
	<ul style="list-style-type: none"> Appuyer sur la touche pour enregistrer les. 		
			

16 Centrifugation



Pendant un cycle de centrifugation, conformément à la norme européenne/ IEC 61010-2-020, veillez à ce que personne, ni substance dangereuse ni objet, ne se trouve dans la zone de sécurité de 300 mm autour de la centrifugeuse.



En cas de dépassement de la différence de poids autorisée pour la charge du rotor, le cycle de centrifugation est interrompu au démarrage et le message suivant apparaît :



Vous pouvez à tout moment interrompre un cycle de centrifugation en appuyant la touche .

Vous pouvez sélectionner et modifier les paramètres de centrifugation pendant un cycle de centrifugation. Toutefois, les valeurs modifiées dans ces conditions ne s'appliqueront qu'au cycle de centrifugation en cours, elles ne seront pas enregistrées.

Avec la touche , vous pouvez à tout moment commuter entre l'affichage RPM (RPM) et l'affichage RCF (>RCF<). Pour travailler avec l'affichage RCF (>RCF<), il faut saisir les données du rayon de centrifugation.

Si le message suivant s'affiche,



cela signifie que vous ne pourrez continuer à utiliser la centrifugeuse qu'après ouverture du couvercle.

Erreurs de commande et dérangements s'affichent (voir chapitre "Dérangements").

- Allumer l'interrupteur de réseau. Position du commutateur I.
- Charger le rotor et fermer le couvercle de la centrifugeuse.

16.1 Centrifugation avec présélection temps



- Au besoin, appuyez la touche pour sélectionner l'affichage RPM (RPM) ou l'affichage RCF (>RCF<).





- Saisir les paramètres de centrifugation souhaités (voir chapitre "Saisir les paramètres de centrifugation").



- Appuyez la touche pour lancer le cycle de centrifugation. Pendant le cycle de centrifugation, l'écran affiche la vitesse de rotation du rotor ou la valeur RCF en résultant, ainsi que le temps restant.



- A échéance du temps paramétré ou en cas d'arrêt du cycle de centrifugation avec la touche , l'arrêt se déclenche avec le niveau de freinage paramétré. Le niveau de freinage s'affiche. Exemple .

Exemple : affichage RPM (RPM)



Exemple : affichage RCF (>RCF<)

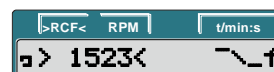
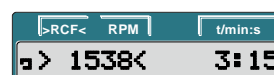
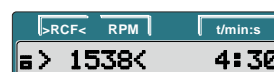

16.2 Fonctionnement continu



- Au besoin, appuyez la touche pour sélectionner l'affichage RPM (RPM) ou l'affichage RCF (>RCF<).



- Saisir les paramètres de centrifugation souhaités. Mettre les paramètres **t/min** et **t/sec** sur zéro (voir chapitre "Saisir les paramètres de centrifugation").



- Appuyez la touche pour lancer le cycle de centrifugation.
Pendant le cycle de centrifugation, l'écran affiche la vitesse de rotation du rotor ou la valeur RCF en résultant, ainsi que le temps écoulé.



- Appuyez la touche pour terminer le cycle de centrifugation.
L'arrêt se déroule avec le niveau de freinage réglé. Le niveau de freinage s'affiche. Exemple $\sim f$

Exemple : affichage RPM (RPM)

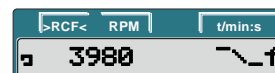

Exemple : affichage RCF (>RCF<)



16.3 Cycle de centrifugation court



- Au besoin, appuyez la touche pour sélectionner l'affichage RPM (RPM) ou l'affichage RCF (>RCF<).



- Saisir les paramètres de centrifugation souhaités (voir chapitre "Saisir les paramètres de centrifugation").



- Appuyez la touche et maintenez la enfoncée.
Pendant le cycle de centrifugation, l'écran affiche la vitesse de rotation du rotor ou la valeur RCF en résultant, ainsi que le temps écoulé.



- Relâchez la touche pour terminer le cycle de centrifugation.
L'arrêt se déroule avec le niveau de freinage réglé. Le niveau de freinage s'affiche. Exemple $\sim f$.

Exemple : affichage RPM (RPM)

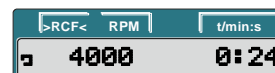
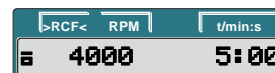

Exemple : affichage RCF (>RCF<)

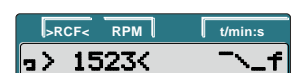
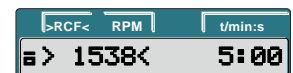

17 Arrêt d'urgence



- Appuyez la touche deux fois.
En cas d'arrêt d'urgence, l'arrêt se déroule avec le niveau de freinage "fast" (temps d'arrêt court). Le niveau de freinage \sim f s'affiche.

Exemple :
affichage RPM (RPM)



Exemple :
affichage RCF (>RCF<)



18 Réglages et demandes

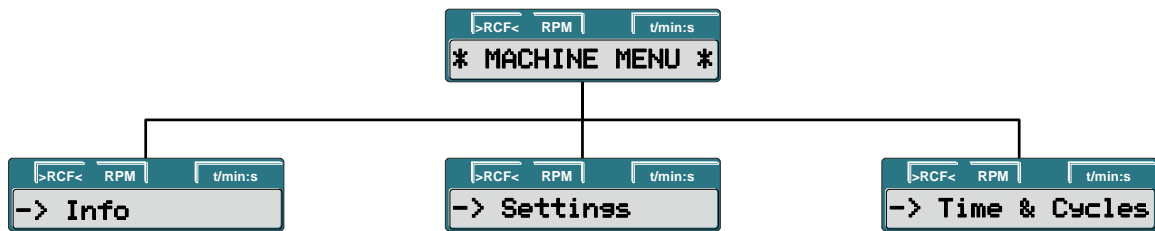

Demande:

- Informations système

Réglage:

- Signal sonore
- Déverrouillage automatique du couvercle après le cycle de centrifugation
- Arrêt automatique de l'éclairage d'arrière-plan
- Signal optique à la fin du cycle de centrifugation

Demande:



- Heures de fonctionnement
- Nombre de cycles de centrifugation exécutés

18.1 Demander des informations sur le système

Vous pouvez demander les informations-système suivantes:

- Modèle d'appareil,
- Version du programme de l'appareil,
- numéro du type de l'appareil,
- Date de fabrication de l'appareil,
- Numéro de série de l'appareil,
- type du convertisseur de fréquence,
- version du programme du convertisseur de fréquence

Lorsque le rotor est à l'arrêt, procédez comme suit pour vos demandes d'informations:

 Vous pouvez à tout moment interrompre la procédure en appuyant la touche .



- Appuyez la touche pendant 8 secondes.



- Appuyez la touche.



- Appuyez la touche.
Modèle d'appareil



- Appuyez la touche.
Version du programme de l'appareil.

Exemple:



- Appuyez la touche.
Type#1 : numéro du type de l'appareil.

Exemple:



- Appuyez la touche.
Type#2 : suite du numéro du type s'il a plus de positions que le champ d'affichage "**Type#1**".

Exemple:

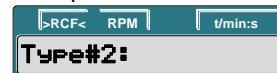

- Appuyez la touche.
Date de fabrication de l'appareil.

Exemple:

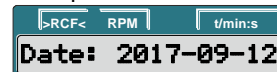

Suite page suivante



- Die Taste drücken.
Numéro de série de l'appareil.

Exemple:



- Appuyez la touche.
Type du convertisseur de fréquence.

Exemple :



- Appuyez la touche.
Version du programme du convertisseur de fréquence.

Exemple :



- Appuyez deux fois la touche pour quitter le menu
"-> Info" ou trois fois pour quitter le
"*MACHINE MENU*".

Exemple :





18.2 Signal sonore

















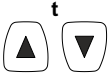



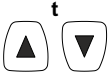

Le signal sonore retentit:

- en intervalles de 2 secondes en cas de dérangement.
- en intervalles de 30 secondes une fois le cycle de centrifugation terminé et le rotor arrêté.

Appuyez n'importe quelle touche pour arrêter le signal sonore.

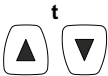
Lorsque le rotor est à l'arrêt, vous pouvez régler le signal sonore en procédant comme suit :

 Vous pouvez à tout moment interrompre la procédure en appuyant la touche . Auquel cas, les réglages ne seront pas pris en compte.

	• Appuyez la touche pendant 8 secondes.		
↓			
	• Appuyez sur la touche jusqu'à affichage de l'écran suivant.		
↓			
	• Appuyez la touche. End beep : Signal sonore à la fin du cycle de centrifugation. off : signal désactivé. on : signal activé.		
↓			
	• Sélectionnez off (Arrêt) ou on (Marche) avec les touches.		
↓			
	• Appuyez la touche. Error beep : signal sonore dès apparition d'un dérangement. off : signal désactivé. on : signal activé.		
↓			
	• Sélectionnez off (Arrêt) ou on (Marche) avec les touches.		
↓			
	• Appuyez la touche. Beep volume : volume du signal sonore. min : bas mid : moyen max : fort		
↓			
↓			
	• Sélectionnez min , mid , ou max avec les touches.		
↓			

Suite page suivante



- Appuyez la touche pour enregistrer le réglage.

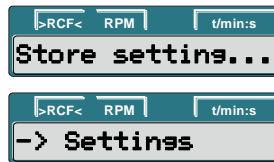

- Appuyez cette touche une fois pour quitter le menu "-> Settings" ou deux fois pour quitter le "* MACHINE MENU *".





Exemple :



18.3 Signal optique à la fin du cycle de centrifugation

A la fin du cycle de centrifugation, l'éclairage en arrière-plan de l'affichage clignote pour vous signaler optiquement que le cycle de centrifugation est terminé.

Lorsque le rotor est à l'arrêt, vous pouvez activer ou désactiver le signal optique comme suit:

 Vous pouvez à tout moment interrompre la procédure en appuyant la touche .



- Appuyez la touche pendant 8 secondes.



- Appuyez sur la touche jusqu'à affichage de l'écran suivant.



- Appuyez la touche.



- Appuyez sur la touche jusqu'à affichage de l'un des deux écrans.
End blinking : clignotement de l'éclairage d'arrière-plan après le cycle de centrifugation.
off : l'éclairage d'arrière-plan ne clignote pas.
on : l'éclairage d'arrière-plan clignote.



- Sélectionnez **off** (Arrêt) ou **on** (Marche) avec les touches.



- Appuyez la touche pour enregistrer le réglage.



- Appuyez cette touche une fois pour quitter le menu "-> Settings" ou deux fois pour quitter le "* MACHINE MENU *".



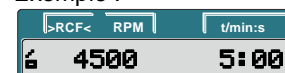

Exemple :





















18.4 Déverrouillage automatique du couvercle après le cycle de centrifugation

Vous pouvez paramétrer si le couvercle doit se déverrouiller automatiquement ou pas après le cycle de centrifugation.

Lorsque le rotor est à l'arrêt, vous pouvez procéder comme suit pour ce faire:



 Vous pouvez à tout moment interrompre la procédure en appuyant la touche . Auquel cas, les réglages ne seront pas pris en compte.



















	<ul style="list-style-type: none"> • Appuyez la touche pendant 8 secondes. 		
↓			
	<ul style="list-style-type: none"> • Appuyez sur la touche jusqu'à affichage de l'écran suivant. 		
↓			
	<ul style="list-style-type: none"> • Appuyez la touche. 		
↓			
	<ul style="list-style-type: none"> • Appuyez sur la touche jusqu'à affichage de l'un des deux écrans. Lid AutoOpen : déverrouillage automatique du couvercle après le cycle de centrifugation. off : pas de déverrouillage automatique du couvercle. on : déverrouillage automatique du couvercle. 		
↓			
	<ul style="list-style-type: none"> • Sélectionnez off ou on avec les touches. 		
↓			
	<ul style="list-style-type: none"> • Appuyez la touche pour enregistrer le réglage. 		
↓			
	<ul style="list-style-type: none"> • Appuyez cette touche une fois pour quitter le menu "-> Settings" ou deux fois pour quitter le "* MACHINE MENU *". 		<p>Exemple :</p> 

18.5 Eclairage d'arrière-plan de l'affichage

Pour économiser de l'énergie, vous pouvez paramétrer si, après un cycle de centrifugation, l'éclairage d'arrière-plan de l'affichage doit s'éteindre au bout de 2 minutes.

Lorsque le rotor est à l'arrêt, vous pouvez procéder comme suit pour ce faire:

 Vous pouvez à tout moment interrompre la procédure en appuyant la touche . Auquel cas, les réglages ne seront pas pris en compte.

	<ul style="list-style-type: none"> Appuyez la touche pendant 8 secondes. 		
↓			
	<ul style="list-style-type: none"> Appuyez sur la touche jusqu'à affichage de l'écran suivant. 		
↓			
	<ul style="list-style-type: none"> Appuyez la touche. 		
↓			
	<ul style="list-style-type: none"> Appuyez sur la touche jusqu'à affichage de l'un des deux écrans. Power save : arrêt automatique de l'éclairage d'arrière-plan. off : arrêt automatique désactivé. on : arrêt automatique activé. 		
↓			
	<ul style="list-style-type: none"> Sélectionnez off (Arrêt) ou on (Marche) avec les touches. 		
↓			
	<ul style="list-style-type: none"> Appuyez la touche pour enregistrer le réglage. 		
↓			
	<ul style="list-style-type: none"> Appuyez cette touche une fois pour quitter le menu "-> Settings" ou deux fois pour quitter le "* MACHINE MENU *". 		<p>Exemple :</p> 



18.6 Demander les heures de fonctionnement et le nombre de cycles de centrifugation

Les heures de fonctionnement sont réparties en heures de service internes et externes.

Heures de service internes: durée totale pendant laquelle l'appareil était enclenché.

Heures de service externes: durée totale des cycles de centrifugation effectués jusque maintenant.

Lorsque le rotor est à l'arrêt, procédez comme suit pour vos demandes d'informations:

 Vous pouvez interrompre à tout moment en appuyant la touche .



- Appuyez la touche pendant 8 secondes.



- Appuyez sur la touche jusqu'à affichage de l'écran suivant.



- Appuyez la touche.
TimeExt : heures de service externes.

Exemple :



- Appuyez la touche.
TimeInt : heures de service internes.

Exemple :



- Appuyez la touche.
Starts : nombre total des cycles de centrifugation.

Exemple :



- Appuyez la touche deux fois pour quitter le menu
"-> Time & Cycles" ou trois fois pour quitter le "* MACHINE MENU *".

Exemple :

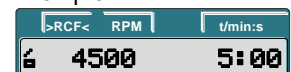

19 Accélération centrifuge relative (RCF)

L'accélération centrifuge relative (RCF) est indiquée en tant que multiple de l'accélération gravitationnelle (g). Il s'agit d'une valeur dépourvue d'unité, qui sert à la comparaison entre la puissance de séparation et de sédimentation.

Le calcul s'effectue à l'aide de la formule suivante:

$$\text{RCF} = \left(\frac{\text{RPM}}{1000} \right)^2 \times r \times 1,118 \quad \Rightarrow \quad \text{RPM} = \sqrt{\frac{\text{RCF}}{r \times 1,118}} \times 1000$$

RCF = accélération centrifuge relative

RPM = régime

r = rayon de centrifugation en mm = distance qui sépare le centre de l'axe de rotation du fond de la cuve de centrifugation. Rayon de centrifugation voir chapitre "Anhang/Appendix, Rotoren und Zubehör/Rotors and accessories".



L'accélération centrifuge relative (RCF) est dépendante du régime et du rayon de centrifugation.

20 Centrifugation de matières et de mélanges d'une densité supérieure à 1,2 kg/dm³

Dans le cas de la centrifugation à la vitesse maximale, la densité des substances et des mélanges de substances ne doit pas excéder 1,2 kg/dm³. Réduire la vitesse de rotation pour les matières et mélanges ayant une densité supérieure.

La vitesse de rotation autorisée se calcule de la manière suivante:

$$\text{Vitesse de centrifugation lente (n}_{\text{red}}) = \sqrt{\frac{1,2}{\text{densité supérieure [kg/dm}^3]}} \times \text{Vitesse de rotation maximum [RPM]}$$

Exemple: Vitesse de rotation maximum RPM 4000, densité 1,6 kg/dm³

$$n_{\text{red}} = \sqrt{\frac{1,2 \text{ kg/dm}^3}{1,6 \text{ kg/dm}^3}} \times 4000 \text{ RPM} = 3464 \text{ RPM}$$

En cas d'incertitude, prendre contact avec le fabricant.

21 Détermination de l'hématocrite

21.1 Déterminer le temps de centrifugation

Utiliser la formule d'approche suivante pour déterminer le temps de centrifugation :

$$\frac{100000}{\text{RCF}} = \text{temps de centrifugation en minutes}$$

RCF = Accélération centrifuge relative

Calcul de la RCF, voir chapitre "Accélération centrifuge relative (RCF)".

Exemple :

RCF = 16060

$$\frac{100000}{16060} = 6,23 \text{ minutes} = 6 \text{ minutes et } 14 \text{ secondes}$$

En cas de RCF de 16060, le temps de centrifugation est de 6 minutes et 14 secondes.

21.2 Lire la valeur hématocrite

Procéder comme suit pour lire la valeur hématocrite :

- Bien tenir le rotor.
- Tourner le disque d'évaluation (couvercle du rotor) jusqu'à ce que la ligne 100% du disque d'évaluation corresponde au bord supérieur de la colonne de liquide dans le tube capillaire.
- Lire la valeur hématocrite sur le bord supérieur de la colonne érythrocyte.

Répéter la procédure jusqu'à ce que tous les tubes capillaire aient été évalués.

22 Déverrouillage de secours

En cas de panne de courant, il est impossible de déverrouiller le couvercle par voie moteur. Il faut donc procéder à un déverrouillage de secours manuel.



Pour un déverrouillage de secours, débranchez la centrifugeuse du réseau. N'ouvrez le couvercle que si le rotor est à l'arrêt.



PRUDENCE! Lors du déverrouillage de secours, si vous tournez la clé six-pans dans le sens des aiguilles d'une montre (à droite), vous endommagez le verrou.

Ne tournez la clé six-pans que dans le sens inverse des aiguilles d'une montre (vers la gauche), voir illustration.

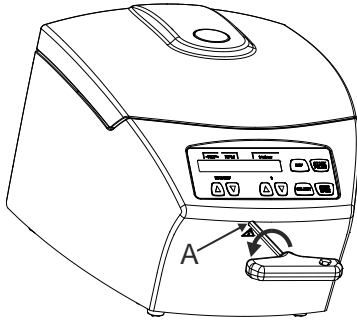

- Débranchez la tension du réseau en mettant l'interrupteur en position "0".
- Vérifiez par la fenêtre du couvercle que le rotor est bien à l'arrêt.
- Insérez la clé six-pans à l'horizontale dans l'ouverture A et tournez-la avec précaution dans le sens inverse des aiguilles d'une montre (vers la gauche) jusqu'à ouverture du couvercle.
- Retirez la clé six-pans de l'ouverture.

23 Entretien et maintenance



L'appareil est peut-être contaminé.



Retirer la prise de secteur avant de nettoyer.

Avant d'utiliser une procédure de nettoyage ou de décontamination autre que celle recommandée par le fabricant, l'utilisateur vérifiera auprès du fabricant que la procédure prévue n'endommage pas l'appareil.

- Ne pas nettoyer centrifuges, rotors et accessoires dans un lave-vaisselle.
- Seul le nettoyage manuel et une désinfection liquide sont autorisés.
- La température de l'eau doit être située entre 20 et 25°C.
- Utiliser exclusivement des agents de nettoyage ou de désinfection qui :
 - ont un pH de 5 à 8,
 - ne contiennent pas de substances caustiques, de peroxyde, composés chlorés, acides ni alcalins.
- Respecter impérativement les consignes spéciales d'utilisation données par le fabricant des agents de nettoyage et de désinfection, afin de prévenir la corrosion par les agents de nettoyage et de désinfection.



Le disque de la centrifugeuse, le couvercle du disque de la centrifugeuse, les coques de rembourrage et les joints ne peuvent pas passer à l'autoclave.

23.1 Centrifugeuse (boîtier, couvercle et cuve)

23.1.1 Entretien et nettoyage des surfaces

- Nettoyer régulièrement le boîtier de la centrifugeuse et le compartiment de centrifugation et les laver en cas de besoin avec du savon ou un détergent doux et un chiffon humide. Ces opérations sont nécessaires pour garantir l'hygiène et pour prévenir la corrosion par la présence durable d'impuretés.
- Substances des nettoyeurs adéquats :
savon, agents anioniques et non ioniques.
- Après utilisation des nettoyeurs, enlevez les résidus en essuyant l'appareil avec un chiffon humide.
- Séchez immédiatement les surfaces après nettoyage.
- Sécher le bol avec un chiffon absorbant en cas de dépôt d'eau de condensation dans le bol de la centrifugeuse.
- Frotter légèrement le joint d'étanchéité en caoutchouc du compartiment de centrifugation, après chaque nettoyage, avec de la poudre de talc ou un produit d'entretien pour caoutchouc.
- Vérifiez tous les ans le bon état de la cuve.



N'utilisez plus la centrifugeuse si elle présente des dommages susceptibles de porter atteinte à la sécurité. Auquel cas, contactez le service après-vente.

23.1.2 Désinfection des surfaces

- Le bol de la centrifugeuse doit être nettoyé immédiatement dans le cas où un matériau infectieux a pénétré dans le bol de la centrifugeuse.
- Substances des désinfectants adéquats :
éthanol, n-propanol, éthylènehexanol, agents anioniques, inhibiteurs de corrosion.
- Après utilisation de désinfectants, enlevez les résidus en essuyant l'appareil avec un chiffon humide.
- Séchez immédiatement les surfaces après désinfection.

23.1.3 Décontamination de substances radioactives

- L'agent employé doit expressément convenir pour une décontamination de substances radioactives.
- Substances des agents adaptés à une décontamination des substances radioactives :
agents anioniques, non ioniques agents, éthanol polyhydre.
- Après décontamination des substances radioactives, enlevez les résidus en essuyant l'appareil avec un chiffon humide.
- Séchez immédiatement les surfaces après décontamination des substances radioactives.

23.2 Nettoyage et désinfection du disque de centrifugation

Si, malgré toutes les mesures de protection, des capillaires pour hématocrite venaient tout de même à se vider durant la centrifugation, le cylindre et le couvercle doivent être nettoyés. En ce cas veillez à procéder de la manière suivante :

- Sortir précautionneusement les coques de rembourrage ou les joints du disque de la centrifugeuse.
- Déposer le disque de la centrifugeuse, le couvercle, ainsi que les coques de rembourrage ou le joint circulaire dans de l'eau froide, jusqu'à ce que les restes des sangs se soient complètement décollés.
- Procéder à la désinfection de manière appropriée. L'utilisation de désinfectants doit être évitée le plus possible sur le couvercle, pour ne pas décoller l'étiquette.
Substances des désinfectants adéquats : glutaraldehyde, propanol, éthylènehexanol, agents anioniques, inhibiteurs de corrosion.
Substances des agents adaptés à une décontamination des substances radioactives : agents anioniques, agents non ioniques, éthanol polyhydre.
- Rincer les pièces à l'eau froide et les essuyer.
- Elles peuvent alors être remises en place dans la centrifugeuse.

23.3 Manière de procéder en cas de capillaires brisés



Danger de blessures !

Il vaut mieux travailler avec une double paire de gants. A cause des débris de verre qui peuvent être projetés porter des lunettes de sécurité et un masque de protection !

- Ôter avec précaution le couvercle du disque de centrifugation
- Retirer avec une pincette les plus gros débris de capillaires.
- Sortir le disque de centrifugation. Sortir les coques de rembourrage concernées ou le joint circulaire précautionneusement et lentement à l'aide de la pincette et les échanger.
- Nettoyer et désinfecter comme c'est décrit ci-dessus.

23.3.1 Rotors et accessoires à durée d'utilisation limitée

L'utilisation du rotor, n° de réf. 2076, est limitée dans le temps.

La date d'expiration est indiquée sur le rotor, par exemple : "einsetzbar bis Ende: IV. Quartal 2019 / usable until end of: IV. Quartal 2019" (utilisation autorisée jusqu'à fin: IV. trimestre 2019).



Pour des raisons de sécurité, ne plus utiliser le rotor une fois la date d'expiration indiquée atteinte.

24 Défaits



Si l'erreur ne peut pas être éliminée d'après le tableau des défauts, il faut alors avertir le service après-vente.

Veillez indiquer le type de centrifugeuse et le numéro de série. Les deux numéros sont indiqués sur la plaque signalétique de la centrifugeuse.



Effectuer une RÉINITIALISATION DU SECTEUR :

- Couper l'interrupteur de secteur (position de l'interrupteur "0").
- Attendre au moins 10 secondes et refermer ensuite l'interrupteur de secteur (position de l'interrupteur "I").

Message / Erreur		Origine	Solution
Pas d'affichage		Pas de tension Défaut des fusibles sur l'entrée de secteur.	<ul style="list-style-type: none"> - Vérifier l'alimentation en tension. - Vérifier les fusibles d'entrée du secteur, voir au chapitre "Changer les fusibles d'entrée de secteur". - Interrupteur du secteur sur MARCHE
IMBALANCE		Le rotor est chargé de manière non symétrique.	<ul style="list-style-type: none"> - Ouvrez le couvercle lorsque le rotor est arrêté. - Vérifier le chargement du rotor, voir au chapitre "Chargement du rotor". - Répéter le cycle de centrifugation.
MAINS INTER	11	Interruption du secteur pendant le cycle de centrifugation. (Le cycle de centrifugation n'est pas terminé.)	<ul style="list-style-type: none"> - Ouvrez le couvercle lorsque le rotor est arrêté. - Appuyer sur la touche . - En cas de besoin, répéter le cycle de centrifugation.
MAINS INTERRUPT			
TACHO ERROR	1, 2	Défaillance des impulsions de rotation pendant une opération.	<ul style="list-style-type: none"> - Effectuer une RÉINITIALISATION DU SECTEUR après l'immobilisation du rotor.
LID ERROR	4.1 – 4.127	Erreur du verrouillage ou de la fermeture du capot.	
OVER SPEED	5	Survitesse	
VERSION ERROR	12	Modèle de centrifugeuse détecté incorrect. Défaut / Panne de l'électronique.	<ul style="list-style-type: none"> - Effectuer une RÉINITIALISATION DU SECTEUR après l'immobilisation du rotor.
UNDER SPEED	13	Vitesse trop basse	
CTRL ERROR	22.1, 25.2	Défaut / Panne de l'électronique.	
CRC ERROR	27.1		
COM ERROR	31 – 36		
FC ERROR	60, 61.1 – 61.21, 61.64 – 61.142		
FC ERROR	61.23	Vitesse de rotation mesurée erronée	<ul style="list-style-type: none"> - N'éteignez pas l'appareil tant qu'une rotation est signalée par témoin lumineux . Attendez que le symbole  (couvercle verrouillé) s'affiche (au bout de 120 secondes environ). Exécutez ensuite une RÉINITIALISATION DU SECTEUR.
TACHO ERR	61.22		
FC ERROR	61.153	Défaut / Panne de l'électronique.	<ul style="list-style-type: none"> - Effectuer une RÉINITIALISATION DU SECTEUR. - Vérifier le chargement du rotor, voir au chapitre "Chargement du rotor". - Répéter le cycle de centrifugation.

25 Changer les fusibles d'entrée de secteur



Déclencher l'interrupteur de secteur et couper l'appareil du réseau!

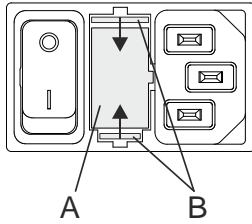

Le porte-fusible (A) avec les fusibles d'entrée de secteur se trouve à côté de l'interrupteur secteur.

- Retirer le câble de raccordement de la prise d'appareil.
- Appuyer la fermeture rapide (B) contre le porte-fusible (A) et extraire celui-ci.
- Remplacer les fusibles d'entrée du réseau défectueux.



N'utilisez que des fusibles avec la valeur nominale, fixée pour le type, voir tableau suivant.

- Remettre en place le porte-fusible et pousser jusqu'à encastrement de la fermeture rapide.
- Rebrancher l'appareil sur le réseau.

Modèle	Type	Fusible	N° de commande
HAEMATOKRIT 200	1801	T 3,15 AH/250V	E997
HAEMATOKRIT 200	1801-01	T 6,3 AH/250V	2266

26 Renvoi d'appareils au fabricant



Avant de renvoyer l'appareil, il faut monter le dispositif de fixation pour le transport.

Dans le cas où l'appareil ou ses accessoires doivent être retournés à la société Andreas Hettich GmbH & Co. KG, il faut les décontaminer et les nettoyer avant expédition, dans le but d'assurer la protection des personnes, de l'environnement et du matériel.

Nous nous réservons le droit de refuser des appareils ou des accessoires contaminés.

Nous facturons au client les frais de nettoyage et de désinfection.

Vous voudrez bien manifester votre compréhension pour cette réglementation.

27 Élimination des déchets

Avant de mettre l'appareil au rebut, vous devez le décontaminer et le nettoyer pour la protection des personnes, de l'environnement et du matériel.

Les dispositions légales en vigueur doivent être respectées lors de l'élimination de l'appareil.

Conformément à la directive 2002/96/CE (WEEE), tous les appareils livrés après le 13.08.2005 ne doivent plus être jetés avec les déchets ménagers. L'appareil fait partie du groupe 8 (dispositifs médicaux) et est classé dans le domaine "Business-to-Business".



Le symbole de la poubelle barrée d'une croix indique que l'appareil ne doit pas être jeté avec les déchets ménagers.

Les dispositions relatives à l'élimination des déchets des différents pays de l'UE peuvent varier. Veuillez-vous adresser en cas de besoin à votre fournisseur.

Indice

1	Impiego di queste istruzioni per l'uso	101
2	Significato dei simboli	101
3	Conformità di impiego	101
4	Rischi residui	101
5	Dati tecnici	102
6	Indicazioni inerenti la sicurezza	103
7	Trasporto ed immagazzinaggio	104
7.1	Trasporto	104
7.2	Immagazzinaggio	104
8	Entità di fornitura.....	104
9	Rimuovere il dispositivo di sicurezza per il trasporto	105
10	Messa in funzione	105
11	Aprire e chiudere il coperchio	106
11.1	Aprire il coperchio	106
11.2	Chiudere il coperchio	106
12	Montaggio e smontaggio del rotore	107
13	Carico del rotore.....	107
14	Elementi di comando e di visualizzazione	108
14.1	Simboli esposti.....	108
14.2	Tasti del campo di comando	108
14.3	Possibilità di regolazione	109
15	Immettere il parametro di centrifugazione	110
15.1	Inoltro diretto del parametro di centrifugazione	110
15.1.1	Regime di rotazione (RPM).....	110
15.1.2	Accelerazione relativa di centrifuga (RCF) e raggio di centrifugazione (RAD).....	110
15.1.3	Tempo di funzionamento	110
15.2	Inoltro del parametro di centrifugazione con il tasto "SELECT"	111
16	Centrifugazione	113
16.1	Centrifugazione con preselezione del tempo	113
16.2	Funzionamento continuo.....	114
16.3	Centrifugazione breve.....	114
17	Arresto di Emergenza.....	115
18	Impostazioni e consultazioni	115
18.1	Consultare informazioni di sistema	116
18.2	Segnale acustico.....	118
18.3	Segnale ottico dopo la fine del processo di centrifugazione	119
18.4	Sbloccaggio automatico del coperchio dopo il processo di centrifugazione.....	120
18.5	Illuminazione di sfondo della videata	121
18.6	Consultazione delle ore di funzionamento e della quantità di processi di centrifugazione	122
18.7	Resetare su zero il contatore cicli	123
19	Accelerazione centrifuga relativa (RCF).....	124
20	Centrifugazione di sostanze o di miscele di sostanze con densità maggiore di 1,2 kg/dm ³	124
21	Determinazione dell'ematocrito	124

21.1	Calcolo del tempo di centrifugazione	124
21.2	Lettura del valore ematocrito.....	124
22	Sbloccaggio di emergenza	125
23	Pulizia e manutenzione	125
23.1	Centrifughe (scatola, coperchio e vano di centrifugazione).....	126
23.1.1	Cura e pulizia delle superfici	126
23.1.2	Disinfezione delle superfici	126
23.1.3	Rimuovere contaminazioni radioattive	126
23.2	Pulizia e disinfezione del rotore ematocrito	126
23.3	Procedimento in caso di provette capillari d'ematocrito rotte	127
23.3.1	Rotori ed accessori con limitata durata di impiego.....	127
24	Guasti.....	128
25	Sostituzione fusibili entrata rete.....	129
26	Rispedizione di apparecchi.....	129
27	Smaltimento	129
28	Anhang / Appendix.....	130
28.1	Rotoren und Zubehör / Rotors and accessories.....	130

1 Impiego di queste istruzioni per l'uso

- Prima della messa in funzione della centrifuga leggere ed osservare le istruzioni per l'uso.
- Le istruzioni per l'uso sono una componente dell'apparecchiatura. Devono essere custodite in modo da essere sempre accessibili.
- Se l'apparecchiatura viene installata in un altro luogo, questa deve venire accompagnata dalle istruzioni per l'uso.

2 Significato dei simboli



Simbolo sull'apparecchio:

Attenzione, punto pericoloso generico.

Prima di utilizzare l'apparecchiatura leggere in ogni caso le istruzioni per l'uso ed osservare le istruzioni rilevanti per la sicurezza!



Symbole sur l'appareil :

respecter le mode d'emploi.

Ce symbole indique que l'utilisateur doit respecter le mode d'emploi mis à disposition.



Simbolo in questo documento.

Attenzione, punto pericoloso generico.

Questo simbolo contraddistingue le avvertenze relative alla sicurezza e indica situazioni potenzialmente pericolose .

La mancata osservanza di tali avvertenze può causare danni materiali e personali.



Simbolo sull'apparecchiatura ed in questo documento:

Attenzione: rischio biologico.



Simbolo in questo documento:

Questo simbolo indica argomenti importanti.



Simbolo sull'apparecchiatura:

Il simbolo si trova sull'alloggiamento, nelle vicinanze della cerniera.

Senso di rotazione del rotore.



Simbolo sull'apparecchiatura:

Il simbolo si trova davanti sull'alloggiamento, al di sotto del foro.

Senso di rotazione della chiave a brugola esagonale per lo sbloccaggio di emergenza del coperchio.



Simbolo sull'apparecchiatura ed in questo documento:

Simbolo per la raccolta separata delle apparecchiature elettriche ed elettroniche, in conformità alle direttive 2002/96/CEE (WEEE). L'apparecchiatura appartiene al gruppo 8 (apparecchiature medicali).

Impiego nelle nazioni dell'Unione Europea, in Norvegia ed in Svizzera.

3 Conformità di impiego

Per quanto riguarda l'apparecchio in oggetto, si tratta di un prodotto medico (centrifuga di laboratorio) ai sensi della direttiva Diagnostici in vitro (IVD) 98/79/CE.

La centrifuga serve per la centrifugazione di campioni di sangue di origine umana nei capillari ematocriti come da norme EN ISO 12772 od in speciali capillari specifici di costruttore per l'analisi quantitativa Buffy Coat.

Le centrifuga è destinata solo a questo scopo d'impiego.

Un diverso od ulteriore tipo di impiego non è regolamentare. La ditta Andreas Hettich GmbH & Co. KG non si prende carico di alcuna responsabilità nel caso di danni da ciò derivanti.

Per l'impiego a norma è previsto anche il rispetto di tutte le avvertenze riportate nelle istruzioni d'uso ed il rispetto degli interventi di ispezione e di manutenzione.

Se la centrifuga viene installata in un'altra apparecchiatura od integrata in un sistema, allora il costruttore del sistema complessivo è responsabile della sicurezza del sistema.

4 Rischi residui

L'apparecchio è costruito secondo lo stato attuale della tecnica e le regole riconosciute riguardanti la tecnica della sicurezza. In caso di uso ed impiego non regolamentari possono insorgere pericoli mortali per l'utilizzatore o per terzi

risp. danni all'apparecchio o ad altri beni materiali. L'apparecchio è destinato solo all'uso regolamentare e va utilizzato solo in uno stato perfetto per quanto riguarda la tecnica della sicurezza.

Eventuali anomalie, che possono pregiudicare la sicurezza devono essere immediatamente eliminate.

5 Dati tecnici

Costruttore	Andreas Hettich GmbH & Co. KG D-78532 Tuttlingen	
Modello	HAEMATOKRIT 200	
Tipo	1801	1801-01
Tensione di rete ($\pm 10\%$)	200 - 240 V 1~	100 - 127 V 1~
Frequenza di rete	50 - 60 Hz-	50 - 60 Hz
Potenza assorbita	270 VA	270 VA
Assorbimento di corrente	1.3 A	2.6 A
Capacità max.	24 x 2.2 ml	
Densità permessa	1.2 kg/dm ³	
Regime di rotazione (RPM)	13000	
Accelerazione (RCF)	16060	
Energia cinetica	950 Nm	
Obbligo di collaudo (BGR 500)	no	
Presupposti ambientali (EN / IEC 61010-1)	<p>solo in interni fino a 2000 metri sopra il livello del mare 2°C fino a 40°C umidità relativa massima dell'aria 80% per temperature fino a 31°C, con riduzione lineare fino al 50% dell'umidità relativa per una temperatura di 40°C.</p>	
– luogo di installazione		
– altezza		
– temperatura ambiente		
– umidità dell'aria		
– Categoria di sovratensione (IEC 60364-4-443)	II	
– grado di imbrattamento	2	
Classe di protezione	I	
non adatto per l'impiego in ambiente a rischio di esplosione.		
Compatibilità elettromagnetica		
– emissione di radiointerferenze resistenza alle interferenze	EN / IEC 61326-1, classe B	FCC Class B
Livello di emissione acustica (in funzione del rotore)	≤ 56 dB(A)	
dimensioni		
– larghezza	261 mm	
– profondità	353 mm	
– altezza	228 mm	
Peso	ca. 10 kg	

6 Indicazioni inerenti la sicurezza



Se non vengono rispettate tutte le avvertenze riportate in queste istruzioni per il funzionamento, non può essere accettata da parte del costruttore alcuna richiesta di garanzia.



- **La centrifuga deve venire posizionata in modo sicuro.**
- **Prima di utilizzare la centrifuga, è necessario controllare che il rotore sia correttamente in sede.**
- **Durante un'operazione di centrifugazione, in una zona di sicurezza di 300 mm attorno alla centrifuga non deve sostare alcuna persona, materiali pericolosi ed oggetti, in conformità alle norme EN / IEC 61010-2-020.**
- **I rotori, le sospensioni e gli accessori che presentano forti segni di corrosione o danni meccanici, oppure la cui durata d'impiego è scaduta, non devono più essere utilizzati.**
- **Se il vano di centrifugazione presenta danni rilevanti per la sicurezza, la centrifuga non deve essere più messa in funzione.**
- **Nel caso di centrifughe senza regolazione termica, con temperature ambiente elevate e/o con frequente impiego dell'apparecchiatura può presentarsi un riscaldamento del vano di centrifugazione. Per questo motivo non può venire esclusa una modificazione del materiale di prova a causa alla temperatura.**

- **Prima di mettere in funzione la centrifuga si devono leggere ed osservare le istruzioni per l'uso. L'apparecchio può essere utilizzato solo da persone che abbiano letto e compreso le istruzioni d'uso.**
- Oltre alle istruzioni per l'uso, si devono osservare anche i regolamenti, relativi alla protezione antinfortunistica ed i regolamenti tecnici, riconosciuti in materia di sicurezza del lavoro. Le istruzioni per l'uso vanno completate dalle norme nazionali in vigore nel paese d'impiego, relative alla protezione antinfortunistica ed alla tutela ambientale.
- La centrifuga è costruita in base all'attuale livello tecnologico e le regole di sicurezza conosciute. La centrifuga può essere tuttavia fonte di pericolo per l'operatore o per terzi, se non viene utilizzata da personale appositamente addestrato o se viene utilizzata in modo improprio o non conforme alla destinazione.
- Durante l'esercizio bisogna evitare di muovere la centrifuga o di urtarvi contro.
- In caso di guasto, ovvero del ripristino d'emergenza, non si deve assolutamente toccare il rotore.
- Quando la centrifuga passa da un ambiente freddo in uno caldo, per evitare danni dovuti alla condensa, lasciar riscaldare la centrifuga per almeno 3 ore nell'ambiente caldo prima di collegarla alla rete, oppure portare la centrifuga a temperatura d'esercizio mettendola in funzione per 30 minuti nell'ambiente freddo.
- E' consentito utilizzare solamente il rotore e gli accessori approvati dalla casa costruttrice per questo apparecchio (vedere capitolo "Anhang/Appendix, Rotoren und Zubehör/Rotors and accessories"). Prima di utilizzare contenitori di centrifugazione, che non sono elencati nel capitolo "Appendice/Appendix, Rotori ed accessori/Rotors and accessories", l'utente deve accertarsi presso il costruttore, che questi possano venire utilizzati.
- Il rotore della centrifuga può essere caricato solo in conformità al capitolo " Carico del rotore".
- In caso di centrifugazione con massimo numero di giri, la densità dei materiali o delle miscele di materiali non deve superare il valore di composizione di $1,2 \text{ kg/dm}^3$.
- Non è consentito l'uso di centrifughe non bilanciate in modo regolamentare.
- Non è permesso l'impiego della centrifuga in ambiente a pericolo di esplosione.
- E' proibito l'uso di una centrifuga con:
 - materiali infiammabili od esplosivi
 - materiali che possono reagire chimicamente tra loro con forte energia.

- Se vengono centrifugate sostanze pericolose o miscele di sostanze contaminate da micro organismi tossici, radioattivi o patogeni, l'utente dovrà prendere opportuni provvedimenti in materia.
Si devono fundamentalmente utilizzare contenitori per centrifugazione con tappi a vite speciali per sostanze pericolose. Con materiali dei gruppi di rischio 3 e 4, oltre ai contenitori per centrifugazione chiudibili si deve impiegare un sistema di sicurezza biologico (vedi manuale "Laboratory Biosafety Manual" dell'Organizzazione mondiale per la salute).
Senza l'impiego di un sistema di sicurezza biologico, una centrifuga non è microbiologicamente a tenuta in conformità alla norma EN / IEC 61010-2-020.
Per questa centrifuga non sono disponibili sistemi di sicurezza biologici.
- Non è consentito il funzionamento della centrifuga con sostanze altamente corrosive che possono pregiudicare la resistenza meccanica dei rotori, delle sospensioni e degli accessori.
- Gli interventi di riparazione devono essere effettuati esclusivamente da una persona autorizzata dal costruttore.
- Devono essere impiegati solo ed esclusivamente pezzi di ricambio originali ed accessori autorizzati della ditta Andreas Hettich GmbH & Co. KG.
- Sono di validità le seguenti norme di sicurezza:
EN / IEC 61010-1 e EN / IEC 61010-2-020 come anche le loro nazionali varianti.
- La sicurezza e l'affidabilità della centrifuga sono garantite solo se:
 - la centrifuga funziona in conformità con le istruzioni per l'uso
 - l'installazione elettrica sul luogo di posizionamento della centrifuga risponde ai requisiti previsti dalla EN / IEC.
- Rientra nelle responsabilità dell'utente il rispetto degli standard specifici nazionali per la sicurezza del lavoro riguardanti l'impiego delle centrifughe di laboratorio ai posti di lavoro da lui previsti.

7 Trasporto ed immagazzinaggio

7.1 Trasporto

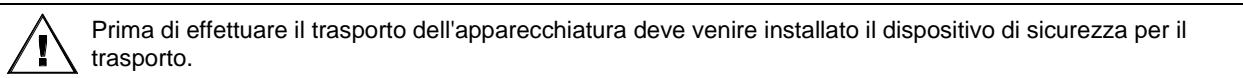

Per il trasporto dell'apparecchiatura e degli accessori devono venire rispettati i seguenti presupposti di ambiente.

- Temperatura ambiente: -20°C fino a +60°C
- Umidità relativa dell'aria: 20% fino a 80%, non condensante

7.2 Immagazzinaggio

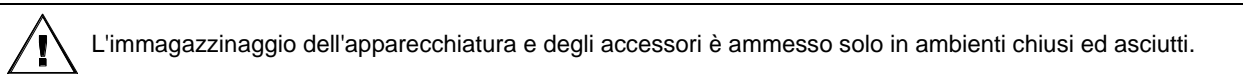

Per l'immagazzinaggio dell'apparecchiatura e degli accessori devono essere rispettati i seguenti presupposti di ambiente.

- Temperatura ambiente: -20°C fino a +60°C
- Umidità relativa dell'aria: 20% fino a 80%, non condensante

8 Entità di fornitura

Con la centrifuga vengono forniti i seguenti accessori:

- 1 cavo di allacciamento
- 2 fusibili
- 1 chiave a brugola esagonale
- 1 Istruzioni per l'uso
- 1 foglio delle istruzioni per il dispositivo di sicurezza per il trasporto
- 1 foglio delle istruzioni per lo sbloccaggio di emergenza

Rotore/i e i corrispondenti accessori vengono forniti in base alla commessa.

9 Rimuovere il dispositivo di sicurezza per il trasporto



Il dispositivo di sicurezza per il trasporto deve venire assolutamente rimosso.

Conservare il dispositivo di sicurezza per il trasporto, poiché prima di un ulteriore trasporto deve venire reinstallato.

Il trasporto dell'apparecchiatura è ammesso solo con dispositivo di sicurezza per il trasporto installato.

Per proteggere l'apparecchiatura durante il trasporto, il motore viene fissato. Questo dispositivo di sicurezza per il trasporto deve venire rimosso al momento della messa in esercizio dell'apparecchiatura.

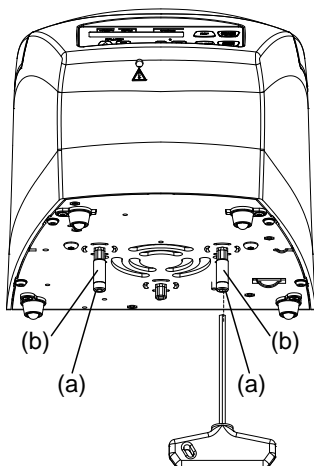

- Rimuovere entrambe le viti (a) e le bussole distanziali (b).



L'installazione del dispositivo di sicurezza per il trasporto avviene nella sequenza inversa.

10 Messa in funzione

- Rimuovere il dispositivo di sicurezza per il trasporto che si trova sul fondo dell'alloggiamento, vedere al capitolo "Rimozione del dispositivo di sicurezza".
- **Porre la centrifuga in un posto adatto e livellarla. Per l'installazione deve essere rispettata la zona di sicurezza di 300 mm attorno alla centrifuga, richiesta in conformità alle norme EN / IEC 61010-2-020**



Durante un'operazione di centrifugazione, in una zona di sicurezza di 300 mm attorno alla centrifuga non deve sostare alcuna persona, materiali pericolosi ed oggetti, in conformità alle norme EN / IEC 61010-2-020.

- Le aperture di ventilazione non devono essere chiuse mettendo oggetti davanti. Rispetto alle feritoie di ventilazione e ad alle aperture di ventilazione della centrifuga deve venir mantenuta una distanza di 300 mm.
- Verificare se la tensione di rete sia adatta all'indicazione riportata nella targhetta con i dati caratteristici.
- Collegare la centrifuga ad una presa di rete standard utilizzando un cavo di rete. Per la potenza massima assorbita, vedere il capitolo "Dati tecnici".
- Inserire l'interruttore di rete (posizione di interruttore "I").
Sul display compare in successione quanto segue:
 1. il modello di centrifuga
 2. il numero del tipo e la versione di programma
 3. i dati di centrifugazione utilizzati da ultimo



Quando il coperchio è chiuso, viene esposto il messaggio "Open the lid".
In questo caso aprire il coperchio, in modo che i dati di centrifugazione vengano esposti.

11 Aprire e chiudere il coperchio

11.1 Aprire il coperchio



Il coperchio si lascia aprire solo, quando la centrifuga è inserita ed il rotore è fermo.
Se ciò non dovesse essere possibile, vedere al capitolo "Sbloccaggio di emergenza".



Quando il contatore cicli è attivato, dopo ogni operazione di centrifugazione e durante l'apertura del coperchio, viene esposta per breve tempo la quantità residua di cicli operativi (operazioni di centrifugazione).

Esempio:



- Premere il tasto.
Il coperchio si sblocca motoricamente.
☐ : Coperchio sbloccato.

Esempio:

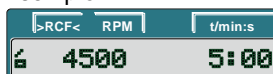

11.2 Chiudere il coperchio



Non intervenire con le dita tra il coperchio e l'alloggiamento.
Non chiudere con violenza il coperchio.

- Adagiare il coperchio e premere leggermente verso il basso il bordo anteriore del coperchio.
Il coperchio si blocca motoricamente.
☐ : Coperchio bloccato.

Esempio:

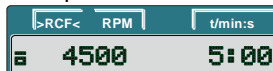

12 Montaggio e smontaggio del rotore

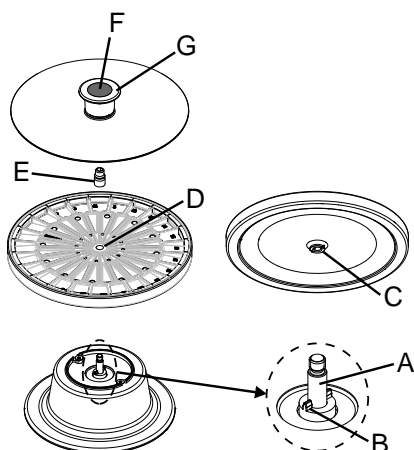

Montaggio:

- Applicare verticalmente il rotore sull'albero motore (A) e premere verso il basso. Il trascinato (B) sull'albero motore deve trovarsi nella scanalatura (C) del rotore. Sul rotore è contrassegnata (D) la direzione della scanalatura.
- Avvitare e serrare con forza il dado di fissaggio (E) con la chiave esagonale che vi è stata fornita, girando in senso orario sull'albero motore (A).



Il dado di fissaggio (E) deve essere sempre ben serrato sull'albero motore (A).

- Controllare che il rotore sia fissato stabilmente.
- Applicare il coperchio sul rotore e premere sulla maniglia verso il basso, fino a quando il coperchio si innesta.

Smontaggio:

- Premere verso il basso il pulsante (F) nella maniglia del coperchio, tirare contemporaneamente verso l'alto l'anello esterno (G) della maniglia e togliere il coperchio dal rotore.
- Svitare e togliere il dado di fissaggio (E) girandolo in senso antiorario con la chiave esagonale che vi è stata fornita.
- Sollevare il rotore dall'albero motore (A).

13 Carico del rotore

- Verificare che il rotore sia fissato.
- Togliere il coperchio dal rotore:
Premere verso il basso il pulsante (F) nella maniglia del coperchio, tirare contemporaneamente verso l'alto l'anello esterno (G) della maniglia e togliere il coperchio dal rotore. Illustrazione vedi capitolo "Montaggio e smontaggio del rotore".
- Il caricamento del rotore è ammesso solo simmetricamente. I recipienti di centrifuga devono essere distribuiti uniformemente su tutti i posti del rotore. Per le combinazioni permesse vedere capitolo "Anhang/Appendix, Rotoren und Zubehör/Rotors and accessories".

Esempio:

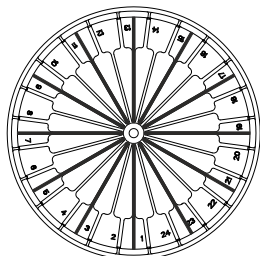

Il rotore è caricato uniformemente

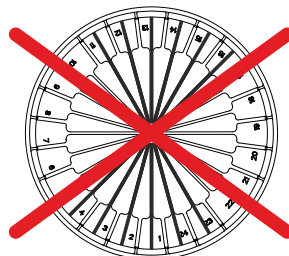

Non ammesso!

Il rotore è caricato in modo non uniforme

- Per la determinazione dell'ematocrito le provette capillari sono riempite sempre al 75 %.
- Con il caricamento del rotore non deve pervenire alcun liquido nel rotore e nel vano di centrifugazione.
- Con l'impiego di tubetti capillari standard, deporli nel rotore con il lato mastice verso l'esterno. Con l'impiego di tubetti capillari autoermetizzanti, questi sono da deporre nel rotore con la parte terminale ermetizzante verso l'esterno.
- Dopo aver caricato il rotore applicare il coperchio sul rotore e premere verso il basso la maniglia fino a quando il coperchio si innesta.

14 Elementi di comando e di visualizzazione

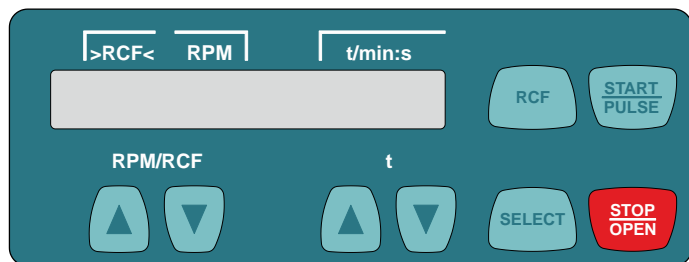

14.1 Simboli esposti



Coperchio sbloccato.



Coperchio bloccato.



Indicazione di rotazione. L'indicazione di rotazione si illumina e ruota senso antiorario, per il tempo in cui il rotore è in rotazione.

14.2 Tasti del campo di comando

RPM/RCF



- Immettere direttamente il regime di rotazione.
- Tenendo premuto il tasto il valore cambia con l'incrementare della velocità.

t



- Immettere direttamente il tempo di funzionamento. Regolabile fino ad 1 minuto in passi di 1 secondo ed a partire da 1 minuto in passi di 1 minuto.
- Immettere il parametro di centrifugazione.
- Tenendo premuto il tasto il valore cambia con l'incrementare della velocità.



- Tasto per la selezione dei singoli parametri. Ad ogni ulteriore pressione del tasto viene selezionato il parametro successivo.
- Richiamare "MACHINE MENU" (tener premuto il tasto per 8 secondi).
- Scegliere nel "Machine Menu" i menu "→ Info", "→ Settings" e "→ Time & Cycles".
- Sfogliare in avanti nei menu.



- Commutazione tra l'indicazione RPM (RPM) e l'indicazione RCF (>RCF<). I valori RCF vengono indicati tra parentesi ><.
- RPM: Regime di rotazione
- RCF : Accelerazione relativa di centrifuga



- Avviare il processo di centrifugazione.
- Centrifugazione breve. Il processo di centrifugazione avviene, per il tempo in cui il tasto viene premuto.
- Richiamare i menu "→ Info", "→ Settings" e "→ Time & Cycles".



- Terminare il processo di centrifugazione. Il rotore rallenta con il livello di frenata preselezionato. Una doppia pressione del tasto sgancia l'Arresto di Emergenza.
- Sbloccare il coperchio.

14.3 Possibilità di regolazione

t/min **Tempo di funzionamento.** Regolabile da 1 - 99 min, in passi di 1 minuto.

t/sec **Tempo di funzionamento.** Regolabile da 1 - 59 s, in passi di 1 secondo.

Funzionamento continuo "--:--". Impostare il parametro **t/min** e **t/sec** su zero.

RPM **Regime di rotazione**

Può essere impostato un valore numerico di 200 RPM fino al regime massimo di rotazione del rotore. Impostabile da 200 RPM fino a 10000 RPM in passi da 10 ed oltre i 10000 RPM in passi da 100. Per il regime massimo di rotazione del rotore vedere al capitolo "Appendice/Appendix, Rotori ed accessori/Rotors and accessories".

>RCF< **Accelerazione relativa di centrifuga**

Può essere impostato un valore numerico, con il quale si ottiene un regime di rotazione tra 200 RPM ed il massimale regime di rotazione del rotore. Impostabile fino a 10000 in passi di 1 ed oltre i 10000 in passi di 10.



L'inoltro della accelerazione relativa di centrifuga (RCF) è possibile solo, se viene scelta l'indicazione RCF (>RCF<).

L'accelerazione relativa di centrifuga (RCF) dipende dal raggio di centrifugazione (RAD). Dopo l'inoltro di RCF verificare, che sia impostato l'esatto raggio di centrifugazione.

RAD/mm **Raggio di centrifugazione**

Impostabile da 10 mm fino a 250 mm, in passi di 1 millimetro.

Per il raggio di centrifugazione vedere al capitolo "Appendice/Appendix, Rotori ed accessori/Rotors and accessories".







L'inoltro del raggio di centrifugazione è possibile solo, se viene scelta l'indicazione RCF (>RCF<).

~\DEC **Livello di frenata.** **fast** = arresto in breve tempo, **slow** = arresto in tempo lungo.

15 Immettere il parametro di centrifugazione

15.1 Inoltro diretto del parametro di centrifugazione

Il regime di rotazione (RPM), la accelerazione relativa di centrifuga (RCF), il raggio di centrifugazione (RAD) ed il tempo di funzionamento possono venire immessi direttamente con i tasti  , senza dover premere in precedenza il tasto .

 I parametri di centrifugazione impostati vengono memorizzati solo dopo l'avvio del processo di centrifugazione.

15.1.1 Regime di rotazione (RPM)

Esempio:



- In caso di necessità premere il tasto per selezionare l'indicazione RPM (RPM).



- Scegliere con i tasti il valore desiderato.

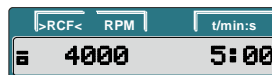

15.1.2 Accelerazione relativa di centrifuga (RCF) e raggio di centrifugazione (RAD)

Esempio:



- In caso di necessità premere il tasto per selezionare l'indicazione RCF (>RCF<).

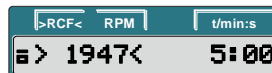

- Scegliere con i tasti il valore RCF desiderato.



- In caso di necessità impostare con i tasti il raggio di centrifugazione desiderato.



15.1.3 Tempo di funzionamento

 Il tempo di funzionamento può venire impostato fino ad 1 minuto in passi di 1 secondo ed a partire da 1 minuto solo in passi di un minuto.

Per impostare il funzionamento continuo, i parametri **t/min** e **t/sec** devono venir impostati su zero. Sull'indicatore del tempo (t/min:s) compare "---:--".

Esempio:



Esempio:



- Scegliere con i tasti il valore desiderato.

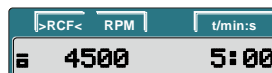

15.2 Inoltro del parametro di centrifugazione con il tasto "SELECT"



Il tempo di funzionamento può venire impostato in minuti ed in secondi (parametri **t/min** e **t/sec**).

Per impostare il funzionamento continuo, i parametri **t/min** e **t/sec** devono venir impostati su zero. Nell'indicatore del tempo (t/min:s) compare "--:--".

Esempio:





L'accelerazione relativa di centrifuga (RCF) dipende dal raggio di centrifugazione (RAD).

Durante l'inoltro dell'RCF viene esposto il raggio di centrifugazione impostato.

Se dopo la selezione o durante l'inoltro dei parametri, per otto secondi di tempo non viene premuto alcun tasto, sul display vengono esposti di nuovo di valori precedenti. L'inoltro dei parametri deve poi venire eseguito nuovamente.



















Premendo il tasto  vengono memorizzate le impostazioni.

Con l'inoltro di più parametri, il tasto  deve venir premuto solo dopo l'impostazione dell'ultimo parametro.

L'inoltro dei parametri può sempre venire interrotto premendo il tasto . In questo caso le impostazioni non vengono memorizzate.



Prosegua alla pagina successiva

	<ul style="list-style-type: none"> • Premere il tasto. RPM : Regime di rotazione. RAD/mm : Raggio di centrifugazione. La visualizzazione e l'inoltro del raggio di centrifugazione è possibile solo, se viene scelta l'indicazione RCF (>RCF<). 	Esempio: Indicazione RPM (RPM)		Esempio: Indicazione RCF (>RCF<)	
	<ul style="list-style-type: none"> • Scegliere con i tasti il valore desiderato. 				
	<ul style="list-style-type: none"> • Premere il tasto. R : Raggio di centrifugazione. RCF : Accelerazione relativa di centrifuga. 				
	<ul style="list-style-type: none"> • Scegliere con i tasti il valore desiderato. 				
	<ul style="list-style-type: none"> • Premere il tasto . _DEC : Livello di frenata. fast : arresto in breve tempo. slow : arresto in tempo lungo. 				
	<ul style="list-style-type: none"> • Scegliere con i tasti il valore desiderato. 				
	<ul style="list-style-type: none"> • Premere il tasto per memorizzare l'impostazione. 				

16 Centrifugazione



Durante un processo di centrifugazione, come da norme EN / IEC 61010-2-020 non deve trovarsi alcuna persona, prodotti pericolosi ed oggetti in un settore di sicurezza di 300 mm attorno alla centrifuga.



Se con il caricamento del rotore è stata superata la differenza di peso ammessa, il processo di centrifugazione viene interrotto durante l'avvio e compare la seguente videata:



Un processo di centrifugazione può sempre venire interrotto premendo il tasto .

Durante un processo di centrifugazione i parametri di centrifugazione possono venire selezionati e modificati. I valori modificati sono validi però solo per l'attuale processo di centrifugazione e non vengono memorizzati.

Con il tasto  può avvenire in qualsiasi momento la commutazione tra l'indicazione RPM (RPM) e l'indicazione RCF (>RCF<). Se il lavoro avviene con l'indicazione RCF (>RCF<) è necessario l'inoltro del raggio di centrifugazione.

Viene esposto quanto segue



un ulteriore intervento operativo alla centrifuga è possibile solo dopo l'apertura del coperchio.

Gli errori operativi e le anomalie vengono esposti (vedere il capitolo "Anomalie").

- Inserire l'interruttore di rete. Posizione dell'interruttore I.
- Caricare il rotore e chiudere il coperchio della centrifuga.

16.1 Centrifugazione con preselezione del tempo



- In caso di necessità premere il tasto, per selezionare l'indicazione RPM (RPM) oppure l'indicazione RCF (>RCF<).





- Immettere il parametro di centrifugazione desiderato (vedere al capitolo "Immettere il parametro di centrifugazione").



- Premere il tasto, per avviare il processo di centrifugazione.

Durante il processo di centrifugazione vengono esposti il regime di rotazione del rotore od il valore RCF che ne risulta e il tempo residuo.



- Una volta decorso il tempo o dopo l'interruzione del processo di centrifugazione premendo il tasto , avviene l'arresto con il livello di frenate impostato. Viene esposto il livello di frenata. Esempio 



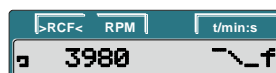
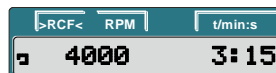
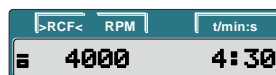
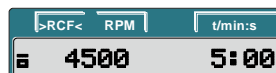



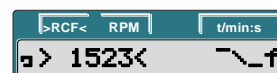
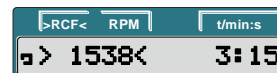
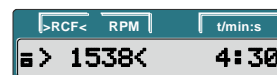





Esempio: Indicazione RPM (RPM)



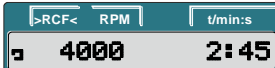











Esempio: Indicazione RCF (>RCF<)



16.2 Funzionamento continuo

<p></p> <p>↓</p> <ul style="list-style-type: none"> • In caso di necessità premere il tasto, per selezionare l'indicazione RPM (RPM) oppure l'indicazione RCF (>RCF<). <p>↓</p> <ul style="list-style-type: none"> • Immettere il parametro di centrifugazione desiderato. Impostare i parametri t/min e t/sec su zero (vedere al capitolo "Immettere il parametro di centrifugazione"). <p>↓</p> <p></p> <ul style="list-style-type: none"> • Premere il tasto, per avviare il processo di centrifugazione. Durante il processo di centrifugazione vengono esposti il regime di rotazione del rotore od il valore RCF che ne risulta e il tempo decorso. <p>↓</p> <p></p> <ul style="list-style-type: none"> • Premere il tasto, per terminare il processo di centrifugazione . L'arresto avviene con il livello di frenata impostato. Viene esposto il livello di frenata. Esempio  	<p>Esempio: Indicazione RPM (RPM)</p>    	<p>Esempio: Indicazione RCF (>RCF<)</p>    
--	---	---

16.3 Centrifugazione breve

<p></p> <p>↓</p> <ul style="list-style-type: none"> • In caso di necessità premere il tasto, per selezionare l'indicazione RPM (RPM) oppure l'indicazione RCF (>RCF<). <p>↓</p> <ul style="list-style-type: none"> • Immettere il parametro di centrifugazione desiderato (vedere al capitolo "Immettere il parametro di centrifugazione"). <p>↓</p> <p></p> <ul style="list-style-type: none"> • Premere il tasto e tenerlo premuto. Durante il processo di centrifugazione vengono esposti il regime di rotazione del rotore od il valore RCF che ne risulta e il tempo decorso. <p>↓</p> <p></p> <ul style="list-style-type: none"> • Abbandonare il tasto per terminare il processo di centrifugazione. L'arresto avviene con il livello di frenata impostato. Viene esposto il livello di frenata. Esempio  	<p>Esempio: Indicazione RPM (RPM)</p>    	<p>Esempio: Indicazione RCF (>RCF<)</p>    
--	---	---

17 Arresto di Emergenza



- Premere due volte il tasto.
Con l'arresto di emergenza, l'arresto avviene con il livello di frenata "fast" (arresto in breve tempo). Viene esposto il livello di frenata \sim f.

Esempio: Indicazione RPM (RPM)

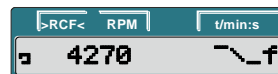

Esempio: Indicazione RCF (>RCF<)



18 Impostazioni e consultazioni

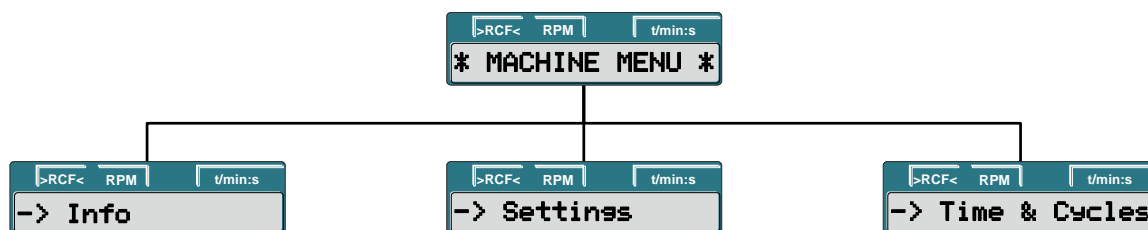

Consultazione:

- Informazioni di sistema

Impostazione:

- Segnale acustico
- Sbloccaggio automatico del coperchio dopo il processo di centrifugazione
- Disinserimento automatico dell'illuminazione di sfondo
- Segnale ottico dopo la fine del processo di centrifugazione

Consultazione:



- Ore di esercizio
- Quantità di processi di centrifugazione eseguiti

18.1 Consultare informazioni di sistema

Possono venir consultate le seguenti informazioni di sistema:

- Modello dell'apparecchiatura,
- Versione del programma dell'apparecchiatura,
- Numero del tipo di apparecchiatura,
- Data di produzione dell'apparecchiatura,
- Numero di serie dell'apparecchiatura,
- Tipo di convertitore di frequenza,
- Versione di programma del convertitore di frequenza

La consultazione può essere eseguita, durante l'arresto del rotore, come segue:

 Il processo può sempre venire interrotto premendo il tasto .



- Tenere premuto il tasto 8 secondi.



- Premere il tasto.



- Premere il tasto.
Modello dell'apparecchiatura



- Premere il tasto.
Versione del programma dell'apparecchiatura.

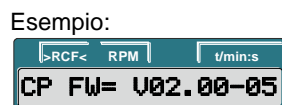

- Premere il tasto.
Type#1 : Numero del tipo di apparecchiatura

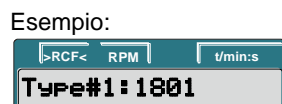

- Premere il tasto.
Type#2 : Prosecuzione del numero del tipo, se questi ha più posizioni del campo di videata "**Type#1**".



- Premere il tasto.
Data di produzione dell'apparecchiatura.

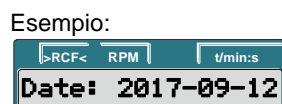

Prosegue alla pagina successiva



- Premere il tasto..
Numero di serie dell'apparecchiatura.

Esempio:

>RCF<	RPM	t/min:s
Serial#: 0016234		



- Premere il tasto .
Tipo di convertitore di frequenza.

Esempio:

>RCF<	RPM	t/min:s
FC type LC 300VA		



- Premere il tasto .
Versione di programma del convertitore di frequenza.

Esempio:

>RCF<	RPM	t/min:s
FC FW= D 1.04		



- Premere due volte il tasto, per abbandonare il menu "→ Info" o premere tre volte, per abbandonare il menu "* MACHINE MENU *".

Esempio:

>RCF<	RPM	t/min:s
* MACHINE MENU *		

>RCF<	RPM	t/min:s
4500	5:00	



18.2 Segnale acustico

Suona il segnale acustico:

- dopo che si è presentata un'anomalia, in intervalli di 2 s.
- dopo che è terminato il processo di centrifugazione e con l'arresto del rotore, in intervalli di 30 s.

Il segnale acustico viene disinserito premendo un tasto piacere.

Il segnale acustico può essere impostato, durante l'arresto del rotore, come segue:

 Il processo può sempre venire interrotto premendo il tasto . In questo caso le impostazioni non vengono memorizzate.

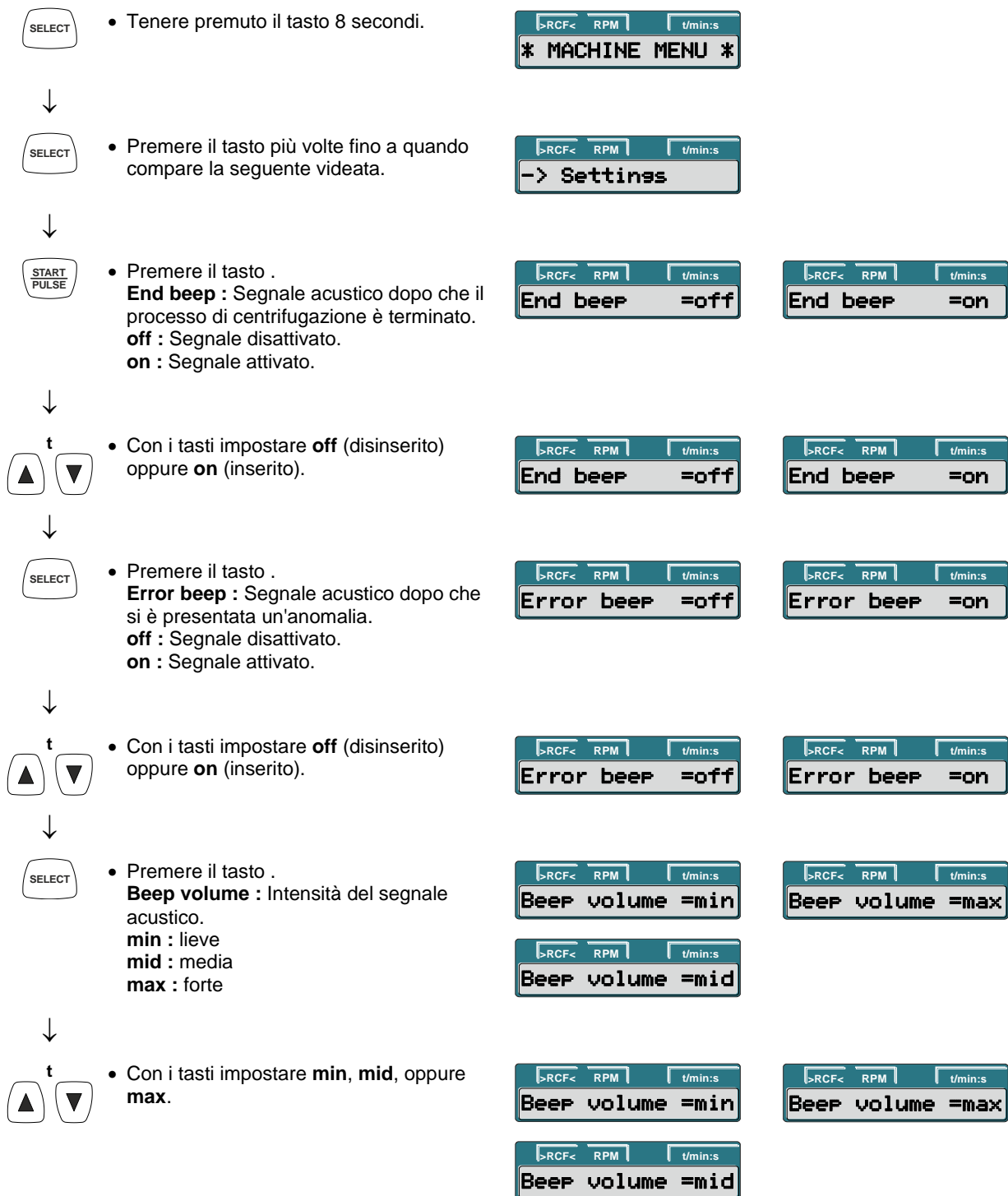

Prosegue alla pagina successiva



- Premere il tasto per memorizzare l'impostazione.

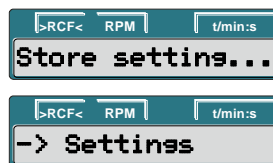

- Premere una volta il tasto, per abbandonare il menu "-> Settings" oppure prendere due volte, per abbandonare il menu "* MACHINE MENU *".



Esempio:



18.3 Segnale ottico dopo la fine del processo di centrifugazione

La illuminazione di sfondo della videata lampeggia dopo il processo di centrifugazione, per segnalare otticamente che il processo di centrifugazione è terminato.

Il segnale ottico può essere inserito o disinserito, durante l'arresto del rotore, come segue:

Il processo può sempre venire interrotto premendo il tasto .



- Tenere premuto il tasto 8 secondi.



- Premere il tasto più volte fino a quando compare la successiva videata.



- Premere il tasto .



- Premere più volte il tasto fino a quando compare una delle due videate.
End blinking : Lampeggio della illuminazione di sfondo della videata dopo il processo di centrifugazione.
off : La illuminazione di sfondo non lampeggia.
on : La illuminazione di sfondo lampeggia.



- Con i tasti impostare **off** (disinserito) oppure **on** (inserito).



- Premere il tasto per memorizzare l'impostazione.

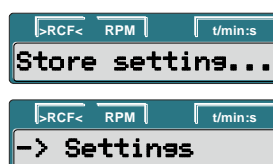

- Premere una volta il tasto, per abbandonare il menu "-> Settings" oppure prendere due volte, per abbandonare il menu "* MACHINE MENU *".



Esempio:

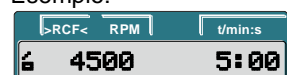





















18.4 Sbloccaggio automatico del coperchio dopo il processo di centrifugazione

Può avvenire l'impostazione, se dopo il processo di centrifugazione il coperchio si sblocca o meno.

Ciò può venire impostato, durante l'arresto del rotore, come segue:





Il processo può sempre venire interrotto premendo il tasto . In questo caso le impostazioni non vengono memorizzate.



















	<ul style="list-style-type: none"> • Tenere premuto il tasto 8 secondi. 		
↓			
	<ul style="list-style-type: none"> • Premere il tasto più volte fino a quando compare la successiva videata. 		
↓			
	<ul style="list-style-type: none"> • Premere il tasto . 		
↓			
	<ul style="list-style-type: none"> • Premere più volte il tasto fino a quando compare una delle due videate. Lid AutoOpen : Sbloccaggio automatico del coperchio dopo il processo di centrifugazione. off : Il coperchio non si sblocca automaticamente. on : Il coperchio si sblocca automaticamente. 		
↓			
	<ul style="list-style-type: none"> • Con i tasti impostare off oppure on. 		
↓			
	<ul style="list-style-type: none"> • Premere il tasto per memorizzare l'impostazione. 		
			
↓			
	<ul style="list-style-type: none"> • Premere una volta il tasto, per abbandonare il menu "-> Settings" oppure prendere due volte, per abbandonare il menu "* MACHINE MENU *". 		<p>Esempio:</p> 

18.5 Illuminazione di sfondo della videata

Per risparmiare energia può venire impostato, che dopo un processo di centrifugazione l'illuminazione di sfondo della videata si spenga dopo due minuti.

Ciò può venire impostato, durante l'arresto del rotore, come segue:

 Il processo può sempre venire interrotto premendo il tasto . In questo caso le impostazioni non vengono memorizzate.

	<ul style="list-style-type: none"> • Tenere premuto il tasto 8 secondi. 		
↓			
	<ul style="list-style-type: none"> • Premere il tasto più volte fino a quando compare la seguente videata: 		
↓			
	<ul style="list-style-type: none"> • Premere il tasto . 		
↓			
	<ul style="list-style-type: none"> • Premere più volte il tasto fino a quando compare una delle due videate. Power save : Disinserimento automatico dell'illuminazione di sfondo. off : Disinserimento automatico disattivato. on : Disinserimento automatico attivato. 		
↓			
	<ul style="list-style-type: none"> • Con i tasti impostare off (disinserito) oppure on (inserito). 		
↓			
	<ul style="list-style-type: none"> • Premere il tasto per memorizzare l'impostazione. 		
↓			
↓			
	<ul style="list-style-type: none"> • Premere una volta il tasto, per abbandonare il menu "-> Settings" oppure prendere due volte, per abbandonare il menu "* MACHINE MENU *". 		<p>Esempio:</p> 



18.6 Consultazione delle ore di funzionamento e della quantità di processi di centrifugazione

Le ore di funzionamento sono suddivise in ore di funzionamento interne ed esterne.

Ore di funzionamento interne: Tempo complessivo, nel quale l'apparecchiatura era inserita.

Ore di funzionamento esterne: Tempo complessivo dei processi di centrifugazione avvenuti fino ad ora.

La consultazione può essere eseguita, durante l'arresto del rotore, come segue:

 Il processo può sempre venire interrotto premendo il tasto .

SELECT

- Tenere premuto il tasto 8 secondi.

 >RCF< RPM t/min:s
 * MACHINE MENU *



SELECT

- Premere il tasto più volte fino a quando compare la successiva videata.

 >RCF< RPM t/min:s
 -> Time & Cycles



START PULSE

- Premere il tasto .
TimeExt : Ore di funzionamento esterne.

Esempio:

 >RCF< RPM t/min:s
 TimeExt= 43 h



SELECT

- Premere il tasto .
TimeInt : Ore di funzionamento interne.

Esempio:

 >RCF< RPM t/min:s
 TimeInt= 60 h



SELECT

- Premere il tasto .
Starts : Quantità di tutti i processi di centrifugazione.

Esempio:

 >RCF< RPM t/min:s
 Starts= 325



STOP OPEN

- Premere due volte il tasto, per abbandonare il menu "-> Time & Cycles" o premere tre volte, per abbandonare il menu "* MACHINE MENU *".

Esempio:



 >RCF< RPM t/min:s
 * MACHINE MENU *
 4500 5:00

18.7 Resettare su zero il contatore cicli

Dopo che il rotore è stato sostituito, il contatore cicli deve venir resettato su zero.

 Il resettaggio su zero del contatore cicli è ammesso solo, se il rotore è stato sostituito in precedenza con un rotore nuovo.

Il resettaggio del contatore cicli può essere eseguito, durante l'arresto del rotore, come segue:

 Il processo può sempre venire interrotto premendo il tasto . In questo caso le impostazioni non vengono memorizzate.



- Tenere premuto il tasto 8 secondi.

```
>RCF< RPM t/min:s
* MACHINE MENU *
```



- Premere il tasto più volte fino a quando compare la seguente videata:

```
>RCF< RPM t/min:s
-> Time & Cycles
```



- Premere il tasto .

Esempio:

```
>RCF< RPM t/min:s
TimeExt= 43 h
```



- Premere il tasto più volte fino a quando compare la seguente videata:
Cyc sum : Quantità di cicli operativi eseguiti.

```
>RCF< RPM t/min:s
Cyc sum= 50001
```



- Premere il tasto .

```
>RCF< RPM t/min:s
Cyc sum=< 50001>
```



- Premere il tasto .
La quantità di cicli operativi eseguiti viene resettata su zero.

```
>RCF< RPM t/min:s
Cyc sum=< 0>
```



- Premere il tasto per memorizzare l'impostazione.

```
>RCF< RPM t/min:s
Store cycles ...
```

```
>RCF< RPM t/min:s
Cyc sum= 0
```



- Premere due volte il tasto, per abbandonare il menu "**-> Time & Cycles**" o premere tre volte, per abbandonare il menu "*** MACHINE MENU ***".

```
>RCF< RPM t/min:s
* MACHINE MENU *
```

Esempio:

```
>RCF< RPM t/min:s
4500 5:00
```

19 Accelerazione centrifuga relativa (RCF)

L'accelerazione centrifuga relativa (RCF) è indicata come un multiplo dell'accelerazione terrestre (g). È un valore numerico privo di unità e funge per paragonare le prestazioni di separazione e sedimentazione.

Il calcolo viene eseguito in base alla formula:

$$RCF = \left(\frac{RPM}{1000} \right)^2 \times r \times 1,118 \quad \Rightarrow \quad RPM = \sqrt{\frac{RCF}{r \times 1,118}} \times 1000$$

RCF = accelerazione centrifuga relativa

RPM = numero dei giri

r = raggio di centrifugazione in mm = distanza dal centro dell'asse di rotazione fino al fondo del recipiente di centrifugazione. Raggio di centrifugazione vedi al capitolo "Anhang/Appendix, Rotoren und Zubehör/Rotors and accessories".



L'accelerazione centrifuga relativa (RCF) dipende dal numero dei giri e dal raggio di centrifugazione.

20 Centrifugazione di sostanze o di miscele di sostanze con densità maggiore di 1,2 kg/dm³

In caso di centrifugazione con massimo numero di giri, la densità dei materiali o delle miscele di materiali non deve superare il valore di composizione di 1,2 kg/dm³.

Con sostanze o miscele di sostanze di densità maggiore, il regime di rotazione deve venire ridotto.

Il numero di giri consentito si calcola con la formula seguente:

$$\text{numero di giri ridotto (n}_{\text{red}}) = \sqrt{\frac{1,2}{\text{densità maggiore [kg/dm}^3]}} \times \text{regime massimo di rotazione [RPM]}$$

p.es.: regime massimo di rotazione RPM 4000, densità 1,6 kg/dm³

$$n_{\text{red}} = \sqrt{\frac{1,2 \text{ kg/dm}^3}{1,6 \text{ kg/dm}^3}} \times 4000 \text{ RPM} = 3464 \text{ RPM}$$

In caso di dubbio, rivolgersi al costruttore per maggiori informazioni.

21 Determinazione dell'ematocrito

21.1 Calcolo del tempo di centrifugazione

Per il calcolo del tempo di centrifugazione vale la seguente formula approssimativa:

$$\frac{100000}{RCF} = \text{Tempo di centrifugazione in minuti}$$

RCF = Relativa accelerazione centrifugale

Per il calcolo di RCF vedere al capitolo "Relativa accelerazione centrifugale (RCF)".

Esempio:

RCF = 16060

$$\frac{100000}{16060} = 6,23 \text{ minuti} = 6 \text{ minuti e } 14 \text{ secondi}$$

Con un RCF di 16060 il tempo di centrifugazione è di 6 minuti e 14 secondi.

21.2 Lettura del valore ematocrito

La lettura del valore ematocrito viene eseguita nel modo seguente:

- Tener fermo il rotore.
- Girare il disco di lettura (coperchio del rotore), fino a quando la linea di 100% del disco di lettura corrisponda con il bordo superiore della colonna di liquido nel tubetto capillare.
- Leggere, sul bordo superiore della colonna degli eritrociti, il valore ematocrito.

Ripetere il procedimento fino a quando tutti i tubetti capillari sono stati valutati.

22 Sbloccaggio di emergenza

Nel caso di uscita di servizio della corrente il coperchio non può venire sbloccato motoricamente. Deve essere eseguito uno sbloccaggio di emergenza di tipo manuale.



Per lo sbloccaggio di emergenza staccare la centrifuga dalla rete di alimentazione.
Aprire il coperchio solo a rotore fermo.



ATTENZIONE! Danneggiamento della chiusura, durante lo sbloccaggio di emergenza, quando la chiave a forchetta esagonale viene girata in senso orario (verso destra).

La rotazione della chiave a forchetta esagonale è ammessa solo in senso antiorario (verso sinistra), vedere illustrazione.

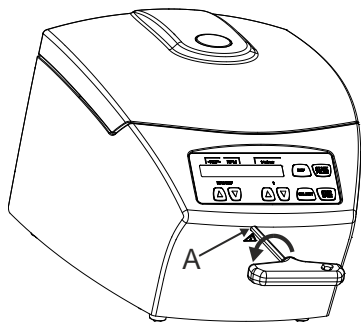

- Disinserire l'interruttore di rete (posizione di interruttore "0").
- Guardare dalla finestra che si trova sul coperchio per assicurarsi che il rotore sia fermo.
- Introdurre orizzontalmente nel foro (A) la chiave a forchetta esagonale e girare con cautela in senso antiorario (verso sinistra), fino a quando il coperchio si apre.
- Estrarre poi la chiave a forchetta esagonale dal foro.

23 Pulizia e manutenzione



L'apparecchiatura può essere contaminata.



Prima della pulizia, staccare la presa di corrente.

Prima di iniziare un procedimento di pulizia e decontaminazione diverso da quello consigliato dal produttore, l'utilizzatore deve accertarsi presso il produttore che tale procedimento previsto non rechi danno all'apparecchio.

- Centrifughe, rotori e accessori non devono essere lavati in lavastoviglie.
- Si deve eseguire solo una pulizia manuale ed una disinfezione con liquido.
- La temperatura dell'acqua deve essere di 20 – 25°C.
- Devono essere utilizzati solo detersivi o disinfettanti che:
 - abbiano un campo di valori del pH che va da 5 a 8,
 - non contengano alcali caustici, perossidi, composti di cloro, acidi e soluzioni alcaline.
- Seguire attentamente le indicazioni speciali del produttore sull'impiego di detersivi e disinfettanti, al fine di evitare qualsiasi fenomeno di corrosione.



Il rotore ematocrito, il coperchio rotore, le bacinelle imbottite e gli anelli di tenuta non possono essere trattati in autoclave.

23.1 Centrifughe (scatola, coperchio e vano di centrifugazione)

23.1.1 Cura e pulizia delle superfici

- Pulire regolarmente il corpo della centrifuga e la camera di centrifugazione e impiegare all'occorrenza sapone o un detergente delicato e un panno umido. Ciò serve da un lato per l'igiene e dall'altro lato per evitare la corrosione causata da impurità incrostate.
- Ingredienti dei detergenti adatti:
sapone, tensidi anionici, tensidi non ionici.
- Dopo l'impiego di detergenti, rimuovere i resti del detergente pulendo di nuovo con un panno umido.
- Le superfici devono essere asciugate subito dopo la pulizia.
- In caso di formazione di acqua di condensa, asciugare la camera di centrifugazione pulendola con un panno assorbente.
- Spalmare sulla guarnizione di gomma della camera di centrifugazione, frizionando leggermente, polvere di talco o una sostanza per la cura della gomma.
- Controllare una volta l'anno se il vano di centrifugazione presenta danneggiamenti.



Se vengono stabiliti danni rilevanti per la sicurezza, la centrifuga non deve essere più messa in funzione. In questo caso si deve contattare il servizio assistenza clienti.

23.1.2 Disinfezione delle superfici

- In presenza di materiale infettivo nella camera di centrifugazione si deve disinfettarla immediatamente.
- Ingredienti dei disinfettanti adatti:
etanolo, alcol n proclitico, etilexanolo, tensidi anionici, inibitori di corrosione.
- Dopo l'impiego di disinfettanti, rimuovere i resti del disinfettante pulendo di nuovo con un panno umido.
- Le superfici devono essere asciugate subito dopo la disinfezione.

23.1.3 Rimuovere contaminazioni radioattive

- La sostanza deve essere certificata in modo speciale per rimuovere contaminazioni radioattive.
- Ingredienti di sostanze adatte alla rimozione di contaminazioni radioattive:
tensidi anionici, tensidi non ionici, etanolo poliidratato.
- Dopo aver rimosso le contaminazioni radioattive, rimuovere i resti della sostanza pulendo di nuovo con un panno umido.
- Le superfici devono essere asciugate, subito dopo la rimozione delle contaminazioni radioattive.

23.2 Pulizia e disinfezione del rotore ematocrito

Se, nonostante tutte le misure di cautela, durante la centrifugazione dovessero fuoriuscire delle provette capillari d'ematocrito, devono essere puliti il rotore e il coperchio. Procedere quanto segue:

- Estrarre con cautela le bacinelle imbottite o l'anello di tenuta dal rotore ematocrito.
- Immergere nell'acqua fredda il rotore ematocrito, il coperchio nonché la bacinella imbottita o l'anello di tenuta finché i residui di sangue non si fossero sciolti completamente.
- Eseguire una disinfezione idonea. Se possibile non utilizzare disinfettanti sul coperchio per non danneggiare la stampa.
Ingredienti dei disinfettanti adatti: glutaraldeide, propanolo, etilexanolo, tensidi anionici, inibitori di corrosione.
Ingredienti di sostanze adatte alla rimozione di contaminazioni radioattive: tensidi anionici, tensidi non ionici, etanolo poliidratato.
- Sciacquare in acqua fredda e asciugare i componenti.
- Ora reinserirli nella centrifuga.

23.3 Procedimento in caso di provette capillari d'ematocrito rotte



Pericolo di ferimento!

Si consiglia di lavorare con due paia di guanti. Per proteggersi dai frammenti di vetro eventualmente in proiezione, portare gli occhiali di sicurezza e la protezione per la bocca!

- Togliere con cautela il coperchio del rotore d'ematocrito.
- Eliminare i frammenti maggiori delle provette capillari aiutandosi con una pinzetta.
- Estrarre il rotore. Con una pinzetta estrarre con cautela e lentamente le bacinelle imbottite concernenti o l'anello di tenuta e sostituirli.
- Pulizia e disinfezione come descritte sopra.

23.3.1 Rotori ed accessori con limitata durata di impiego

L'impiego del rotore, codice d'ordine N° 2076, ha un limite di tempo.

La data di scadenza è applicata sul rotore, per esempio: "einsetzbar bis Ende: IV. Quartal 2019 / usable until end of: IV. Quartal 2019" (utilizzabile fino alla fine: IV. trimestre 2019).







Per ragioni di sicurezza l'impiego del rotore non è più ammesso, quando la contrassegnata data di scadenza è raggiunta.

24 Guasti

Se non si riesce a eliminare l'errore seguendo le indicazioni della tabella guasti, informare il servizio assistenza clienti.

Si prega di indicare il tipo di centrifuga e il numero di serie. Entrambi i numeri sono visibili sulla targhetta di modello della centrifuga.

-  Esecuzione di un RESET RETE:
- Disinserire l'interruttore di rete (posizione interruttore "0").
 - Attendere almeno 10 secondi quindi reinserire l'interruttore di rete (posizione interruttore "1").

Visualizzazione/guasto		Causa	Eliminazione
Nessun indicatore		Assenza di tensione Scatto del fusibile di sicurezza per sovracorrente.	<ul style="list-style-type: none"> - Controllare la tensione di alimentazione. - Controllare i fusibili di ingresso di rete, vedere il capitolo "Sostituzione fusibili entrata rete". - Interruttore generale ACCESO.
IMBALANCE		Il rotore è caricato in modo non uniforme.	<ul style="list-style-type: none"> - Aprire il coperchio dopo che il rotore si è fermato. - Controllare il caricamento del rotore, vedere il capitolo "Carico del rotore". - Ripetere il ciclo di centrifugazione.
MAINS INTER	11	Interruzione di rete durante il ciclo di centrifugazione. (Il ciclo di centrifugazione non viene terminato.)	<ul style="list-style-type: none"> - Aprire il coperchio dopo che il rotore si è fermato. - Premere tasto . - All'occorrenza ripetere il ciclo di centrifugazione.
MAINS INTERRUPT			
TACHO ERROR	1, 2	Mancanza degli impulsi del numero di giri durante il funzionamento.	<ul style="list-style-type: none"> - Dopo l'arresto del rotore eseguire un RESET RETE.
LID ERROR	4.1 – 4.127	Errore blocco coperchio, ovvero chiusura coperchio.	
OVER SPEED	5	N° giri eccedente	
VERSION ERROR	12	Riconosciuto un modello di centrifuga sbagliato. Guasto/difetto sistema elettronico.	<ul style="list-style-type: none"> - Dopo l'arresto del rotore eseguire un RESET RETE.
UNDER SPEED	13	N° giri insufficiente	
CTRL ERROR	22.1, 25.2	Guasto/difetto sistema elettronico.	
CRC ERROR	27.1		
COM ERROR	31 – 36		
FC ERROR	60, 61.1 – 61.21, 61.64 – 61.142		
FC ERROR	61.23	Errore misurazione regime di rotazione	<ul style="list-style-type: none"> - Il disinserimento dell'apparecchiatura non è ammesso, fino a quando l'indicazione della rotazione  è luminosa e ruota. Attendere fino a quando il simbolo  (coperchio bloccato) viene esposto (dopo ca. 120 secondi). Eseguire poi un RESET RETE.
TACHO ERR	61.22		
FC ERROR	61.153	Guasto/difetto sistema elettronico.	<ul style="list-style-type: none"> - Esecuzione di un RESET RETE. - Controllare il caricamento del rotore, vedere il capitolo "Carico del rotore". - Ripetere il ciclo di centrifugazione.

25 Sostituzione fusibili entrata rete



Spegnere l'interruttore di rete e staccare l'apparecchio dall'alimentazione!

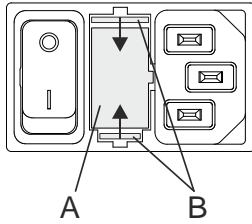

Il portafusibili (A) con i fusibili d'entrata rete si trova accanto all'interruttore di rete.

- Estrarre il cavo di collegamento dalla spina.
- Premere la chiusura a scatto (B) contro il portafusibili (A) ed estrarre quest'ultimo.
- Sostituire i fusibili di rete difettosi.



Utilizzate solo fusibili con valori nominali fissati per il rispettivo tipo, vedere la successiva tabella.

- Inserire di nuovo il portafusibili fino a far scattare la chiusura.
- Allacciare di nuovo l'apparecchio alla rete.

Modello	Tipo	Fusibile	N° ord.
HAEMATOKRIT 200	1801	T 3,15 AH/250V	E997
HAEMATOKRIT 200	1801-01	T 6,3 AH/250V	2266

26 Rispedizione di apparecchi



Prima di rispedire un apparecchio deve essere montata la protezione per il trasporto.

Se l'apparecchio o uno dei suoi accessori viene rispedito alla ditta Andreas Hettich GmbH & Co. KG, esso deve essere prima decontaminato e pulito per la tutela di persone, ambiente e materiale.

Ci riserviamo la facoltà di accettare apparecchi o accessori contaminati.

Eventuali costi di pulizia e disinfezione verranno fatturati al cliente.

Contiamo a questo riguardo sulla vostra comprensione.

27 Smaltimento

Prima dello smaltimento, l'apparecchiatura deve essere decontaminata e pulita con lo scopo di proteggere le persone, l'ambiente e il materiale.

Per lo smaltimento dell'apparecchio osservare le rispettive norme di legge.

Ai sensi della direttiva 2002/96/CE (RAEE) tutti gli apparecchi forniti dopo il 13/08/2005 non possono più essere smaltiti con i rifiuti domestici. Questo apparecchio appartiene alla categoria 8 (Dispositivi medicali) ed è classificato nel settore Business-to-Business.







Il simbolo della pattumiera cancellata con una croce indica che l'apparecchio non deve essere smaltito con i rifiuti domestici.

Le norme per lo smaltimento possono essere differenti nei singoli paesi UE. In caso di necessità rivolgersi al proprio rivenditore.

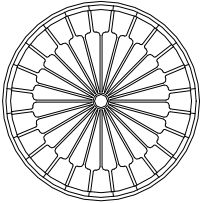
28 Anhang / Appendix

28.1 Rotoren und Zubehör / Rotors and accessories

2076								
Hämatokritrotor 24-fach (mit Deckel) Haematocrite rotor 24-times (with lid)								
								
								
Maße / dimensions \varnothing x L	mm	1,4 x 75						
Anzahl p. Rotor / number p. rotor		24						
Drehzahl / speed	RPM	13000						
RZB / RCF		16060						
Radius / radius	mm	85						
 (97%)	sec	8						
 f	sec	10						
Probenerwärmung/sample temp. rise	K ¹⁾	19						

1) Probenerwärmung bei maximaler Drehzahl und 1 Stunde Laufzeit

1) Sample temp. rise during maximum speed and 1 hour running time