

Vortexer Tube Roller  
Orbital Shaker  
Linear Shaker  
Magnetic Stirrer



Vortexer



Magnetic Stirrer



Orbital and Linear Shaker



Tube Roller

Stirrer, Mixer and Shaker

## Idea

PHOENIX INSTRUMENT GmbH starts with a new concept to comply customer demands for high-quality but also well-priced laboratory instruments.

## Implementation

Absolute customer orientation and satisfaction is the focus of all activities of PHOENIX INSTRUMENT.

## Your Benefit

As our customer you will take advantage of our long market experience, the attractive prices and the short delivery times. We guarantee comprehensive and competent consultations in all aspects and will always listen to your wishes, ideas and suggestions. It goes without saying that PHOENIX INSTRUMENT offers a technical service, if required.

## Stirrer, Mixer and Shaker

Magnetic Stirrer with and without heating, analog and digital	Page 3
Magnetic Stirrer Budget line, with and without heating	Page 4
Magnetic Stirrer with glass ceramic plate, with heating	Page 5
Multi place stirrer with and without heating	Page 6
Accessories Magnetic Stirrer	Page 6
Digital Orbital- and Linearshaker	Page 7
Analog Orbital- and Linearshaker	Page 8
Digital Rocking- and 3D-Shaker	Page 9
Analog Rocking- and 3D-Shaker	Page 10
Accessories Rocking- and 3D-Shaker	Page 11
Incubation Shaker	Page 12
Digital Rotator and Disk mixer	Page 13
Analog Rotator and Disk mixer	Page 14
Accessories Rotator and Disk mixer	Page 15
Tuberoller	Page 16
Vortexer, Mikroplate mixer	Page 17
Overhead Stirrer	Page 18
Accessories Overhead Stirrer	Page 19

## Magnetic Stirrer RSM-01 • RSM-02+

The magnetic stirrer of the RSM-line from PHOENIX INSTRUMENT offers the ideal products for the daily lab routine. The user can select between a digital and an analog version. As a matter of course both versions are available with a hotplate, either with stainless steel surface or porcelain enamel surface. We grant 2 years warranty on both models.

The comprehensive list of accessories includes everything you require from a stand bar over a temperature sensor and protection covers up to various top frames for reactor vessels.



RSM-01HP



RSM-02HP+

### RSM-01

- Typical magnetic stirrer in a modern Design
- Hotplate with stainless steel or with porcelain surface
- Model RSM-01 HP and RSM-01 HS with hotplate
- sturdy metal housing IP 42
- high stirring power
- 2 years warranty



Indikator for hot surface

### RSM-02+

- Magnetic stirrer of the latest generation
- connector for PT-1000, integrated control function
- digital adjustment with backlit Display
- RS 232 to control the stirrer and to display all parameter via Computer
- adjustable safety temperature (100-350°C)
- Indikator for hot surface, even when stirrer is shut-off
- comprehensive range of accessories
- 2 years warranty

Technical data	RSM-01 HP	RSM-01 HS	RSM-01 S	RSM-02 HP+	RSM-02 HS+
Voltage (V)	200-240	200-240	100-240	200-240	200-240
Power (W)	530	530	530	530	530
max. stirr. quantity (l H <sub>2</sub> O)	20	20	20	20	20
Stirrer bar (max. in mm)	80	80	80	80	80
Plate (Ø mm)	135	135	135	135	135
Plate Material	Stainless steel porcelain surface	Stainless steel	Stainless steel	Stainless steel porcelain surface	Stainless steel
Speed	50-1500	50-1500	50-1500	100-1500	100-1500
Adjustment of speed	analog	analog	analog	digital	digital
Temperature range (°C)	RT+5 to 340	RT+5 to 340	-	RT+5 to 340	RT+5 to 340
Adjustment of Temperature	analog	analog	-	digital	digital
RS-232	no	no	no	yes	yes
Dimensions (mm)	280 x 160 x 85	280 x 160 x 85	280 x 160 x 85	280 x 160 x 85	280 x 160 x 85
Protection class	IP 42	IP 42	IP 42	IP 42	IP 42
Weight (kg)	2,8	2,8	2,8	2,8	2,8

## Budget Magnetic Stirrer RSM-10

New and unique magnetic stirrer of the budget level. Many important features of a standard instrument, such as the control of parameter via LED-Display, the integrated temperature control and the sealed construction (IP42) are part of the standard equipment of this very interesting line. The integrated temperature control allows an exact regulation of the sample when the temperature sensor PT-1000 is connected.

... and all that at very attractive and competitive prices.

### RSM-10 A

- compact construction
- sealed housing (IP42)



RSM-10 B

### RSM-10 B

- LED-display for precise control of the speed
- digital speed regulation
- compact construction
- sealed housing (IP42)

### RSM-ECO

- powerful Magnet
- stepless speedcontrol from 300 up to 2000 rpm
- compact, sealed housing
- silent, vibration free use
- maintenance-free Motor
- includes mount for pH-elektrodes



RSM-10 HS/HP

### RSM-10 HS/HP

- LED-Display for accurate regulation of speed and temperature
- digital controlled speed and temperature
- Indicator for hot surface, even when stirrer is shut-off
- connector for PT-1000
- integrated temperature control function
- compact construction, sealed housing (IP42)

2 years warranty

Technical data	RSM-10 HS	RSM-10HP	RSM-10A	RSM-10B	RSM-ECO
Voltage (V)	200-240	200-240	100-240	100-240	100-240
Max. stirring quantity (l H <sub>2</sub> O)	3	3	3	3	1,5
Stirrer bar (max. in mm)	50	50	50	50	40
Speed (rpm)	200-1500	200-1500	50-1500	100-1500	300-2000
Display accuracy(rpm)	10	10	-	10	-
Display	LED	LED	analog, Scale	LED	-
Plate (mm)	Ø135	Ø135	Ø135	Ø135	Ø120
Surface	Stainless steel	Porcelain surface	plastic	plastic	ABS
Temperature range (°C)	RT+5 to 280	RT+5 to 280	-	-	-
Temp. accuracy (°C)	1	1	-	-	-
Control accuracy (°C)	±2	±2	-	-	-
Power (W)	500	500	-	-	-
Safety temperature (°C)	320	320	-	-	-
Dimensions (mm)	155 x 215 x 100	155 x 215 x 100	155 x 215 x 75	155 x 215 x 75	150 x 145 x 50
Protection class	IP 42	IP 42	IP 42	IP 42	IP 21
Weight (kg)	1,5	1,5	0,9	0,9	0,3

## Magnetic Stirrer with glass ceramic plate RSM-04H • RSM-05H

The magnetic stirrer RSM-04 and RSM-05 are characterized by an extremely sturdy construction and the excellent chemical resistance of the huge glass ceramic plate. The RSM-04 and the RSM-05 offers sufficient power even for thermally challenging tasks with a working temperature up to 550°C. The integrated temperature control allows an exact regulation of the sample when the temperature sensor PT-1000 is connected.



RSM-04H



RSM-05H

Technical data	RSM-04H	RSM-05H
Voltage (V)	200-240	200-240
Power (W)	1050	1050
Max. stirring volume (l H <sub>2</sub> O)	10	20
Stirrer bars (max. in mm)	80	80
Plate (mm), surface	184 x 184 glass ceramic	184 x 184 glass ceramic
Speed (rpm)	100-1500	100-1500
Temperature range (°C)	RT+5 to 550	RT+5 to 550
Safety temperature (°C)	580	100-580
Display	LED	LCD
RS-232	No	Yes
Dimensions (mm)	215 x 340 x 110	215 x 340 x 110
Protection class	IP 21	IP 21
Weight (kg)	4,6	4,4

### RSM-04H • RSM-05H

- sturdy full metal housing
- backlit digital display or LED
- glass ceramic hotplate
- selectable safety temperature (RSM-05H)
- hot plate warning
- connector for PT-1000
- integrated control function, no contact thermometer necessary
- RS-232 Interface (RSM-05H)
- high stirring volume, up to 20l with RSM-05H
- 2 years warranty

## Multi Channel Magnetic Stirrer RSM-03



RSM-03-16K



RSM-03-10KH

- 10-/16 channel magnetic stirrer
- Model RSM-03-10KH with hotplate
- sturdy construction (IP 42)
- stepless speed regulation
- stainless steel plate with silicone films, anti-slip and anti-corrosion
- uniform temperature distribution
- 2 years warranty

Technical data	RSM-03-10KH	RSM-03-10K	RSM-03-16K
Voltage (V)	200-240	100-240	100-240
Power(W)	490	20	20
Stirring points	10	10	16
Max. stirring quantity (l H <sub>2</sub> O)	0,4 / Stirring point	0,4 / Stirring point	0,4 / Stirring point
Stirring point (Ø mm)	85	85	85
Stirring bar (max. in mm)	40	40	40
Material plate	Stainless steel with silicon films	Stainless steel with silicon films	Stainless steel with silicon films
Speed (rpm)	50-1100	50-1100	50-1100
Speed control	analog	analog	analog
Temperature range (°C)	RT-120	-	-
Dimensions ( in mm)	182 x 552 x 65	182 x 552 x 65	380 x 522 x 65
Protection class	IP 42	IP 42	IP 42
Weight (kg)	3,2	3,2	6

### Accessories Magnetic Stirrer

- RSM-E 100 Carrier plate for hotplate Stainless steel (RSM-01/02/10 HS)  
 RSM-E 110 Red quarter pie, 4ml reaction vessel, 9-holes, Ø 15,2 mm, depth 19 mm, to be used with RSM-E 100  
 RSM-E 120 Purple quarter pie 20 ml reaction vessel, 4-holes, Ø 28 mm, depth 24 mm, to be used with RSM-E 100  
 RSM-E 130 Blue quarter pie, 30 ml reaction vessel, 4-holes, Ø 28 mm, depth 30 mm, to be used with RSM-E 100  
 RSM-E 140 black Quarter pie, 40 ml reaction vessel, 4-holes, Ø 28 mm, depth 42,8 mm, to be used with RSM-E 100  
 RSM-E 150 green Quarter pie, 8 ml reaction vessel, 8-holes, Ø 17,75 mm, depth 25,5 mm, to be used with RSM-E 100  
 RSM-E 160 golden Quarter pie, 16ml reaction vessel, 4-holes, Ø 21,6 mm, depth 31,7 mm, to be used with RSM-E 100

- RSM-E 170 Reaction Block for round flask 50 ml  
 RSM-E 172 Reaction block for round flask 100 ml  
 RSM-E 174 Reaction block for round flask 250 ml  
 RSM-E 176 Reaction block for round flask 500 ml  
 RSM-E 310 Stirrer bar remover

- RSM-E 320 PT-1000 for RSM-04/05/10 H  
 RSM-E 330 Stand for RSM-01, -02, -04 and -05  
 RSM-E 335 Stand for RSM-10  
 RSM-E 340 Protection cover for RSM-01/02 without hotplate  
 RSM-E 350 Protection cover for RSM-01/02 with hotplate  
 RSM-E 360 Protection cover for RSM-10 HS/HP

*Various Stirrer Bars  
on request*



Quarter Pies  
on Carrier Plate

## Digital Linear- and Orbitalshaker RS-OS • RS-LS

A compact orbital and linear shaker with ideal swivel motion, for a maximum shaking weight of 7.5kg. The shakers can be set up individually by using the comprehensive range of accessories.

### RS-OS 10/20 • RS-LS 10/20

- compact shaker with a maximum capacity of 2,5/ 7,5 kg
- backlit display
- easy adjustment of time and speed
- fix stand with anti-slipping feet
- adjustable safety speed
- RS 232-interface
- comprehensive range of accessories
- 2 years warranty



RS-OS-10/20

Technical data	RS-OS 10	RS-OS 20	RS-LS 10	RS-LS 20
Voltage (V)	100-240	100-240	100-240	100-240
Power (W)	30	30	30	30
Shaking movement	orbital	orbital	linear	linear
Orbital diameter (mm)	4	10	4	10
Max. shaking weight (kg)	2,5	7,5	2,5	7,5
Speed	100-800	100-500	100-350	100-350
Timer-Function	yes	yes	yes	yes
Operation	Time/Continuous	Time/Continuous	Time/Continuous	Time/Continuous
Display	LCD/LCD	LCD/LCD	LCD/LCD	LCD/LCD
Adjustment Speed/Time	digital/digital	digital/digital	digital/digital	digital/digital
RS-232	yes	yes	yes	yes
Dimensions (mm)	340 x 300 x 100	420 x 370 x 100	340 x 300 x 100	420 x 370 x 100
Dimensions Platform (mm)	240 x 240	320 x 320	240 x 240	320 x 320
Protection Class	IP 21	IP 21	IP 21	IP 21
Weight (kg)	8,1	13,5	8,1	13,5

## Analog Orbital- and Linear Shaker RS-OS 5 • RS-LS 5

New economic laboratory shaker of the Phoenix RS-OS and RS-LS-line for gentle and effective sample mixing. Both versions have a max. shaking weight of 3 kg. An individual configuration of your shaker is easily possible by using the comprehensive range of accessories and all that at very competitive prices.

### RS-OS 5 • RS-LS 5

- compact lab shaker with a max. capacity of 3 kg
- stable stand, adjustable feet
- Disk attachment included
- comprehensive range of accessories
- 2 years warranty



RS-OS 5

Technical data	RS-OS 5	RS-LS-5
Voltage (V)	100-240	100-240
Power (W)	30	30
Shaking movement	orbital	linear
Diameter max. (mm)	20	20
Max. shaking weight (kg)	3	3
Speed (rpm)	50-200	50-200
Timer function	no	no
Operation	Continuous	Continuous
Display	Scale	Scale
Adjustment Speed/Time	analog	analog
RS-232	yes	yes
Dimension (mm)	330 x 270 x 110	330 x 270 x 110
Platform size (mm)	240 x 240	240 x 240
Protection class	IP 21	IP 21
Weight	3,1	3,1



## Digital Rocking and 3D Shaker RS-RR 10 • RS-RD 10

New and powerful shaker for gentle mixing of samples. The adjustment and control of speed and time can be done easily via the LCD-Display with this fully digital version. An individual configuration of your shaker is easily possible by using the comprehensive range of accessories.

### RS-RR 10 • RS-RD 10

- gentle sample mixing
- sturdy construction
- backlit display
- simultaneous display of speed and time
- fix stand with anti-slipping feet
- attachment included
- comprehensive range of accessories
- 2 years warranty



RS-RD 10



RS-RR 10

Technical data	RS-RR 10	RS-RD 10
Voltage/Frequency (V, Hz)	100-240 / 50-60	100-240 / 50-60
Shaking movement	Sea-Saw rocking	3D orbital
Angle (°)	±9	±9
Speed (rpm)	10-70	10-70
Display	LCD	LCD
Timer function (min)	yes, 1-1199	yes, 1-1199
Operation	Timer / Continuous	Timer / Continuous
Capacity (kg)	10	5
Dimension (mm)	410 x 360 x 106	430 x 360 x 200
Platform Size (mm)	320 x 320	320 x 320
Ambient Temperature (°C)	5 - 40	5-40
Protection class	IP 21	IP 21
Weight (kg)	9	9

### Analog Rocking and 3D-Shaker RS-RS 5 • RS-DS

New economic laboratory shaker of the Phoenix RS-RS and RS-DS-line for gentle and effective sample mixing. Both versions have a max. shaking weight of 3 kg. An individual configuration of your shaker is easily possible by using the comprehensive range of accessories and all that at very competitive prices.



#### RS-RS 5 - RS-DS 5

- compact laboratory shaker with a max. capacity of 3 kg
- stable stand and adjustable feet
- Disk attachment included
- comprehensive range of accessories
- 2 years warranty

RS-DS 5

Technical data	RS-RS 5	RS-DS 5
Voltage (V)	100-240	100-240
Power (W)	30	30
Shaking movement	Sea-Saw rocking	3D orbital
Angle	± 7°	± 7°
Max. Shaking weight (kg)	3	3
Speed (rpm)	5-80	5-80
Timer function	no	no
Operation	Continuous	Continuous
Display Speed / Time	scale	scale
Adjustment Speed	analog	analog
Dimension (mm)	330 x 270 x 110	330 x 270 x 110
Platform size (mm)	240 x 240	240 x 240
Protection class	IP 21	IP 21
Weight (kg)	2,9	3,2

## Shaker Accessories

- RSS-E 100 Universal attachment with clamping rolls for OS/LS 5/10, RS-RS 5, RS-DS 5
- RSS-E 105 Base plate for OS/LS 5/10 to be used with Erlenmeyer-clips, RS-RS 5, RS-DS 5, for attaching Erlenmeyer Flasks
- RSS-E 110 Universal attachment with vertical adjustable clamping rolls for OS/LS 5/10, RS-RS 5, RS-DS 5
- RSS-E 115 Dish attachment for OS/LS 5/10, RS-RS 5, RS-DS 5, including fixing belts

- RSS-E 160 Dish attachment for OS/LS 5/10, RS-RS 5, RS-DS 5, 200 x 300 mm, incl. fixing belts
- RSS-E 165 Dish attachment for OS/LS 5/10, RS-RS 5, RS-DS 5, 280 x 280 mm
- RSS-E 168 Connector sticks for RSS-E 160/165, to use two attachments

- RSS-E 200 Universal attachment with clamping rolls for OS/LS 20
- RSS-E 205 Base plate for OS/LS 20 to be used with Erlenmeyer-clips
- RSS-E 210 Universal attachment with vertical adjustable clamping rolls for OS/LS 20

- RSS-E 220 Attachment for 2D- and 3D-Shaker

- RSS-E 120 Fixing clip for 25 ml Erlenmeyer flask
- RSS-E 125 Fixing clip for 50 ml Erlenmeyer flask
- RSS-E 130 Fixing clip for 100 ml Erlenmeyer flask
- RSS-E 135 Fixing clip for 200/250 ml Erlenmeyer flask
- RSS-E 140 Fixing clip for 500 ml Erlenmeyer flask

- RSS-E 145 clamping rolls for universal attachment OS/LS 5/10
- RSS-E 245 clamping rolls for universal attachment OS/LS 20

- RSS-E 250 100 ml Erlenmeyer- flask with baffles
- RSS-E 251 250 ml Erlenmeyer-flask with baffles
- RSS-E 252 500 ml Erlenmeyer-flask with baffles

- RSS-E 253 100 ml culture flask with baffles
- RSS-E 254 250 ml culture flask with baffles
- RSS-E 255 500 ml culture flask with baffles

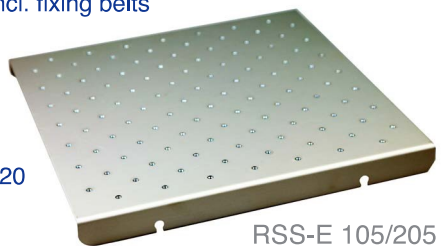

RSS-E 105/205

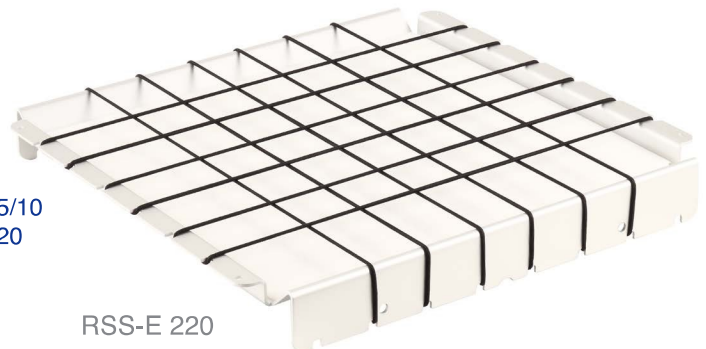

RSS-E 220



RSS-E 120

RSS-E 125

RSS-E 130

### Fixing Clips for Erlenmeyer Flasks



RSS-E 135

RSS-E 140

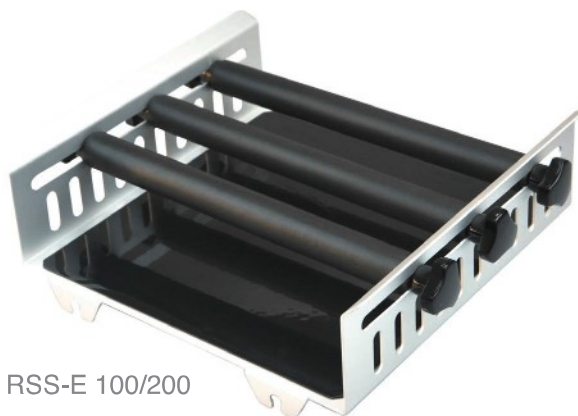

RSS-E 100/200

### Maximum attachment RSS-E 105/205 with Fixing Clips for Erlenmeyer Flasks

Att. / Fixing Clip	25 ml	50 ml	100 ml	250 ml	500 ml
RSS-E 105	18	18	9 (12)*	6 (8)*	4 (5)*
RSS-E 205	28	28	16	9 (12)*	9

\* Erlenmeyer Flasks overlapping

## Incubation Shaker IS-OS 20

The new shaking incubator IS-OS 20 combines two typical laboratory operation in one instrument: shaking and incubation of samples. It is ideal for cell culture, solubility studies, extraction procedures and many other laboratory applications. The built-in fan guarantees a uniform distribution of the temperature. IS-OS20 will be supplied with a standard platform equipped with flexible springs that can accommodate many type of flasks, becker, tubes with different sizes.



IS-OS 20

Technical data	IS-OS 20
Temperature range / Resolution (°C)	RT+5-60 / 0,1
Temperature dispersal (at 37 °C)	± 0,5
Temperature accuracy ( °C)	± 0,1
Operation	99:59 and Continuous
Air circulation	forced
Speed (rpm)	40...300
Amplitude of movement (mm)	20
Capacity	7 x 500 ml Erlenmeyer Flask 4 x 1000 ml Erlenmeyer Flask
Dimension Platform (mm)	320 x 320
Power (W)	500
Dimensions (mm)	500 x 610 x 470
Material of hood / Thickness (mm)	Plexiglas / 8
Weight (kg)	40
Adjustable safety temperature	yes
Safety control „opening door“	yes

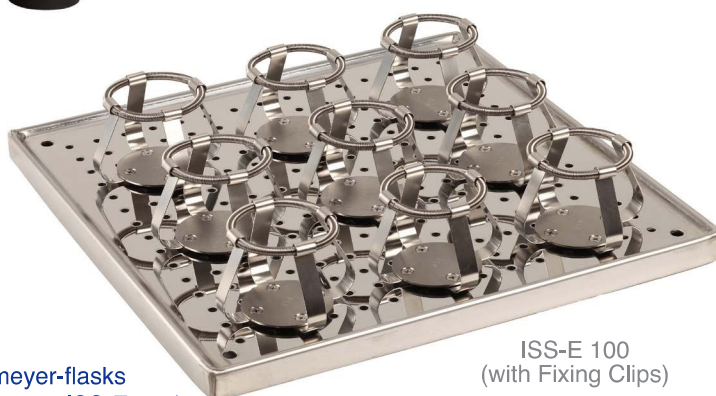

ISS-E 100  
(with Fixing Clips)

### Accessories

- ISS-E 100 Baseplate to be used with fixing clips for Erlenmeyer-flasks
- ISS-E 130 Fixing clip 100 ml for Erlenmeyer flasks (max. 16 pro ISS-E 100)
- ISS-E 135 Fixing clip 200/250 ml for Erlenmeyer flasks (max. 9 pro ISS-E 100)
- ISS-E 140 Fixing clip 500 ml for Erlenmeyer flasks (max. 9 pro ISS-E 100)
- ISS-E 150 Fixing clip 1000 ml for Erlenmeyer flasks (max. 4 pro ISS-E 100)

## Rotator RS-RR 20 and Disc-Mixer RS-RD 20

New and high-value rotator for gentle and effective mixing samples in various tubes and flasks. Adjustment and control of the parameter speed and time can be done easily via the LCD-display. Various drum tube holders (for model-no. RS-RR20) and disk tube holders (for model-no. RS-RD20) are available as accessories. The RS-RR 20 can easily be converted into a disk mixer.



RS-RR 20

### RS-RR 20 • RS RD 20

- instrument will be supplied incl. tube holder (RS-RR20) or disk mixer (RS-RD 20)
- Dual-Use - rotator RS-RR 20 can also be used as disk mixer
- fix stand with anti-slipping feet
- backlit display to adjust speed and time
- comprehensive range of accessories
- 2 years warranty

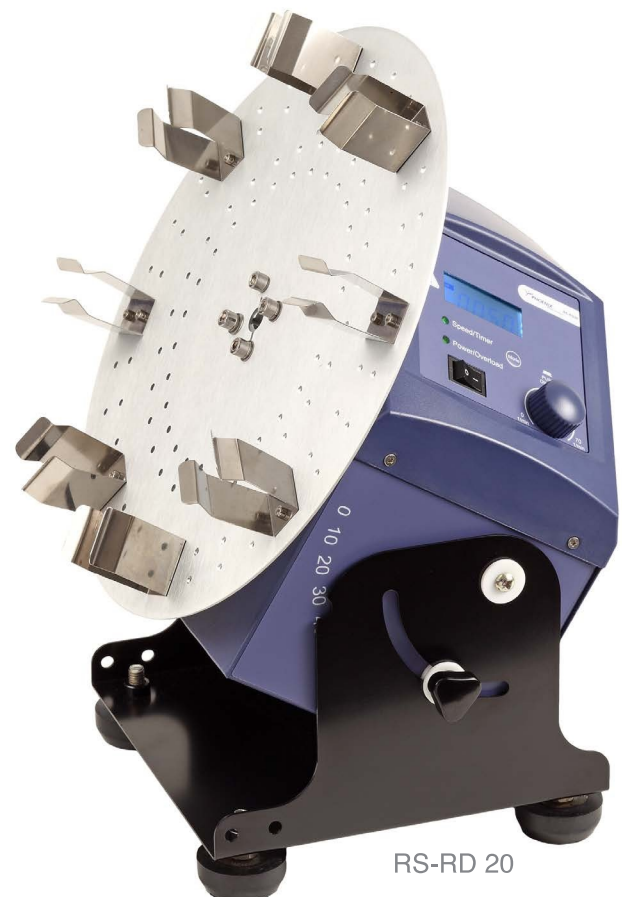

RS-RD 20

Technical data	RS-RR 20	RS-RD 20
Voltage (V/Hz)	100-240	100-240
Shaking movement	40	40
Angle Range (°C)	Rotation	Rotation Disc
Speed (rpm)	-	0-90°
Display	10-70	10-70
Timer-Function (Min)	yes	yes
Operation	Time/Continuous	Time/Continuous
Oscillation braking device	LCD/LCD	LCD/LCD
Dimensions (in mm)	digital/digital	digital/digital
Ambient temperature (°C)	510 x 190 x 260	250 x 190 x 260
Protection class	IP 21	IP 21
Weight (kg)	8	6,5

## Analog Rotator and Discmixer RS-RR 5 • RS-RD 5

New economic Rotator and Disk mixer of the Phoenix RS-RR and RS-RD-line for gentle and effective sample mixing. Both versions have a max. shaking weight of 3 kg. An individual configuration of your shaker is easily possible by using the comprehensive range of accessories and all that at very competitive prices.



RS-RR 5

### RS-RR 5 • RS-RD 5

- Accessories for 1,5/2 ml, 15 ml and 50 ml tubes are included
- variable Speed
- compact construction
- adjustable feet
- easy to clean
- 2 years warranty



RS-RD 5

Technical data	RS-RR 5	RS-RD 5
Voltage (V)	100-240	100-240
Power (W)	20	20
Movement	Rotation	Rotation Disk
Rotation angle	-	90°
Speed (rpm)	5-80	5-80
Timer	-	-
Operation	Continuous	Continuous
Display Speed/Time	Scale	Scale
Speed adjustment	analog	analog
Dimension (mm)	530 x 150 x 190	2200 x 300 x 310
Protection class	IP 21	IP 21
Weight (kg)	1,7	2

## Rotator and Discmixer Accessories

RSE-RR 05	Rotator modul for RS-RR 20, 48 x 1,5 ml tubes, horizontal mixing
RSE-RR 10	Rotator modul for RS-RR 20, 24 x 15 ml tubes, horizontal mixing
RSE-RR 15	Rotator modul for RS-RR 20, 24 x 50 ml tubes, horizontal mixing
RSE-RR 25	Rotator modul for RS-RR 20, 32 x 1,5 ml tubes, vertical mixing
RSE-RR 30	Rotator modul for RS-RR 20, 16 x 15 ml tubes, vertical mixing
RSE-RR 35	Rotator modul for RS-RR 20, 16 x 50 ml tubes, vertical mixing
RSE-RD 05	Disk modul for RS-RD 20, 60 x 1,5 ml tubes
RSE-RD 10	Disk modul for RS-RD 20, 16 x 15 ml tubes
RSE-RD 15	Disk modul for RS-RD 20, 8 x 50ml tubes
RSE-RD 50	Adapter to use several disk moduls
RSE-RD 20	12 x 1,5/2 ml Fixing Clips for RS-RR 5 and RS-RD 5
RSE-RD 22	12 x 15 ml Fixing Clips for for RS-RR 5 and RS-RD 5
RSE-RD 24	12 x 50 ml Fixing Clips for RS-RR 5 and RS-RD 5



RSE-RD 05

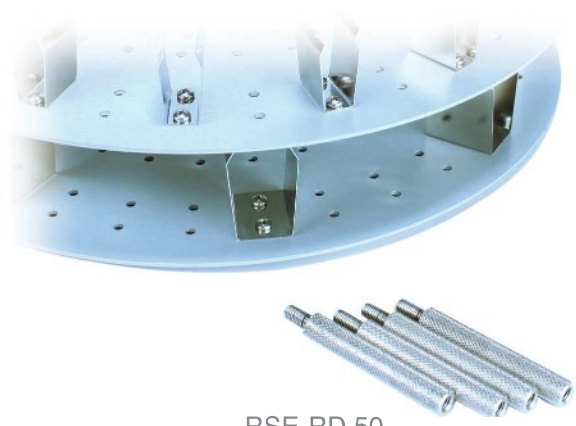

RSE-RD 50



RSE-RR 5

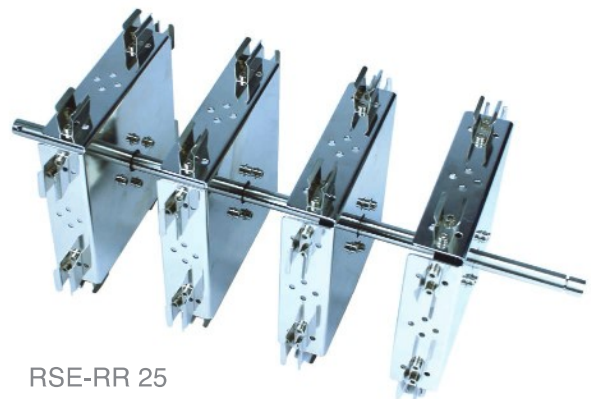

RSE-RR 25

### Tube Roller RS-TR 5/10

The new tube rollers provides gentle and effective mixing by rocking and rolling action. The adjustment and control of the parameter speed and time can be done easily via LCD Display on the digital version RS-TR 10. On the analog version RS-TR 5 the adjustment will be done with a knob and a scale. We are offering 2 years warranty on both instruments.



RS-TR 5



RS-TR 10

Technical data	RS-TR 5	RS-TR 10
Voltage (V/Hz)	100-240	100-240
Power (W)	25	30
Shaking movement	Rocking and rolling	Rocking and rolling
Number of rolls	6	6
Speed (rpm)	5-70	10-70
Timer function	-	yes
Operation	Continuous	Time/Continuous
Display Speed/Time	Scale	LCD/LCD
Timer function	analog	digital/digital
Dimensions (mm)	460 x 260 x 120	530 x 260 x 120
Protection class	IP 21	IP 21
Weight (kg)	4,5	5,5



## Vortexer and Micro Plate Mixer RS-VF 10 • RS-VA 10 and RS-MM 10

The new Vortex mixer is suitable for touch or continuous operation. The compact, universal small Micro plate Mixer is suitable for small vessels and 96 micro titer plates and guarantees a wide range of attachments, easy installation and replacement.



**RS-MM 10**

- compact Mixer suitable for 96er Micro titer plates
- adjustable speed
- various top frames available for RS-MM 10
- 2 years warranty



**RS-VF 10 • RS-VA 10**

- Touch- or continuous
- variable speed 0-2500 rpm (RS-VA 10)
- anti-slipping feet
- various top frames available for RS-VA 10
- sturdy cast housing
- 2 years warranty

### Accessories

RSV-E 10 Universal attachment for Tubes and fessels up to 30 mm Ø

RSV-E 44 Universal attachment for Tubes and fessles up to 99 mm Ø  
(in connetion with RSV-E 15)

RSV-E 12 Holding bar for RSV-E 20-40

RSV-E 15 100 mm Plate, incl. rubber feet, for Vortexer

RSV-E 20 Tube adapter for 48 Tubes 6 mm Ø, to be used with RSV-E 15

RSV-E 25 Tube adapter for 15 Tubes 10 mm Ø, to be used with RSV-E 15

RSV-E 30 Tube adapter for 12 Tubes 12 mm Ø, to be used with RSV-E 15

RSV-E 35 Tube adapter for 8 Tubes 16 mm Ø, to be used with RSV-E 15

RSV-E 40 Tube adapter for 8 Tubes 20 mm Ø, to be used with RSV-E 15

RSV-E 46 Rubber feet

RSV-E 50 Universal attachment for Micro titer plate mixer  
to be used with RSV-E 20-40

RSV-E 55 Microtiterplate attachment for one plate for RS-MM 10

RSV-E 57 Microtiterplate attachment for two plates for RS-MM 10



RSV-E 15



RSV-E 20-40



RSV-E 44



RSV-E 55

### Technical data

Technical data	RS-VF 10	RS-VA 10	RS-MM 10
Voltage (V)	100-240	100-240	100-240
Power (W)	60	60	20
Shaking movement	orbital	orbital	orbital
Orbital diameter (mm)	4	4	4,5
Speed (rpm)	2500 fix	0-2500	0-1500
Speed adjustment	Switch	-	Switch
max. load (kg)	-	-	0,5
Dimension (mm)	127 x 160 x 130	127 x 160 x 130	150 x 80 x 260
Protection class	IP 21	IP 21	IP 21
Weight (kg)	3,5	3,5	3



RSV-E 18

## Overhead Stirrer RSO-20/40 (analog and digital)

The new line of overhead stirrer RSO-20 and RSO-40 convinces with outstanding characteristics and a brilliant price/performance ratio.



RSO-40D

### RSO-20/40A

- digital speed readout
- stepless speed adjustment
- sturdy construction
- very quiet operation
- safety circuit
- 2 years warranty

### RSO-20/40D

- digital stirrer with LCD-display
- micro-processor controlled speed accuracy
- smooth start procedure
- selectable display of speed/torque
- RS 232 Interface
- 2 years warranty



RSO-20A

#### Technical data

	RSO-20A	RSO-40A	RSO-20D	RSO-40D
Max.stirring quantity(l H <sub>2</sub> O)	20 l	40 l	20 l	40
Motor rating input (W)	70	130	70	130
Motor rating output	50	100	50	100
Speed (rpm)	50-2200, stepless	50-2200, stepless	50-2200, stepless	50-2200, stepless
Speed accuracy	-	-	± 3	± 3
Display	LED	LED	LCD	LCD
Max. Viscosity (mPas)	10.000	50.000	10.000	50.000
Max. torque (Ncm)	30	60	30	60
Ø chuck range (mm)	0,5-10	0,5-10	0,5-10	0,5-10
Push through shaft	yes	yes	yes	yes
Fastening on stand	Extension 16 mm	Extension 16 mm	Extension 16 mm	Extension 16 mm
Torque display	no	no	no	no
Dimension (in mm)	83 x 220 x 186	83 x 220 x 186	83 x 220 x 186	83 x 220 x 186
Weight (kg)	2,5	3,5	2,5	3,5
Protection class I	IP 21	IP 21	IP 21	IP 21
RS-232	no	no	no	no
Voltage (V)	100-240	100-240	100-240	100-240
Frequency (Hz)	50/60	50/60	50/60	50/60

## Overhead Stirrer Accessories



- RSO-E 07 Plate stand with holding clamp and limiter
- RSO-E 10 Propeller stirrer with 4 blades, stirrer diameter 50 mm,  
Shaft diameter 8 mm, Shaft length 400 mm
- RSO-E 11 Paddle stirrer, stirrer diameter 70 mm,  
Shaft diameter 8 mm, shaft length 400 mm
- RSO-E 12 Propeller stirrer with a flexible blade, stirrer diameter 60 mm,  
Shaft diameter 8 mm, shaft length 400 mm
- RSO-E 13 Centrifugal stirrer, shaft diameter 90 mm,  
Shaft diameter 8 mm, shaft length 400 mm
- RSO-E 20 Propeller stirrer PTFE-coated with 4 blades, stirrer diameter 65 mm,  
Shaft diameter 6 mm, shaft length 350 mm
- RSO-E 21 Propeller stirrer PTFE-coated with 2 blades, stirrer diameter 70 mm,  
Shaft diameter 6 mm, shaft length 350 mm
- RSO-E 22 Paddle stirrer PTFE-coated, stirrer diameter 70 mm,  
Shaft diameter 6 mm, shaft length 350 mm
- RSO-E 23 Centrifugal stirrer PTFE-coated, shaft diameter 90 mm,  
Shaft diameter 6 mm, shaft length 350 mm

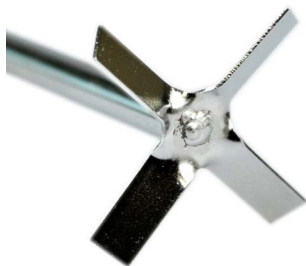

RSO-E10



RSO-E11



RSO-E12



RSO-E13

# PHOENIX Instrument

Lab solutions



In addition to Stirrer and Shaker Phoenix Instrument also offers Rotary Evaporator, Balances, Centrifuges, Liquid Handling, Water baths, Incubator, Ovens, pH- and conductivity meter



Issue fall 2017, subject to alterations



info@phoenix-instrument.de • Tel. +49 (5131) 90818 -30  
Heinkelstr. 4 • D-30827 Garbsen • www.phoenix-instrument.de

