



DOC022.53.80116

HQ440d, HQ430d, HQ411d

05/2017, Edition 4

User Manual

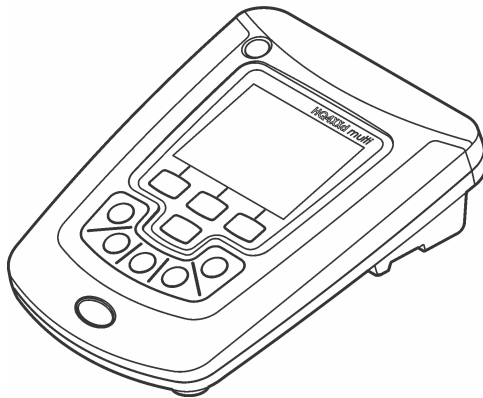

Specifications	3
General information	3
Safety information	3
Use of hazard information	4
Precautionary labels	4
Product overview	4
Product components	5
Installation	6
Connect to AC power	6
Install the batteries	7
User interface and navigation	8
User interface	8
Display description	8
Navigation	10
Startup	10
Turn the meter on and off	10
Change the language	10
Change the date and time	10
Connect a probe	11
Standard operation	12
About calibration	12
About sample measurements	12
About check standards	12
Use a sample ID	12
Use an operator ID	12
Data management	13
About stored data	13
View stored data	13
View stored probe data	14
Print stored data	14
Change the report options	15
Send data to a USB storage device	15
Open data files on a PC	16
Data file description	16
Remove column headers	18
Send data directly to a computer	18
Advanced operation	18
Security options	18
Turn Security Options on	19
Full access options menu	19
Restricted operator access options menu	20
Set the display options	21
Set the sound options	21
Set the probe calibration reminder	21

Table of Contents

Change the temperature units	22
Set the measurement mode	22
Set auto measurement intervals	22
Start interval measurements	22
Prevent data log overflow in interval mode	23
View instrument information	23
Update the meter software	23
Download software updates	24
Transfer method settings	24
Bi-directional Communication between the meter and a PC	24
About meter control	25
About meter configuration	25
Maintenance	25
Clean the meter	26
Replace the batteries	26
Troubleshooting	26
Replacement parts and accessories	28
Examples of printed reports	29

Specifications

Specifications are subject to change without notice.

Specification	Details
Dimensions	17.48 x 8.59 x 23.5 cm (6.88 x 3.38 x 9.25 in.)
Weight	750 g (1.65 lb) without batteries
Meter enclosure	IP54 with battery cover in place (resistant to intrusion of dust and water spray)
Power requirements (internal)	AA Alkaline or rechargeable Nickel Metal Hydride (NiMH) batteries (4); battery life: up to 200 hours
Power requirements (external)	Class II, external power adapter: 100–240 VAC, 50/60 Hz input; 4.5 to 7.5 VDC (7 VA) output
Meter protection class	Class I
Storage temperature	–20 to +60 °C (–4 to +140 °F)
Operating temperature	5 to 45 °C (41 to 113 °F)
Operating humidity	90% (non-condensing)
5-pin input connector	M12 connector for IntelliCAL™ probes
Data memory (internal)	500 results
Data storage	Automatic in Press to Read mode and Interval Mode. Manual in Continuous Read Mode.
Data export	USB connection to PC or USB storage device (limited to the storage device capacity). Transfer entire data log or as readings are taken.
Connections	Integrated USB type A (for USB 2.0 flash memory device, printer, keyboard) and Integrated USB type B (for PC)
Temperature correction	Off, automatic and manual (parameter dependent)
Measurement display lock	Continuous measurement, Interval or Press to Read mode. Averaging function for LDO probes.
Keyboard	External PC keyboard connector with USB/DC adapter

General information

In no event will the manufacturer be liable for direct, indirect, special, incidental or consequential damages resulting from any defect or omission in this manual. The manufacturer reserves the right to make changes in this manual and the products it describes at any time, without notice or obligation. Revised editions are found on the manufacturer's website.

Safety information

NOTICE

The manufacturer is not responsible for any damages due to misapplication or misuse of this product including, without limitation, direct, incidental and consequential damages, and disclaims such damages to the full extent permitted under applicable law. The user is solely responsible to identify critical application risks and install appropriate mechanisms to protect processes during a possible equipment malfunction.

Please read this entire manual before unpacking, setting up or operating this equipment. Pay attention to all danger and caution statements. Failure to do so could result in serious injury to the operator or damage to the equipment.

Make sure that the protection provided by this equipment is not impaired. Do not use or install this equipment in any manner other than that specified in this manual.

Use of hazard information

▲ DANGER

Indicates a potentially or imminently hazardous situation which, if not avoided, will result in death or serious injury.

▲ WARNING

Indicates a potentially or imminently hazardous situation which, if not avoided, could result in death or serious injury.

▲ CAUTION



Indicates a potentially hazardous situation that may result in minor or moderate injury.

NOTICE

Indicates a situation which, if not avoided, may cause damage to the instrument. Information that requires special emphasis.

Precautionary labels

Read all labels and tags attached to the instrument. Personal injury or damage to the instrument could occur if not observed. A symbol on the instrument is referenced in the manual with a precautionary statement.

	This symbol, if noted on the instrument, references the instruction manual for operation and/or safety information.
	This symbol indicates that the marked item can be hot and should not be touched without care.
	Electrical equipment marked with this symbol may not be disposed of in European domestic or public disposal systems. Return old or end-of-life equipment to the manufacturer for disposal at no charge to the user.

Product overview

The HQd series laboratory meters are used with digital IntelliCAL™ probes to measure various parameters in water. The meter automatically recognizes the type of probe that is connected to the meter. Measurement data can be stored and transferred to a printer, PC or USB storage device (Refer to [Figure 1](#)).

The HQd series meters are available in 3 models:

- HQ411d—pH/mV/ORP (Redox)
- HQ430d—Multi-parameter, single probe input
- HQ440d—Multi-parameter, dual probe inputs

Features common to all models:

- Automatic probe and parameter recognition
- Instrument guided calibration procedures
- Calibration data stored in the probe
- Probe specific method settings for regulatory compliance and Good Laboratory Practice (GLP)
- Security Options
- Real-time data logging with a USB connection
- USB connectivity to PC/printer/USB storage device/keyboard
- Bi-directional communication with PC-based systems with a virtual serial port connection

- Sample ID and Operator ID for data traceability
- Adjustable automatic shut-off

Figure 1 Product overview

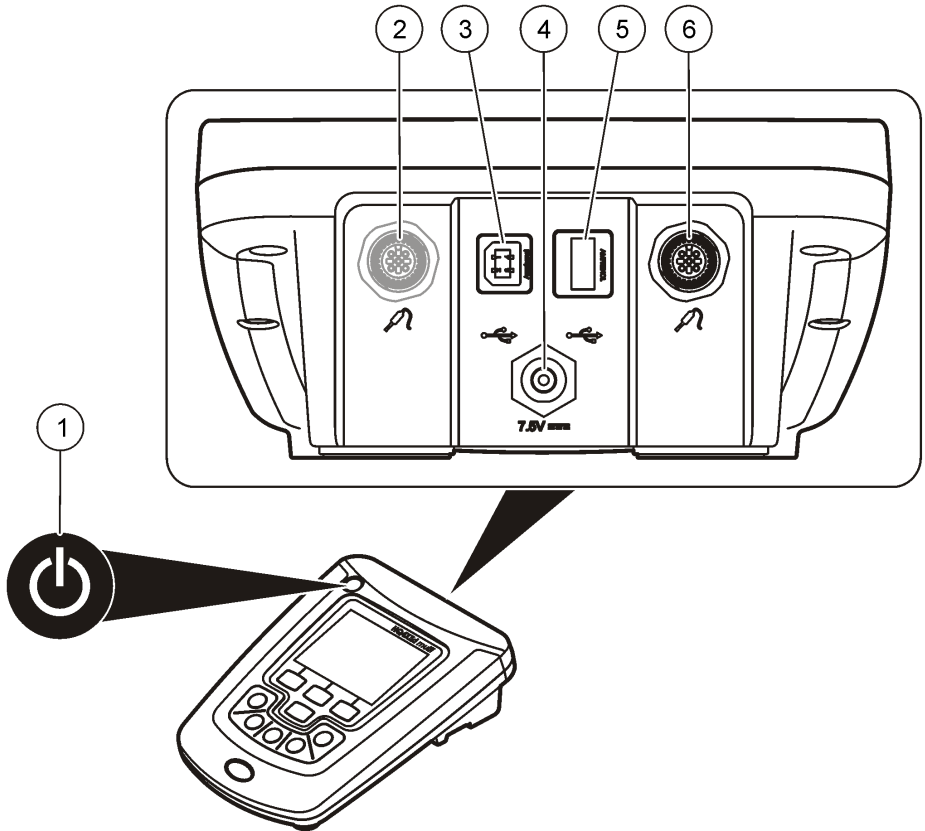

1 ON/OFF: turn on or turn off the meter	4 DC power connector
2 Probe connection port (HQ440d model)	5 USB connector type A (for USB storage device, printer and keyboard)
3 USB connector type B (for PC connections)	6 Probe connection port

Product components

Refer to [Figure 2](#) to make sure that all components have been received. If any items are missing or damaged, contact the manufacturer or a sales representative immediately.

Figure 2 Meter components

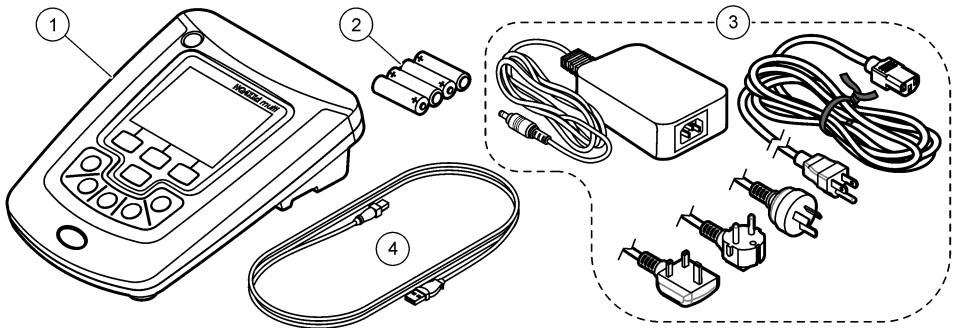

1 HQ440d, HQ430d or HQ411d meter	3 AC/DC power supply with cable
2 AA batteries (pk/4)	4 USB cable (HQ440d, HQ430d models only)

Installation

⚠ CAUTION



Multiple hazards. Only qualified personnel must conduct the tasks described in this section of the document.

Connect to AC power

⚠ DANGER



Electrocution Hazard. AC power outlets in wet or potentially wet locations MUST ALWAYS be provided with a Ground Fault Circuit Interrupting (GFCI/GFI) circuit breaker. The AC-DC power adapter for this product is not sealed and must not be used on wet benches or in wet locations without GFCI protection.

The meter can be powered by AC power with the universal power adapter.

1. Set the meter to OFF.
2. Connect the AC/DC power supply to the meter. Refer to [Figure 3](#).
3. Connect the AC/DC power supply to an AC receptacle.
4. Set the meter to ON.

Figure 3 AC power connection

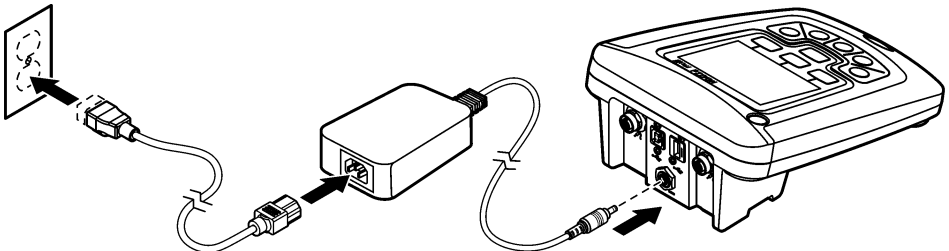

Install the batteries

⚠ WARNING

Explosion hazard. Incorrect battery installation can cause the release of explosive gases. Be sure that the batteries are of the same approved chemical type and are inserted in the correct orientation. Do not mix new and used batteries.

NOTICE

The battery compartment is not waterproof. If the battery compartment becomes wet, remove and dry the batteries and dry the interior of the compartment. Check the battery contacts for corrosion and clean them if necessary.

NOTICE

When using nickel metal hydride (NiMH) batteries, the battery icon will not indicate a full charge after freshly charged batteries have been inserted (NiMH batteries are 1.2 V versus 1.5 V for alkaline batteries). Even though the icon does not indicate complete charge, 2300 mAh NiMH batteries will achieve 90% of instrument operation lifetime (before recharge) versus new alkaline batteries.

NOTICE

To avoid potential damage to the meter from battery leakage, remove the meter batteries prior to extended periods of non-use.

The meter can be powered with AA alkaline or rechargeable NiMH batteries. To conserve battery life, the meter will power off after 5 minutes of inactivity. This time can be changed in the Display Options menu.

For battery installation refer to [Figure 4](#).

1. Loosen the three battery cover screws and remove the battery cover.

Note: Do not remove the screws from the battery cover.

2. Install 4 AA alkaline or 4 AA nickel metal hydride (NiMH) batteries. Make sure that the batteries are installed in the correct polarity.
3. Replace the battery cover.

Note: Do not over-tighten the screws.

Figure 4 Battery installation

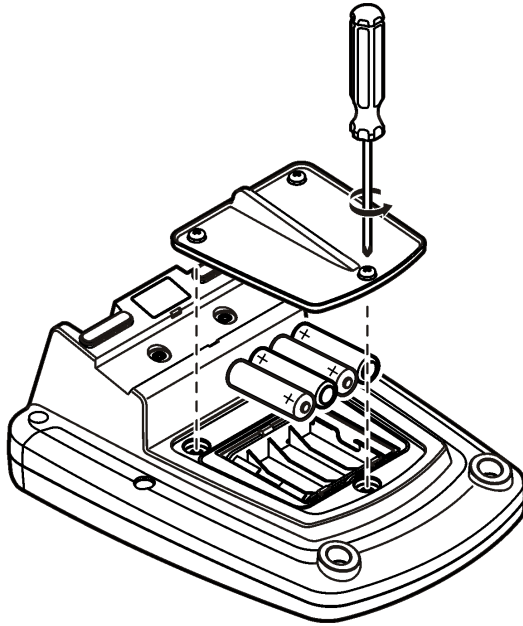

User interface and navigation

User interface

Figure 5 Keypad description

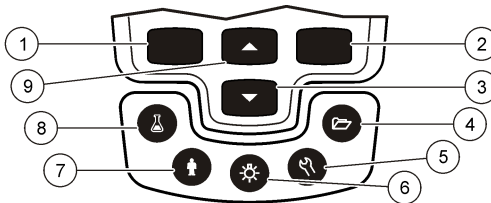

1 LEFT key: calibrates, cancels or exits the current menu	6 BACKLIGHT: turn off display illumination
2 RIGHT key: reads, selects, confirms or stores data	7 OPERATOR ID: associate data with an individual
3 DOWN key: scroll through menus, enter numbers/letters or change the reading screen view	8 SAMPLE ID: associate data with a sample location
4 DATA LOG: recall or transfer stored data	9 UP key: scroll through menus, enter numbers and letters or change the reading screen view
5 METER OPTIONS: change settings, run check standards, view meter information	

Display description

Measurement screen

The meter display shows the concentration, units, temperature, calibration status, operator ID, sample ID, date and time (Figure 6).

Figure 6 Single screen display

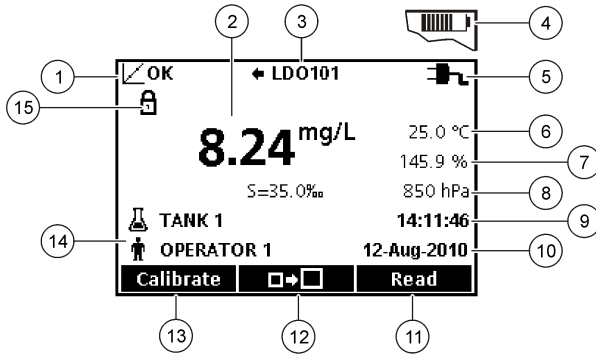

1 Calibration status indicator	9 Time
2 Main measurement value and unit	10 Date
3 IntelliCAL probe type and port indicator	11 Read (OK, Select)
4 Battery status	12 Display size icon
5 Power source	13 Calibrate (Cancel, Exit)
6 Sample temperature (°C or °F)	14 Sample and operator identification
7 Secondary measurement unit	15 Stability or display lock indicator
8 Tertiary units (for some probes)	

Big-screen mode

The font size of the sample reading can be increased or decreased with the \triangle key (Figure 7).
Note: \triangle When two probes are connected, push and hold the key to select the big-screen mode. The big-screen mode can also be selected in the Display Options menu (Refer to [Set the display options](#) on page 21).

Figure 7 Single-screen display—big-screen mode

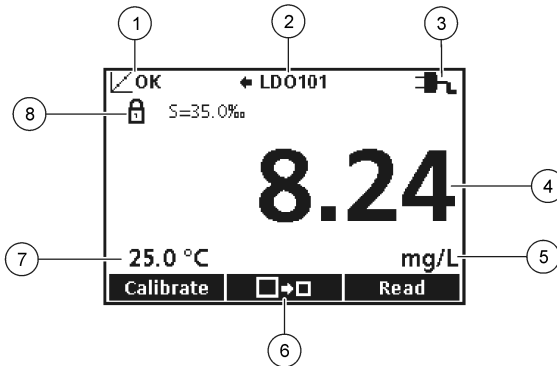

1 Calibration status indicator	5 Main measurement unit
2 IntelliCAL probe type and port indicator	6 Display size icon
3 Power source or battery status	7 Sample temperature (°C or °F)
4 Main measurement value	8 Stability or display lock indicator

Dual-screen mode (HQ440d model only)

When two probes are connected to the HQ440d meter, the display can show the reading from both probes simultaneously or show just one probe (Figure 8).

Note: For probe calibration, change the screen mode to the single screen mode.

To change the screen mode to single or dual screen, use the \triangle and ∇ keys. In dual screen mode, the \triangle key will select the probe on the left and the ∇ key will select the probe on the right.

Figure 8 Dual-screen display

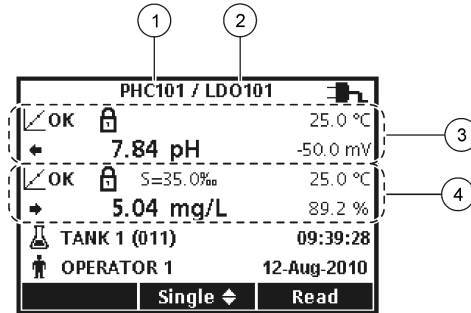

1 Probe that is connected to port on left	3 Measurement information for probe on left
2 Probe that is connected to port on right	4 Measurement information for probe on right

Navigation

The meter contains menus to change various options. Use the \triangle and ∇ keys to highlight different options. Push the RIGHT key to select an option. There are two ways to change options:

1. Select an option from a list: Use the \triangle and ∇ keys to select an option. If check boxes are shown, more than one option can be selected. Push the LEFT key under Select.

Note: To deselect check boxes, push the LEFT key under Deselect.
2. Enter an option value using the arrow keys: Push the \triangle and ∇ keys to enter or change a value.
3. Push the RIGHT key to advance to the next space.
4. Push the RIGHT key under OK to accept the value.

Startup

Turn the meter on and off

Push the \odot key to turn on or turn off the meter. If the meter does not turn on, make sure that the AC power supply is properly connected to an electrical outlet or that the batteries are properly installed.

Change the language

The display language is selected when the meter is powered on for the first time. The language can also be changed from the Meter Options menu.

Access to the language menu can be restricted with the Security Options. Refer to [Security options](#) on page 18.

1. Push the Ⓜ key and select Language.
2. Select a language from the list.

Note: While turning the meter on, the language can also be changed when the power key is pushed and held.

Change the date and time

The date and time can be changed from the Date & Time menu.

1. Push the  key and select Date & Time.
2. Update the time and date information:

Option	Description
Format	Select one of the formats below for the date and time. Use the \triangle and ∇ keys to select from the format options. dd-mm-yyyy 24h dd-mm-yyyy 12h mm/dd/yyyy 24h mm/dd/yyyy 12h dd-mmm-yyyy 24h dd-mmm-yyyy 12h yyyy-mm-dd 24h yyyy-mm-dd 12h
Date	Use the \triangle and ∇ keys to enter the current date.
Time	Use the \triangle and ∇ keys to enter the current time.

The current date and time will be shown on the display.

Connect a probe after the date and time setup, so that the meter is ready to take a measurement.

Connect a probe

1. Make sure that the display shows the current time and date.
Note: The time stamp for a probe is set when the probe is first connected to the meter. This time stamp makes it possible to record the probe history and record the time when measurements are made.
2. Plug the probe into the meter ([Figure 9](#)).
3. Push and turn the locking nut to tighten.

Figure 9 Probe connection

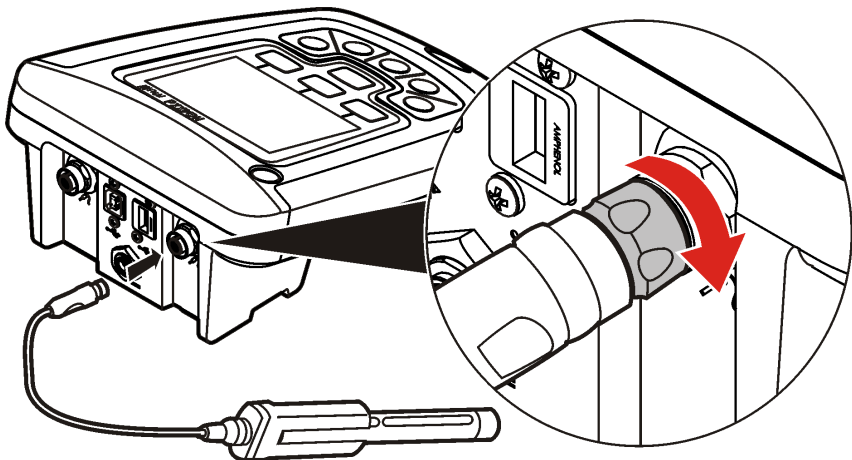

Standard operation

About calibration

Each probe uses a different type of calibration solution. Make sure to calibrate the probes frequently to maintain the highest level of accuracy.

Note: For step-by-step instructions, refer to the documents that are included with each probe.

The calibration icon  can indicate that:

- the calibration timer has expired
- the LDO sensor cap should be replaced
- the calibration is out of range
- the calibration results are outside acceptance criteria settings

About sample measurements

Each probe has specific preparation steps and procedures for taking sample measurements. For step-by-step instructions, refer to the documents that are included with the probe.

About check standards

Run Check Standards verifies equipment accuracy by measuring a solution of a known value. The meter will indicate if the Check Standard passed or failed. If the Check Standard fails, the calibration icon  is shown until the probe is calibrated.

The meter can be set to automatically show a reminder for check standard measurement at a specified interval with a specified acceptance criteria. The reminder, value of the check standard, and acceptance criteria can be changed. For step-by-step instructions, refer to the documents that are included with the probe.

Use a sample ID

The sample ID tag is used to associate measurements with a particular sample location. If assigned, stored data will include the sample ID.

1. Push the  key.
2. Select, create or delete a sample ID:

Option	Description
Current ID	Select an ID from a list. The current ID will be associated with sample data until a different ID is selected.
Create a New Sample ID	Enter a name for a new sample ID.
Delete Sample ID	Delete an existing sample ID.

Use an operator ID

The operator ID tag associates measurements with an individual operator. All stored data will include the operator ID.

1. Push the  key.
2. Select, create or delete an operator ID:

Option	Description
Current ID	Select an ID from a list. The current ID will be associated with sample data until a different ID is selected.

Option	Description
Create a New Operator ID	Enter a name for a new operator ID (maximum 10 names can be entered).
Delete Operator ID	Delete an existing operator ID.

Data management

About stored data



The following types of data are stored in the data log:

- **Sample measurements:** stored automatically each time a sample is measured in the Press to Read or Interval Mode. When the continuous measurement mode is used, data is stored only when Store is selected.
- **Calibrations:** stored only when Store is selected at the end of a calibration. Calibration data is also stored in the IntelliCAL (R) probe.
- **Check standard measurements:** stored automatically each time a check standard is measured (in the Press to Read or Interval Mode).

When the data log becomes full (500 data points), the oldest data point is deleted when a new data point is added. The entire data log can be deleted to remove data that has already been sent to a printer or PC ( key > Delete Data Log). To prevent deletion of the data log by a user, use the Security Options menu.

View stored data

The data log contains sample, calibration and check standard data. The most recent data point in the data log is tagged as Data Point 001.

1. Push the  key.
2. Select View Data Log to view the stored data. The most recent data point is shown. The top of the screen shows whether the data is from a sample reading, a calibration or a check standard. Push the  key to view the next most recent data point.

Option	Description
Reading Log	Reading Log—shows sample measurements including the time, date, operator and sample ID. Select Details to view the associated calibration data.
Calibration Log	Calibration Log—shows calibration data. Select Details to view additional information about the calibration.
Check Standard Log	Check Standard Log—shows check standard measurements. Select Details to view the calibration data that was associated with the measurement.

View stored probe data

Make sure that a probe is connected to the meter. If two probes are connected, select the appropriate probe when prompted.

1. To view the calibration data that is stored in a probe, push the  key and select View Probe Data. The current calibration and calibration history for the probe can be viewed.

Option	Description
View Current Calibration	The current calibration information shows the calibration details for the most recent calibration. If the probe has not been calibrated by the user, the factory calibration data is shown.
View Calibration History	The calibration history shows a list of the times when the probe was calibrated. Select a date and time to view a summary of the calibration data.

Print stored data

The meter must connect to AC power to start the USB connection. Make sure that the connection to AC power is made before the meter is powered on.

All data can be sent to a printer. Compatible printers should support a minimum of 72 columns of data, be capable of printing up to 500 continuous data-stream events in 1, 2 and 3 lines of text and fully support code page 437 and code page 850.

1. Turn off the meter. Make sure that the meter is connected to AC power. Refer to [Connect to AC power](#) on page 6.
2. Connect the printer to the meter with a USB cable type A. Refer to [Figure 10](#).
3. Turn on the meter.
4. Push the  key.
5. Select Send Data Log. Wait for the display to show "Transfer Complete" and wait for the printer to stop printing. Disconnect the printer.

Figure 10 Connection to the printer



1 USB cable	3 AC-DC power supply for printer (optional)
2 Printer, FCC Part 15B, Class B compliant	

Change the report options

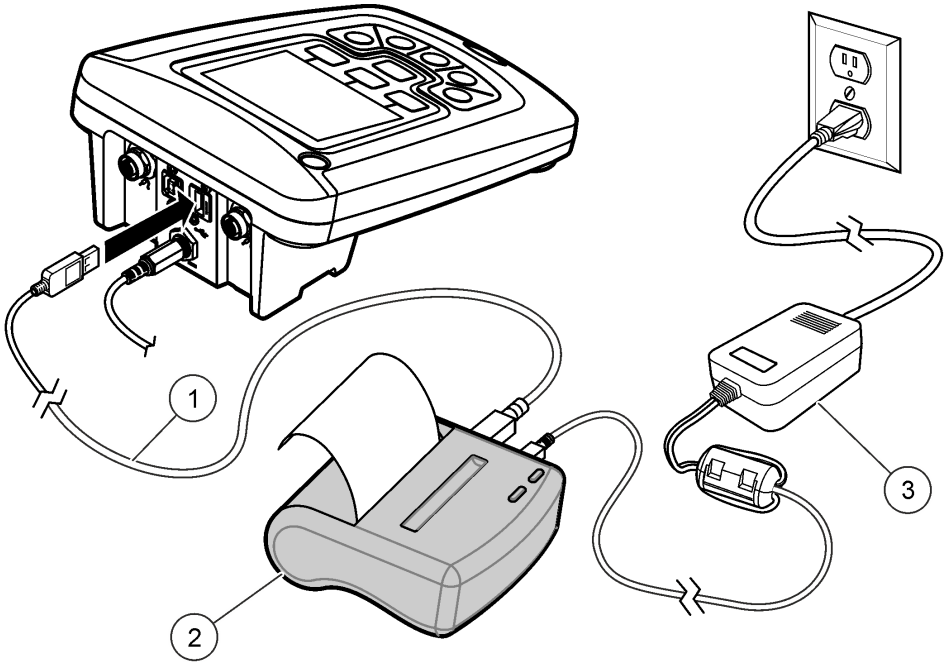
Printed reports for sample data can contain 1, 2 or 3 lines of information. Refer to [Examples of printed reports](#) on page 29 for further information.

1. Push the  key. Select Report Options.
2. Select Report Type and select one of the options.

Option	Description
Basic report	One line of data.
Advanced report	Two lines of data. The first line contains the same information as in the basic report.
Total report	Three lines of data. The first two lines contain the same information as in the advanced report.

Send data to a USB storage device

NOTICE

The transfer of a large number of data points will take some time. DO NOT disconnect the USB storage device until the transfer is complete.

Data can be transferred to a USB storage device for storage or transfer to a computer.

1. Turn off the meter. Make sure that the meter is connected to AC power.
2. Plug the USB storage device into the meter before the meter is powered on.

3. Turn on the meter.
4. Push the  key.
5. Select Send Data Log. Wait for the display to show “Transfer Complete” and for any lights on the USB storage device to stop flashing. Then remove the USB device.

Note: If the data transfer is slow, reformat the USB storage device to use the file allocation table (FAT) format for the next use.

Open data files on a PC

Data that has been downloaded to a USB storage device can be transferred to a computer. The data is sent in a text (.txt) file format.

1. Plug the USB storage device into the computer.
2. Find the data file. The file will have the following format: “Meter Serial Number-Data File Type-Date Time”. Example: 9999NN000000-SENDDATA-0603131624.TXT
3. Save the data file to a location on the computer.
4. Open a spreadsheet program such as Microsoft® Excel® spreadsheet software.
5. Open the data file from the spreadsheet program. Select the delimited option with comma as the delimiter.

The data will be shown in the spreadsheet program.

Note: If an application is used that is not compatible with column headings, the headings can be omitted. Refer to [Remove column headers](#) on page 18.

Data file description

Data that is saved to a USB storage device and then opened in a spreadsheet application will have multiple columns of data. A description for each of the columns is shown in [Table 1](#).

Table 1 Spreadsheet column descriptions

Column header name	Data description and example values
Type	Type of data: RD = Reading; CL = Calibration; CK = Check Standard; CH = Calibration History; IC = Current Calibration
Parameter	Type Parameter: LDO, pH, CD (conductivity), ORP, ISE
Date	Date of reading: stored in user-defined date format
Time	Time of reading: stored in user-defined format
Operator ID	Operator ID that was used when the data was recorded. Shows “- - -” if no operator ID is used.
Probe Model	Model number of probe, for example pHC101, CDC401, LDO101
Probe SN	Probe serial number If two probes are connected to the HQ440d meter, the serial number shows “<” or “>” to identify the port (left or right) the probe was connected to during the reading.
Method name	User-defined name of the probe settings that were used for the reading.
Sample ID	Sample ID that was used when the data was recorded. Shows “Sample ID” if the default sample ID is used.
Primary Reading Value	Measured value. Shows “—” if the value was out of range.
Primary Reading Units	Measurement units, for example pH or µS/cm
Supp Reading 1	First supplemental reading (example: temperature), if applicable
Supp Units 1	Units for first supplemental reading, if applicable.
Supp Reading 2	Second supplemental reading (example: “mV” for pH), if applicable

Table 1 Spreadsheet column descriptions (continued)



Column header name	Data description and example values
Supp Units 2	Units for second supplemental reading, if applicable
Supp Reading 3	Third supplemental reading, if applicable
Supp Units 3	Units for third supplemental reading, if applicable.
Reading Setting 1–4	Any settings that affect the reading, for example “NaCl/Non-Linear”
Any settings that affect the reading, for example “NaCl/Non-Linear”	Reading Message 1–4 Any message that was shown during the measurement, for example “Out of limits”.
Check Std Value	Value of the check standard that was used to verify accuracy, for example: 7.00 pH–25 °C (pH, temp-compensated); 7.01 pH (pH, custom)
Check Std Units	Check standard units, for example $\mu\text{S}/\text{cm}$. <i>Note: pH is not displayed here as it is included in the previous column.</i>
Check Std Graph	Bar-graph showing the measurement in relation to the acceptance limits. Example: “6.901 <— —> 7.101”.
Check Std Status	Status of the check standard reading. Example: “Reading within limits”, “Reading outside limits”
Calibration Status	Status of the calibration that is in use.  = current calibration is valid;  = calibration has expired.
Cal Date	Date of calibration reading: stored in user-defined date format
Cal Time	Time of calibration reading: stored in user-defined time format
Cal Operator ID	The operator ID specified when the probe was calibrated. Shows “- - -” if undefined.
Cal Slope Name	Slope (pH or LDO) or cell constant (conductivity)
Cal Slope	The slope value for the calibration
Cal Slope Aux	Used by pH to give the percent of nominal slope
Cal Slope Units	Units of the calibration slope. Example: “mV/pH” for pH
Cal Offset	Calibration offset value
Cal Offset Units	Calibration offset units. Example: “mV” for pH.
Cal r ²	Calibration correlation coefficient without a unit (may be blank)
Cal Number of Std's	Number of standards used during calibration, for example 5. May be blank depending on record type, parameter type, and method settings.
Cal Std 1	Known value of the first calibration standard
Cal Std 1 Units	Units of the first calibration standard
Cal Std 1 Primary Value	Measured value of the first calibration standard
Cal Std 1 Primary Units	Associated units for the calibration measurement
Cal Std 1 Supp Value	Value of supplemental measurement, for example temperature
Cal Std 2–7	Known value of additional calibration standards, if used
Cal Std 2–7 Units	Units of additional calibration standards, if used
Cal Std 2–7 Primary Value	Measured values of additional calibration standards, if used
Cal Std 2–7 Primary Units	Associated units for additional calibration measurements, if used

Table 1 Spreadsheet column descriptions (continued)

Column header name	Data description and example values
Cal Std 2–7 Supp Value	Value of supplemental measurement, for example temperature
Cal Std Supp Units	Units applicable to all secondary calibration readings. Example: “°C” or “°F” for temperature
Cal Message 1–4	Any messages about the calibration
Date/Time POSIX	Date and time of reading stored in POSIX format (number of seconds from January 1, 1970) Example: 1149234913
Cal Date/Time POSIX	Date and time of calibration stored in POSIX format (number of seconds from January 1, 1970). Example: 1111320348
Meter SN	Meter serial number used to take the measurement

Remove column headers

When transferred data is viewed in a spreadsheet program, the first row of data contains headings to identify the type of data in each column. If an application or post-processing method is used that is incompatible with the headers, the column headers can be omitted.

1. Push the  key.
2. Select Column Headers.
3. Set the column headers to off.

Send data directly to a computer

Data can be transferred from any HQd series meter directly to a computer when the HQ40d PC Application is installed. The data can be sent in real time during data collection, or the entire data log can be transferred.

To download the most current version of the software, refer to the applicable product page on the manufacturer's website.

1. Install the HQ40d PC Application on the computer.
2. Turn off the meter. Make sure that the meter is connected to AC power.
3. Connect the PC to the meter with a USB type B cable.
4. Turn on the meter.
5. Open the HQ40d PC Application on the computer. Click on the green triangle in the menu bar to start a connection.
6. Collect the data in real time or transfer the data from the data log:
 - Real time—when a data point is stored in the meter, the result is sent simultaneously to the PC Application (refer to [Set the measurement mode](#) on page 22).
 - Data log—push the  key and select Send Data Log. Wait for the display to show “Transfer Complete.” The data is sent as a comma separated values (.csv) file.

The data is shown in the HQ40d PC Application window.

Advanced operation

Security options

The Security Options menu is used to protect the meter setup and method settings from unwanted changes. This menu is available in the Full Access Options menu.

The Setup Measurement Mode, Date and Time, Temperature Units, Language, Probe settings, Delete data log and Security Options screens are disabled in the Operator Access Options menu. All menu options are enabled in the Full Access Options menu.

Note:  The Full Access Options menu is shown when the key is pushed when Security Options is OFF, whether or not a password has been set.

When the meter is powered on for the first time and Security Options is selected, the display prompts the user to set a password. Until the meter is shut off, pushing the  key will still display the Full Access Options menu, even after Security Options is turned on and a password has been set. After the meter is shut off and powered on again with Security Options on, the Operator Access Options menu is displayed until a valid password is entered.

Store the password in a safe and accessible place. If the specified password is forgotten and Security Options is turned on, the operator is locked out of the restricted menus. Contact technical support if the password is lost.

Turn Security Options on

The Security Options and the Set Password options are used together to prevent access to restricted menus.

1. Push the  key and select Security Options.
2. Change the settings as needed to allow or prevent menu access.

Option	Description
Security Options	When Security Options is on, and a password has been specified, the password is required to enable the Full Access Options menu. If the meter is turned off while Security Options is on, the password is required to enable the Full Access Options menu again when the meter is turned on.
Set Password	Set a password that must be entered to enable the Full Access Options menu. The requirement for password entry is controlled by setting Security Options on or off.

Full access options menu

The Full Access Options menu is displayed when Security Options is OFF or when Security Options is ON and a valid password is entered (Table 2). These options do not need to be changed if the factory default settings are used.

Table 2 Full Access Options

Option	Description
(Probe model) settings	Settings such as measurement options, calibration options, check standard options, units and resolution. Refer to the probe documentation for more information. Note: A probe must be connected to the meter.
Run check standard	Measure standard solution (available for pH, conductivity, ORP and ISE probes)
Measurement mode	Press to Read
	Interval: Duration and Interval
	Continuous
Instrument information	Probe information
	Meter information
Security options	ON or OFF
	Set password

Table 2 Full Access Options (continued)

Option	Description
Display options	Contrast
	Auto shutoff
	Backlight
	Mode
Sounds	Key press
	Stability alert
	Calibration reminder
Date and time	Format
	Date
	Time
Temperature units	Set temperature units
Language	Select language

Restricted operator access options menu

The Operator Access Options menu is shown at meter startup when Security Options is ON ([Table 3](#)). When a valid password is entered, the menu changes to Full Access Options.

Table 3 Operator access options

Option	Description
(Probe model) settings	Only methods (if methods exist) can be selected. Refer to the probe documentation. <i>Note: A probe must be connected to the meter.</i>
Run check standard	Measure standard solution (available for pH, conductivity, ORP and ISE probes) <i>Note: A probe must be connected to use this option.</i>
Instrument information	Probe information
	Meter information
Access password	Enter password
Display options	Contrast
	Auto shutoff
	Backlight
	Mode
Sounds	Key press
	Stability alert
	Calibration reminder

Set the display options

Use Display Options to change the display contrast, battery saving auto-shutoff options, the backlight option or the detailed or big reading screen mode.

1. Push the  key and select Display Options.
2. Select which display option to change.

Option	Description
Contrast	Adjust the contrast of the display. The lightest setting is 0 and the darkest setting is 9.
Auto-shutoff	To maximize battery life, set a time period after which the meter will automatically power off if no key is pushed (1, 2, 5, 10, 30 min, 1 h, 2 h or never). Auto-shutoff is not active when the meter is connected to AC power or in the Interval Reading Mode.
Backlight	The display backlight is turned off when the  key is pushed. Is it possible to set a time period after which the backlight will automatically power off if no key is pushed.
Mode	Select Detailed or Big screen size. Detailed will show more information with smaller numbers and text. Big will show less information with larger numbers and text. Note: <i>The screen size can also be selected from the measure mode (refer to Display description on page 8).</i>

Set the sound options

The meter can make an audible sound when a key is pushed, when stability is reached or when the calibration reminder is due. The meter also makes an audible sound when it begins transferring data to a USB storage device and again when the data transfer is complete.

1. Push the  key and select Sound.
2. Choose which events will produce an audible sound. Multiple items can be selected.

Option	Description
Key Press	The meter will make an audible sound whenever a key is pushed.
Stability Alert	The meter will make an audible sound whenever measurement stability is reached.
Cal reminder	The meter will make an audible sound when calibration is due. Note: <i>Refer to Set the probe calibration reminder on page 21 to set the calibration reminder to on or off.</i>

Set the probe calibration reminder

Make sure that a probe is connected to the meter.

1. Push the  key and select the probe settings.
2. Select Modify Current Settings.
3. Select Calibration Options.
4. Select Calibration Reminder.

Option	Description
Calibration reminder	Reminder repeat: Off, 2 h, 4 h, 8 h, 2 d, 5 d, 7d Expires: Immediately, Reminder + 30 min, Reminder + 1 hr, Reminder + 2 hr, Continue Reading The meter can be set to make an audible sound when calibration is due. Calibration expires after a specified time set by the user. Note: <i>The meter cannot be used to read samples after calibration has expired unless Continue Reading is selected.</i>

Change the temperature units

To select degrees Celsius or Fahrenheit:

1. Push the  key and select Temperature Units.
2. Select the Celsius or Fahrenheit option.

Set the measurement mode

One of three modes can be used to specify when measurements are taken and how the data is stored. When a data point is stored, the result is sent simultaneously to any device (PC/printer/ USB storage device) that is connected to the meter.

1. Push the  key and select Measurement Mode.
2. Select Mode.
3. Select one of the measurement modes.

Option	Description
Press to Read	The sample is measured only when the RIGHT key under Read is pushed. Data is stored in the data log automatically when the stability criteria are met.
Interval	The sample is measured at regular intervals for a specified duration (refer to Set auto measurement intervals on page 22). Data is stored in the data log automatically.
Continuous	The sample is measured continuously. Data is stored in the data log only when the RIGHT key under Store is pushed.

Set auto measurement intervals

When the measurement mode is set to Interval, the time intervals and duration must be specified. Measurements are stored at the user-defined intervals whether or not stability criteria are met.

Note: Use of an external USB storage device or direct printer connection while in Interval Measurement mode prevents data from being over-written in the data log. Data points are over-written on a First In/First Out basis. Refer to [Prevent data log overflow in interval mode](#) on page 23.

1. Push the  key and select Measurement Mode.
2. Select Mode.
3. Select Interval as the Measurement Mode.
4. Select Duration and select the total time that measurements will be taken for (15 min, 30 min, 1 h, 4 h, 8 h, 24 h, 48 h or no limit).
5. Select Interval and select how often measurements will be taken (every 10 s, 30 s, 1 min, 5 min, 15 min or 30 min).

Start interval measurements

During interval measurements, the meter goes into a standby state between readings to conserve power. The auto-shutoff option is disabled. Measurements stop when the selected interval duration has passed. The auto-shutoff option then becomes active.

Interval measurements are suspended for calibrations, check standard measurements or when the  key is pushed. Interval measurements resume when returning to the measurement screen.

1. From the Main Measurement screen, select Start to begin interval measurements. The screen will show "Recording" and the remaining time of the duration. The sample number automatically advances when each reading is taken.
2. To stop interval measurements, select Stop.
3. To repeat the interval measurement after it has been stopped or completed, select Start.

Prevent data log overflow in interval mode

When measurements are taken at specified intervals (Table 4), each result is automatically stored. The meter can store up to 500 data records. When 500 records have been stored, data is replaced on a first-in, first-out basis. To prevent loss of data, connect the meter to a PC/printer/USB storage device.

Note: Stop interval measurements before changes are made to a method or to meter settings.

Table 4 Recommended interval/duration pairs

Interval	Duration
10 seconds	1 hour
30 seconds	4 hours
1 minute	8 hours
5 minutes	24 hours

Note: When 2 probes are connected to the meter, use the next lowest recommended duration time. For example, for a 30-second interval, set the duration to 1 hour to prevent data log overload with 2 probes.

View instrument information

The instrument information menu shows specific information such as the serial number for the meter or IntelliCAL (R) probe(s).

1. Push the  key and select Instrument Information.
2. Select (Probe model) Information or Meter Information.

Option	Description
Probe information	The Probe Information screen shows the probe model number, serial number, software version and date of first use. For LDO and LBOD probes, the lot code for the sensor cap and the remaining time before sensor cap replacement is shown. Note: A probe must be connected to the meter.
Meter information	The Meter Information screen shows the meter model number, serial number, software version and memory information. The amount of memory used and the number of available user method settings, operator IDs and sample IDs is shown.

Update the meter software

A USB storage device that contains software update files is used to update the meter software.

Note: The meter must be turned off and then on again before the software update will begin. The software update initiates upon meter startup after the USB device is correctly inserted.

NOTICE

Do not remove the USB device until the "Update complete" message is shown. The meter can become damaged if the USB device is removed before the update process is complete.

1. Save stored data from the data log to a USB storage device or to a PC. Refer to [Send data to a USB storage device](#) on page 15 and [Send data directly to a computer](#) on page 18.
2. Turn off the meter.
3. Connect the meter to AC power (Figure 3 on page 6).
4. Insert the USB storage device that contains the software update files into the meter.
Note: USB storage devices with enabled security protection may not operate correctly.
5. Turn on the meter.

The update process starts. The display will show “Updating meter to <firmware version>”. After an interval, the display changes to “Updating files, please wait...” In addition, the display will show a rotating flask and emit a periodic audio signal during the update process.

Note: A large capacity USB storage device increases the time required for completion of the update process, even if most of the device memory is empty.

6. Wait for the meter to finish the software update. When the update process is complete, the message “Update complete. Remove USB device” is shown. The meter will turn off after the USB device has been removed.
7. Repeat steps 1 through 6 to update the software in other HQd meters as necessary.

Download software updates

To download the most current version of the software, refer to the applicable product page on the manufacturer’s website.



1. Transfer the update files to a USB storage device.
2. Follow the instructions in [Update the meter software](#) on page 23 to update the software in the meter.

Transfer method settings

Probe settings that have been changed by the user for measurements, calibrations or check standards (Meter Options > (Probe Model) Settings > Modify Current Settings) can be copied to a USB storage device. The USB device can then be used to transfer the method settings to other HQd meters that accept the same probes.

NOTICE

Make sure the USB storage device does not contain HQd meter software update files to prevent unintentional updates.

1. Turn off the meter.
2. Connect the meter to AC power ([Figure 3](#) on page 6).
3. Insert the USB storage device.
4. Turn on the meter.
5. Push the  key and select Transfer Methods. If the USB device already contains a method settings file, an option to export or import methods is shown. Select Export Methods.
6. In the Select Methods to Export screen, select one or more methods to copy to the USB device. A check mark is shown next to each selected method.
7. Select OK. The settings are copied to the USB storage device. When complete, the Transfer Summary screen is shown.
8. Connect the AC power and USB device to a meter that will receive the method settings. Turn the meter on.
9. Push the  key and select Transfer Methods. If the USB device already contains a method settings file, an option to export or import methods is shown. Select Import Methods.
10. In the Select Methods to Import screen, select one or more methods to transfer to the meter. A check mark is shown next to each selected method.
11. Select OK. The user method settings are transferred from the USB storage device to the meter. When complete, the Transfer Summary screen is shown. Select details to view additional information about the transfer.
12. Disconnect the USB storage device from the meter.

Bi-directional Communication between the meter and a PC

For measurement automation the meter can be used to implement a command set for meter remote control or automated data transfer. The command set can be used to perform minimal configuration and to control the meter. To set up the meter for communication and control, refer to [About meter](#)

[configuration](#) on page 25. For additional information and the command set contact Technical Support.

About meter control

The virtual serial connection can be used to control meter functions from a PC. For example, the functions include starting a measurement cycle, turning off the meter and sending the entire measurement (including calibrations) to the PC or other information management system.

About meter configuration

To use the meter communication and control from the PC, an INF file must be installed.

1. The meter software must be version 2.0.0.710 or higher.
To download the most current version of the software, refer to the applicable product page on the manufacturer's website.
2. Open the Zip file.
3. Copy the INF file from the software upgrade package to a convenient location on the PC.
Note: *The INF file must be installed to use the meter manual control from a PC.*
4. Turn on the meter.
5. Push the  key and select Instrument Information.
6. Select USB Device Type and then select Virtual Serial to use the virtual serial port on the meter.
7. Push OK. The meter will automatically restart to complete the setting change.
8. Connect the meter with the USB cable to the PC and turn on the meter.
Windows XP starts the "Found New Hardware Wizard".
9. Select "No, not at this time" to the query "Can Windows connect to Windows Update to search for software?"
10. Click Next. The next wizard screen will prompt.
11. Select "Install from a list or specific location (Advanced)" to the query "What do you want the wizard to do?"
12. Click Next. The next wizard screen will prompt.
13. Select the option "Search for the best driver in these locations."
14. Uncheck the "Search removable media (floppy, CD-ROM)" option and select the "Include this location in the search:" and click the "Browse" button.
15. Select the INF folder or location and click OK.
16. Click Next. The new software will be installed.
17. Click Finish to complete the Found New Hardware Wizard for: HQd Meter - Virtual Serial Port.
18. To make sure that the installation succeeded, go to Computer Management>Device Manager>Ports. The new installed port is listed as HQd Meter - Virtual Serial Port (COM#).
19. The meter is now ready for communication with PC-based systems using the Virtual Serial port. A program interface must be developed by the user for the command set used to control the meter functions from the PC. Contact Technical Support for more information and command set documentation.

Maintenance

▲ CAUTION



Multiple hazards. Only qualified personnel must conduct the tasks described in this section of the document.

Clean the meter

The meter is designed to be maintenance-free and does not require regular cleaning for normal operation. Exterior surfaces of the meter may be cleaned as necessary.

1. Wipe the surface of the meter with a damp cloth.
2. Use a cotton-tipped applicator to clean or dry the connectors.

Replace the batteries

⚠ WARNING

Explosion hazard. Incorrect battery installation can cause the release of explosive gases. Be sure that the batteries are of the same approved chemical type and are inserted in the correct orientation. Do not mix new and used batteries.

For battery replacement, refer to [Figure 11](#).

1. Loosen the three battery cover screws and remove the battery cover ([Figure 11](#)).
Note: Do not remove the screws from the battery cover.
2. Remove the batteries.
3. Install 4 AA alkaline or 4 AA nickel metal hydride (NiMH) batteries. Make sure that the batteries are installed in the correct polarity.
4. Replace the battery cover.
Note: Do not over-tighten the screws.

Figure 11 Battery replacement

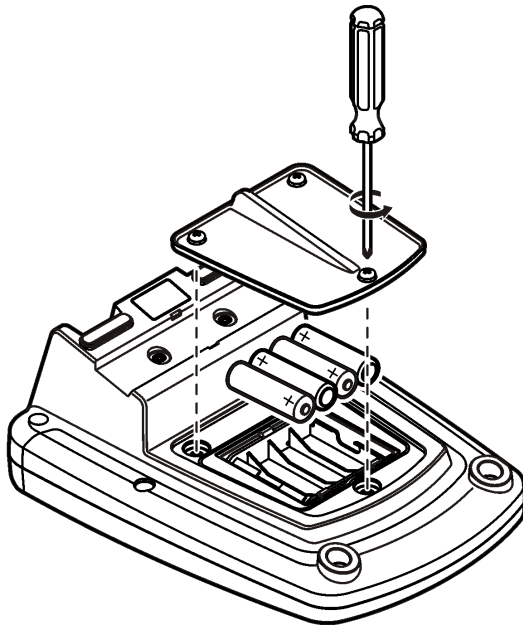

Troubleshooting

Refer to the following table for common problem messages or symptoms, possible causes and corrective actions.

Error/Warning	Description	Solution
Connect a Probe	Probe disconnected or connected improperly	Tighten the locking nut on the probe connector. Disconnect the probe and then connect the probe again
	Software not updated to most current version	To download the most current version of the software, refer to the applicable product page on the manufacturer's website.
	Problem with probe	Connect a different IntelliCAL probe to verify if problem is with probe or meter
	Probe Not Supported	Probe disconnected or connected improperly
Software not updated to most current version		To download the most current version of the software, refer to the applicable product page on the manufacturer's website.
Problem with probe		Connect a different IntelliCAL probe to the meter to verify if problem is with the meter or the probe.
HQd meter does not support IntelliCAL probe		Contact Technical Support.
Bootloader X.X.XX.XX error		Software not updated to most current version.
0 days remaining message (For LDO and LBOD only)	LDO or LBOD sensor cap used for 365 days	Replace the LDO or LBOD sensor cap and iButton®.
	There are 0 days remaining in the life of the LDO sensor cap.	Replace the LDO sensor cap. Calibration will be allowed. However, the calibration icon and question mark will appear on the measurement screen even if the calibration has passed.
	Meter set to incorrect date and time	<ol style="list-style-type: none"> 1. Disconnect the probe from the meter. 2. Remove the meter batteries. 3. Install the meter batteries properly. Follow the polarity markings. 4. Set correct date and time in the meter. 5. Connect the probe and verify that message has been removed.
	Software not updated to most current version	To download the most current version of the software, refer to the applicable product page on the manufacturer's website.
Meter not configured	Software error(s)	If the meter starts up correctly, back up the Data Log and Method files. To download the most current version of the software, refer to the applicable product page on the manufacturer's website.

Error/Warning	Description	Solution
Meter will not power on or powers on intermittently	Batteries are not installed correctly	Examine battery orientation to make sure the batteries follow the polarity markings. Test again.
		Clean the battery terminals, then install new batteries.
		Connect AC power adapter and test again.
	Software not updated to most current version	To download the most current version of the software, refer to the applicable product page on the manufacturer's website.
	Damaged meter	Contact Technical Support.
Unable to access Full Access Options screen	Correct password has not been entered	Contact Technical Support.
Unable to access Full or Operator Access Options screen	Software not updated to most current version	To download the most current version of the software, refer to the applicable product page on the manufacturer's website.

Replacement parts and accessories

Note: Product and Article numbers may vary for some selling regions. Contact the appropriate distributor or refer to the company website for contact information.

Replacement parts

Description	Item no.
Batteries, Alkaline AA	1938004
Battery cover	9245500
Cable, USB 6 ft (1.8 m), Type A male, Type B male	5924000
Power supply without power cord	5827000
Power cord, US	1801000
Power cord, EU	YAA080
Power cord, UK	XLH057
Power cord, CH	XLH051
Keyboard (QWERTY), USB type	LZV582
USB memory device with HQd Software Upgrade	5854100
USB Flash Drive, 2 GB	2946900
USB Thermal Printer Kit, DPU-S445, 100–240 V AC	US: LQV161.53.10000 EU: LQV161.99.10000
Printer paper, DPU-S445, thermal, 5/pk	5836000
Probe Clips, color coded (5 colors, 2 clips of each color), 10/pk	5818400
Universal Probe Stand for standard IntelliCAL Probes	8508850

Examples of printed reports

Printed reports contain a report header and all stored data for samples, check standards and calibrations.

Report header

The first line of a report shows the report header (Figure 12).

Figure 12 Report header

9999RV123456
-SENDDATA-0512131618
.TXT
 RD LDO 16:14:32 12-08-10 6.59 mg/L NORTH TANK -05 JOSEPH L

1 Meter serial number ¹	3 Date and time, 24 h (YYMMDDhhmm)
2 Report label	4 File type extension

Data reports

Sample data can be printed in a basic, advanced or total report format.

- Total report—refer to [Figure 13](#).
- Advanced report—refer to [Figure 14](#).
- Basic report—refer to [Figure 15](#).

Figure 13 Basic report for sample data—1 line

RD
LDO
16:14:32
12-08-10
6.59
mg/L
NORTH TANK
-05
JOSEPH L

1 Data type (RD=reading)	6 Units
2 Parameter (pH, LDO, etc.)	7 Sample ID: user-defined; shows "SAMPLE ID" if undefined
3 Time (hh:mm:ss in 24 h or user-defined format)	8 Sample ID counter
4 Date (DD-MM-YY or user-defined format)	9 Operator ID: user-defined; shows "- -" if undefined
5 Measured value	

¹ The probe serial number is shown on calibration history and current calibration reports.

Figure 14 Advanced report for sample data—2 lines

```

9999RV123456-SENDDATA-0512131618.TXT
RD LDO 16:14:32 12-08-10 6.59 mg/L PLATTE BDGE2022 JULIE
① LDO101 >52040259 24.1°C, 96.2%, 831hPa S = 0.0%
Out of limits
    
```

1 Probe model	4 Additional units: shows all additional units associated with the reading.
2 Error message (if applicable)	5 Probe settings: shows the highest-priority setting associated with the reading
3 Probe serial number (a "<" or ">" on the HQ40d meter indicates the probe position)	

Figure 15 Total report for sample data—3 lines

```

9999RV123456-SENDDATA-0512131618.TXT
RD pH 07:52:47 12-08-10 3.95 pH PLATTE BDGE2046 JULIE
pHC301 <06047527 21.8°C, 167.0mV
Default CAL12:52 12-08-10 58.36mV/pH -9.3mV MICHAEL
    
```

1 Method name for probe settings	4 Calibration slope/ratio/constant
2 Time of calibration, prefaced by "CAL" and displayed as hh:mm in 24 h (or user-defined) format	5 Offset—contents vary depending on type of parameter and user settings. May be blank.
3 Date of calibration (DD-MM-YY or user-defined format)	6 Operator ID: user-defined; shows "- - -" if undefined

Check standard reports

Check standard data is printed with 1 line of information ([Figure 16](#))

Figure 16 Check standard report

```

9999RV123456-SENDDATA-0512131618.TXT
ST pH 15:24:07 12-08-10 5.71 pH Fail GEORGE
    
```

1 Report type (ST = check standard)	5 Measured value
2 Report type (ST = check standard)	6 Units
3 Time (hh:mm:ss in 24 h or user-defined format)	7 Check standard status: Pass/Fail based on the acceptance criteria
4 Date (DD-MM-YY or user-defined format)	8 Operator ID: user-defined; shows "- - -" if undefined

Calibration reports

Calibration data is printed when the data log is sent to the printer or when probe data is sent to the printer. Calibration data is printed with 2 lines of information ([Figure 17](#)).

Figure 17 Calibration report

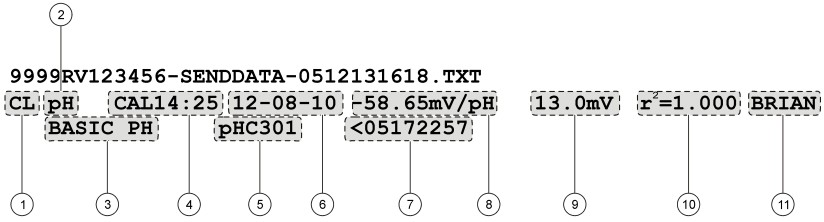

1 Report type (CL = calibration, IC = current calibration)	7 Probe serial number (a "<" or ">" on the HQ440d meter indicates the probe position)
2 Parameter (pH, LDO, etc.)	8 Calibration slope/ratio/constant
3 Method name for probe settings	9 Offset—contents vary depending on type of parameter and user settings. May be blank.
4 Time of calibration, prefaced by "CAL" and displayed as hh:mm in 24 h (or user-defined) format	10 r ² : contents vary depending on type of parameter being read, configuration of specific method and number of calibration standards used. May be blank.
5 Probe model	11 Operator ID: user-defined; shows "- -" if undefined
6 Date of calibration (DD-MM-YY or user-defined format)	

The calibration history can be printed from the probe data menu. Refer to [Figure 18](#).

Figure 18 Calibration history report

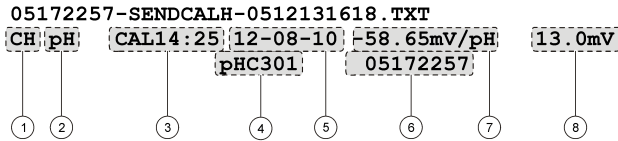

1 Report type (CH=calibration history)	5 Date of calibration (DD-MM-YY or user-defined format)
2 Parameter (pH, LDO, etc.)	6 Probe serial number (a "<" or ">" on the HQ40d meter indicates the probe position).
3 Time of calibration, prefaced by "CAL" and displayed as hh:mm in 24 h (or user-defined) format	7 Calibration slope/ratio/constant
4 Probe model	8 Offset—contents vary depending on type of parameter and user settings. May be blank.



HACH COMPANY World Headquarters

P.O. Box 389, Loveland, CO 80539-0389 U.S.A.
Tel. (970) 669-3050
(800) 227-4224 (U.S.A. only)
Fax (970) 669-2932
orders@hach.com
www.hach.com

HACH LANGE GMBH

Willstätterstraße 11
D-40549 Düsseldorf, Germany
Tel. +49 (0) 2 11 52 88-320
Fax +49 (0) 2 11 52 88-210
info-de@hach.com
www.de.hach.com

HACH LANGE Sàrl

6, route de Compois
1222 Vézenaz
SWITZERLAND
Tel. +41 22 594 6400
Fax +41 22 594 6499