



DOC022.53.80629

HQ1110, HQ1130, HQ1140, HQ2100, HQ2200, HQ4100, HQ4200, HQ4300

08/2020, Edition 1

User Manual



Section 1 Product overview	3
Section 2 Specifications	4
Section 3 General information	4
3.1 Safety information.....	5
3.2 Use of hazard information.....	5
3.3 Precautionary labels.....	5
3.4 Product components.....	6
3.5 Certification.....	6
3.6 Hach Communication Dongle (optional).....	7
3.7 Intended use.....	7
Section 4 Installation	7
4.1 Lithium battery safety.....	7
4.2 Install the battery.....	8
4.3 Charge the battery.....	8
4.4 Install the lanyard.....	11
4.5 Install the probe and USB port plugs.....	11
Section 5 Startup	12
5.1 Start the meter.....	12
5.2 Select the language.....	12
5.3 Set the date and time.....	12
5.4 Connect a probe.....	13
Section 6 User interface and navigation	13
6.1 Home screen.....	13
6.2 Keypad.....	15
6.3 Main menu.....	16
Section 7 Operation	16
7.1 Measure samples.....	16
7.2 Calibrate a probe.....	17
7.3 Verify the calibration.....	17
7.4 Include sample ID with measurement data.....	17
7.5 Include user ID with stored data.....	18
Section 8 Meter settings	18
Section 9 Probe settings	19
9.1 Change the pH settings.....	19
9.2 Change the ORP settings.....	21
9.3 Change the conductivity settings.....	22
9.4 Change the LDO or LBOD settings.....	25
9.5 Change the ISE settings.....	27
Section 10 Data management	29
Section 11 Advanced operation	30
11.1 Control access to settings.....	30
11.2 Update the meter software.....	30
11.3 View the probe information.....	31

Table of Contents

11.4 View the meter information	31
Section 12 Maintenance	31
12.1 Clean the instrument	32
12.2 Replace the battery	32
12.3 Prepare for shipping	32
Section 13 Troubleshooting	32
13.1 Use the on-screen troubleshooting instructions	32
13.2 Export a diagnostic file	32
13.3 Troubleshooting table	33
Section 14 Replacement parts	33

Section 1 Product overview

The HQ Series portable meters are used with digital Intellical probes to measure one or more water quality parameters. Refer to [Figure 1](#). The meter automatically recognizes the type of probe that is connected. The meter can connect to a PC or USB storage device to transfer data that is saved in the meter. The optional Hach Communication Dongle (HCD) connects the meter to Claros.

The HQ Series portable meters are available in eight models. [Table 1](#) shows the types of probes that can connect to each model.

Figure 1 Product overview

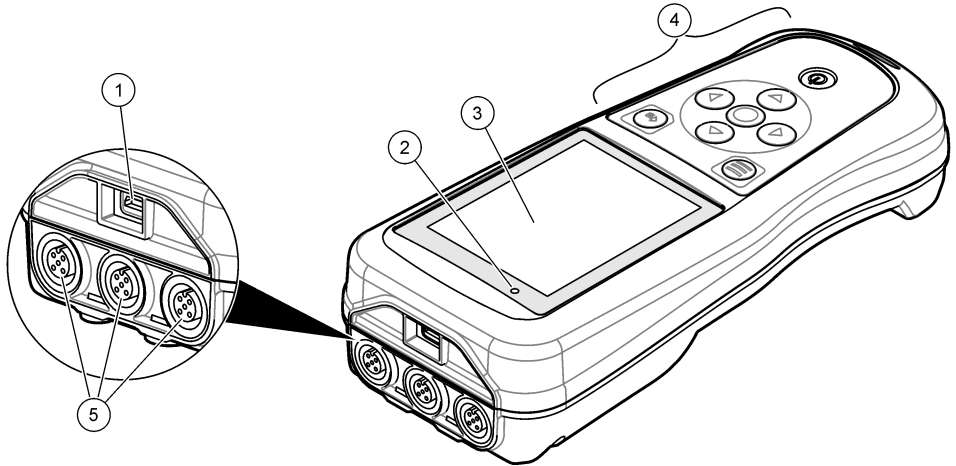

1 Micro-USB connector	4 Keypad
2 LED indicator	5 Intellical probe ports (three probe-port option shown)
3 Display	

Table 1 HQ Series meter models

Meter model	Probe connectors	pH/mV/ORP ¹ probes	LDO/LBOD ² probes	Conductivity ³ probes	ISE ⁴ probes
HQ1110	1	✓			
HQ1130	1		✓		
HQ1140	1			✓	
HQ2100	1	✓	✓	✓	
HQ2200	2	✓	✓	✓	
HQ4100	1	✓	✓	✓	✓
HQ4200	2	✓	✓	✓	✓
HQ4300	3	✓	✓	✓	✓

¹ pH/mV/ORP probes include temperature

² LDO/LBOD probes include temperature

³ Conductivity probes include salinity, TDS (total dissolved solids), resistivity, temperature

⁴ Ion-selective probes such as ammonia, nitrate, chloride, fluoride, sodium

Section 2 Specifications

Specifications are subject to change without notice.

Specification	Details
Dimensions (L x W x H)	22 x 9.7 x 6.3 cm (8.7 x 3.8 x 2.5 in.)
Weight	HQ1110, HQ1130, HQ1140 and HQ2100: 519 g (18.3 oz); HQ2200: 541 g (19.1 oz); HQ4100: 530 g (18.7 oz); HQ4200: 550 g (19.4 oz); HQ4300: 570 g (20.1 oz)
Enclosure rating	IP67 with battery compartment installed
Power requirements (internal)	Rechargeable lithium-ion battery 18650 (18-mm diameter x 65-mm length, cylindrical), 3.7 VDC, 3400 mAh; Battery Life: > 1 week with typical use (10 readings/day, 5 days/week in Continuous or Push to read mode, or > 24 hours in Interval mode with 5 minute intervals and shutdown timer ≤ 15 minutes)
Power requirements (external)	Class II, USB power adapter: 100–240 VAC, 50/60 Hz input; 5 VDC at 2 A USB power adapter output
Meter protection class	IEC Class III (SELV (Separated/Safety Extra-Low Voltage) powered); USB power adapter is IEC Class II (double-insulated)
Operating temperature	0 to 60 °C (32 to 140 °F)
Charging temperature	10 to 40 °C (50 to 104 °F)
Operating humidity	90% (non-condensing)
Storage temperature	–20 to 60 °C (–4 to 140 °F) maximum 90% relative humidity (non-condensing)
Probe connector	5-pin M12 connector for Intellical probes
Micro-USB connector	The micro-USB connector enables USB cable and USB power adapter connectivity.
Data log (internal)	HQ1000 Series: 5000 data points; HQ2000 Series: 10,000 data points; HQ4000 Series: 100,000 data points
Data storage	Automatic storage in Push to read and Interval modes. Manual storage in Continuous mode.
Data export	USB connection to PC or USB storage device (limited to the storage device capacity)
Temperature correction	Off, automatic and manual (parameter-specific)
Certifications	CE, FCC, ISED, RCM, KC, ETL Verified: US DOE/ NRCan Energy Efficiency, RoHS
Warranty	HQ1000 and HQ2000 series: 1 year (US), 2 years (EU); HQ4000 series: 3 years (US), 3 years (EU)

Section 3 General information

In no event will the manufacturer be liable for direct, indirect, special, incidental or consequential damages resulting from any defect or omission in this manual. The manufacturer reserves the right to make changes in this manual and the products it describes at any time, without notice or obligation. Revised editions are found on the manufacturer's website.

3.1 Safety information

NOTICE

The manufacturer is not responsible for any damages due to misapplication or misuse of this product including, without limitation, direct, incidental and consequential damages, and disclaims such damages to the full extent permitted under applicable law. The user is solely responsible to identify critical application risks and install appropriate mechanisms to protect processes during a possible equipment malfunction.

Please read this entire manual before unpacking, setting up or operating this equipment. Pay attention to all danger and caution statements. Failure to do so could result in serious injury to the operator or damage to the equipment.

Make sure that the protection provided by this equipment is not impaired. Do not use or install this equipment in any manner other than that specified in this manual.

3.2 Use of hazard information

▲ DANGER

Indicates a potentially or imminently hazardous situation which, if not avoided, will result in death or serious injury.

▲ WARNING

Indicates a potentially or imminently hazardous situation which, if not avoided, could result in death or serious injury.

▲ CAUTION

Indicates a potentially hazardous situation that may result in minor or moderate injury.

NOTICE

Indicates a situation which, if not avoided, may cause damage to the instrument. Information that requires special emphasis.

3.3 Precautionary labels

Read all labels and tags attached to the instrument. Personal injury or damage to the instrument could occur if not observed. A symbol on the instrument is referenced in the manual with a precautionary statement.



Electrical equipment marked with this symbol may not be disposed of in European domestic or public disposal systems. Return old or end-of-life equipment to the manufacturer for disposal at no charge to the user.

3.4 Product components

Make sure that all components have been received. Refer to [Figure 2](#). If any items are missing or damaged, contact the manufacturer or a sales representative immediately.

Figure 2 Product components

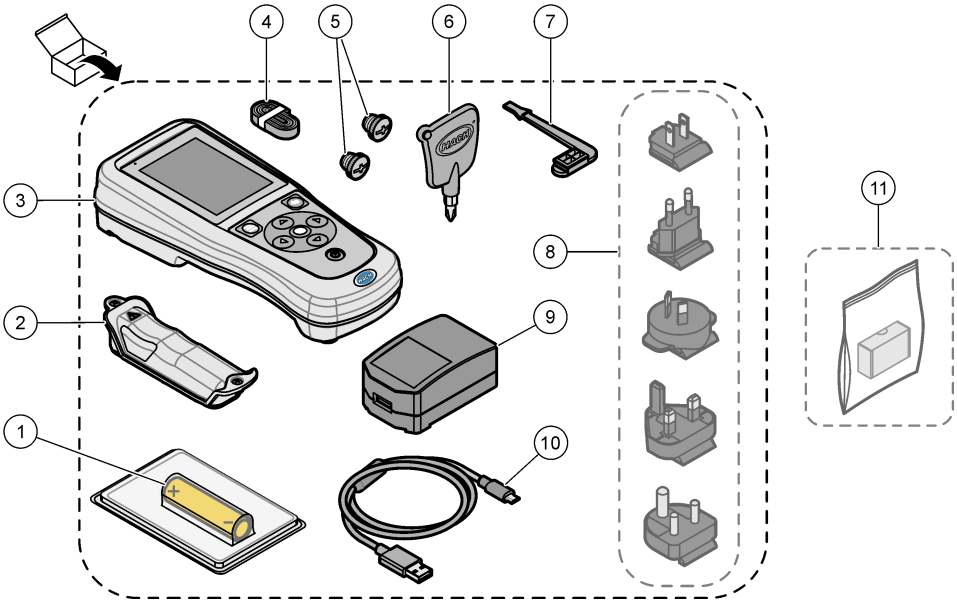

1 Rechargeable lithium-ion battery	7 USB port plug
2 Battery compartment	8 Optional power plugs
3 Meter	9 USB power adapter
4 Hand lanyard	10 USB cable, Type A to micro, 1 m (3.3 ft)
5 Probe connector plugs	11 Optional Hach Communication Dongle (HCD)
6 Screwdriver (#1 Phillips)	

3.5 Certification

Canadian Radio Interference-Causing Equipment Regulation, ICES-003, Class B:

Supporting test records reside with the manufacturer.

This Class B digital apparatus meets all requirements of the Canadian Interference-Causing Equipment Regulations.

Cet appareil numérique de classe B répond à toutes les exigences de la réglementation canadienne sur les équipements provoquant des interférences.

FCC Part 15, Class "B" Limits

Supporting test records reside with the manufacturer. The device complies with Part 15 of the FCC Rules. Operation is subject to the following conditions:

1. The equipment may not cause harmful interference.
2. The equipment must accept any interference received, including interference that may cause undesired operation.

Changes or modifications to this equipment not expressly approved by the party responsible for compliance could void the user's authority to operate the equipment. This equipment has been tested and found to comply with the limits for a Class B digital device, pursuant to Part 15 of the FCC rules. These limits are designed to provide reasonable protection against harmful interference when the equipment is operated in a commercial environment. This equipment generates, uses and can radiate radio frequency energy and, if not installed and used in accordance with the instruction manual, may cause harmful interference to radio communications. Operation of this equipment in a residential area is likely to cause harmful interference, in which case the user will be required to correct the interference at their expense. The following techniques can be used to reduce interference problems:

1. Move the equipment away from the device receiving the interference.
2. Reposition the receiving antenna for the device receiving the interference.
3. Try combinations of the above.

3.6 Hach Communication Dongle (optional)

The optional Hach Communication Dongle (HCD) uses Bluetooth^{®5} Low Energy to communicate with Claros. Follow all manufacturer guidance and warnings to install and operate the device. Refer to the documentation that is supplied with the HCD.

3.7 Intended use

▲ CAUTION	
	Chemical exposure hazard. Obey laboratory safety procedures and wear all of the personal protective equipment appropriate to the chemicals that are handled. Refer to the current safety data sheets (MSDS/SDS) for safety protocols.

The HQ Series portable meters are intended for use by individuals who measure water quality parameters in the laboratory or in the field. The HQ Series meters do not treat or alter water.

Section 4 Installation

▲ DANGER	
	Multiple hazards. Only qualified personnel must conduct the tasks described in this section of the document.

4.1 Lithium battery safety

▲ WARNING	
	Fire and explosion hazard. Lithium batteries may get hot, explode or ignite and cause serious injury if exposed to abuse conditions.

- Do not use the battery if there is visible damage.
- Do not use the battery after strong shock or vibration occurs.
- Do not expose the battery to fire or ignition.
- Keep the battery at temperatures less than 70 °C (158 °F).

⁵ The Bluetooth[®] word mark and logos are registered trademarks owned by the Bluetooth SIG, Inc. and any use of such marks by HACH is under license.

- Keep the battery dry and away from water.
- Prevent contact between the positive and negative battery terminals.
- Do not let unauthorized persons touch the battery.
- Discard the battery in accordance with local, regional and national regulations.
- Do not use or store the instrument in direct sunlight, near a heat source or in high temperature environments such as a closed vehicle in direct sunlight.

4.2 Install the battery

⚠ WARNING	
	<p>Fire and explosion hazard. This equipment contains a high energy lithium battery which can ignite and cause fire or explosion, even without power. To maintain the safety provided by the instrument enclosure, the instrument enclosure covers must be installed and secured with the supplied hardware.</p>

⚠ WARNING	
	<p>Explosion and fire hazard. Battery substitution is not permitted. Use only batteries that are supplied by the instrument manufacturer.</p>

Only use the manufacturer-supplied lithium-ion rechargeable battery. Refer to [Figure 3](#) for battery installation or removal.

Figure 3 Battery installation and removal

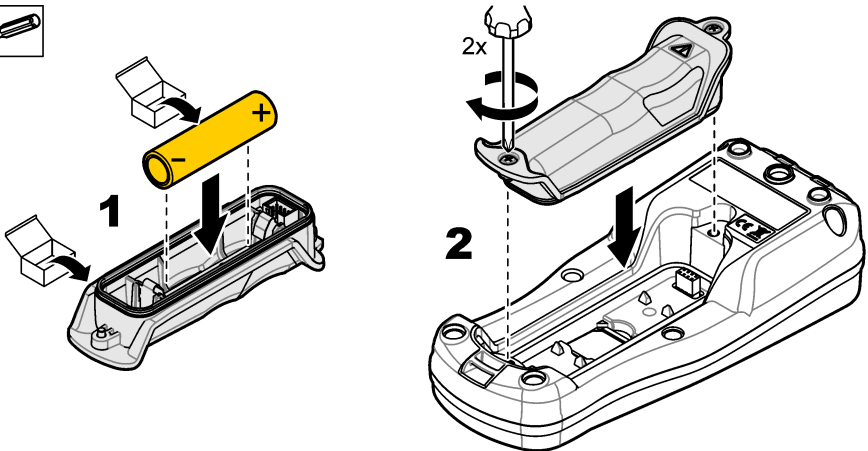

4.3 Charge the battery

⚠ DANGER	
	<p>Electrocution hazard. If this equipment is used outdoors or in potentially wet locations, a Ground Fault Circuit Interrupt (GFCI/GFI) device must be used for connecting the equipment to its main power source.</p>

▲ WARNING



Fire hazard. Use only the external power supply that is specified for this instrument.

▲ WARNING



Electrical shock hazard. Externally connected equipment must have an applicable country safety standard assessment.

Use the supplied USB cable and USB power adapter or a PC to charge the battery. Refer to [Figure 4](#). When the instrument connects to power and the on/off key is pushed, the green LED indicator is on. The user can operate the instrument while the battery charges. A battery with no charge becomes fully charged after approximately 5 hours when the USB power adapter is used and the instrument power is off.

Figure 4 Connect to the USB power adapter or a PC

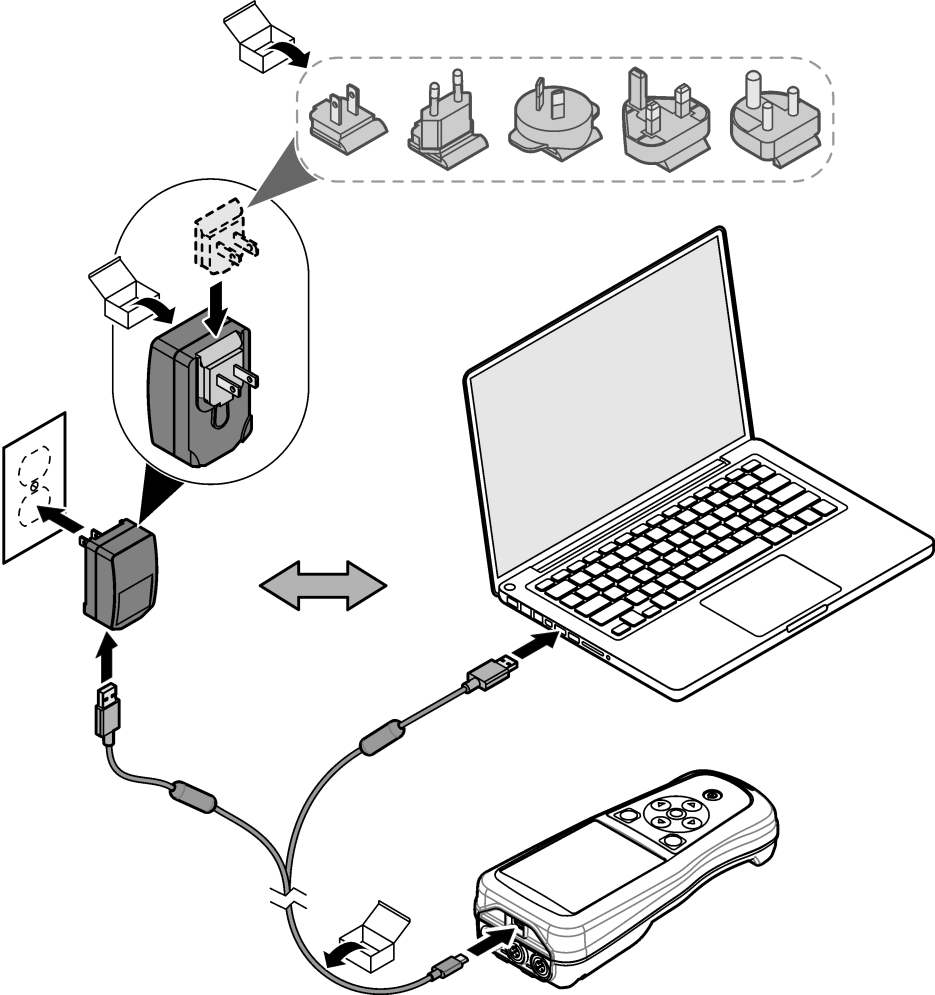

4.4 Install the lanyard

Install the lanyard to safely hold the meter. Refer to [Figure 5](#).

Figure 5 Lanyard installation

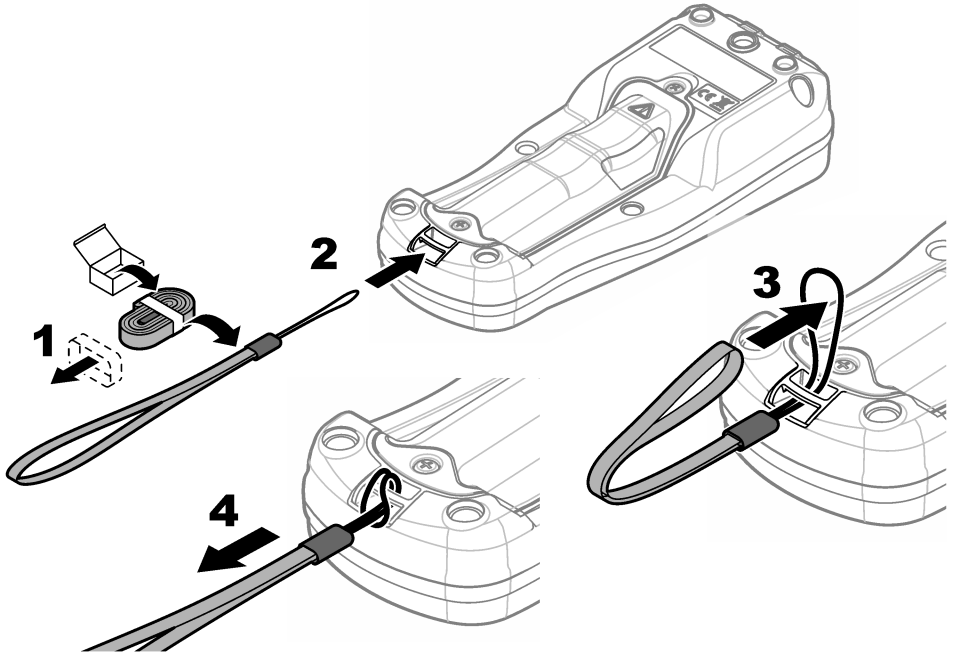

4.5 Install the probe and USB port plugs

Install the port plugs in the probe port(s) and USB port when the ports are not in use to keep the enclosure rating of the instrument. Refer to [Figure 6](#) and [Figure 7](#).

Note: [Figure 6](#) shows a meter with three probe ports. Some meter models have only one or two probe ports.

Figure 6 Port plug installation

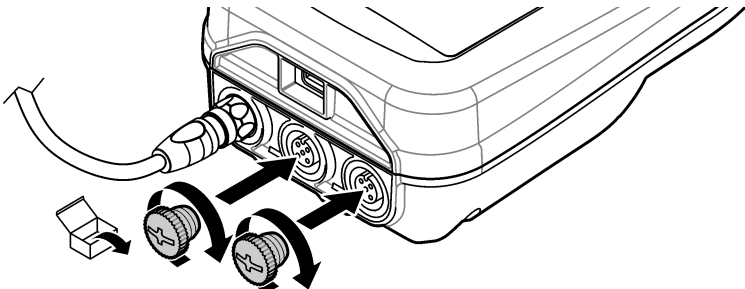
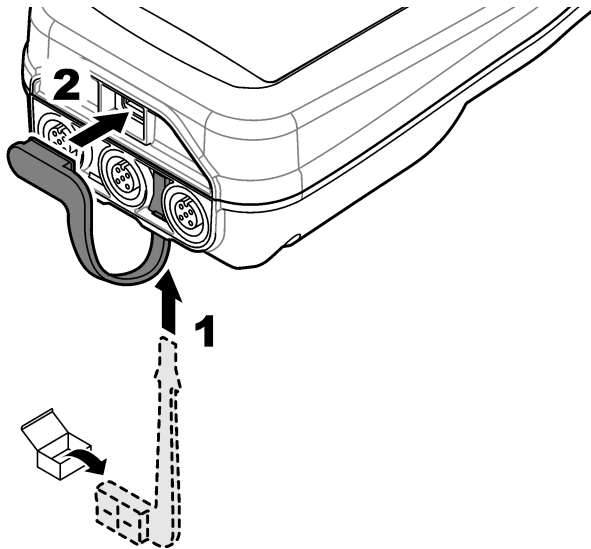



Figure 7 USB port plug installation



Section 5 Startup

5.1 Start the meter

Push  to start the meter. If the meter does not start, make sure that the battery is installed correctly or the meter is connected to a power source. Refer to [Charge the battery](#) on page 8.

5.2 Select the language

When the meter is powered on for the first time or when a new battery is installed, the display shows the language selection screen. Select the applicable language. The user can also change the language from the Settings menu.

5.3 Set the date and time

When the meter is powered on for the first time or when a new battery is installed, the display shows the Date-Time screen. Complete the steps that follow to set the date and time.

Note: *The user can also change the date and time from the Settings menu.*

1. Push the up and down arrow keys to select a date format.
2. Push the right arrow to go to the date and time.
3. Push the up and down arrow keys to change the date and time.
4. Push the right arrow to highlight Save.
5. Select Save to keep the settings.

5.4 Connect a probe

Make sure to set the time and date in the meter before a probe is connected. The time stamp for a probe is set when the probe is first connected to the meter. The time stamp automatically records the probe history and the time when measurements are made. Refer to [Figure 8](#) to connect a probe to the meter.

Figure 8 Connect a probe to the meter

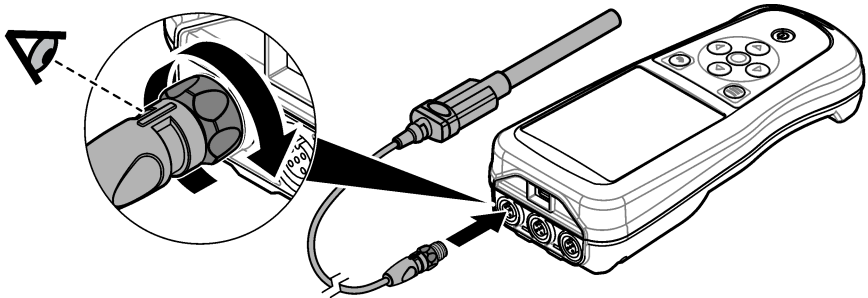

Section 6 User interface and navigation

After startup, the display shows the home screen. Refer to [Home screen](#) on page 13. Use the keypad to select the available options and to change values. Refer to [Keypad](#) on page 15. Use the main menu to go to settings and other menus. Refer to [Main menu](#) on page 16.

6.1 Home screen

The display shows the home screen when the meter is on and a probe is connected to the meter. Refer to [Figure 9](#). The HQ4100, HQ4200, HQ4300 models have a color display. For models with two or three probe ports, the screen shows all of the connected probes. Refer to [Figure 10](#).

The tasks that follow are available from the home screen:

- Measure samples
- Calibrate a probe
- Verify a calibration
- Set sample ID's (identification)
- View and manage data
- Read step-by-step instructions

Figure 9 Home screen example—One probe

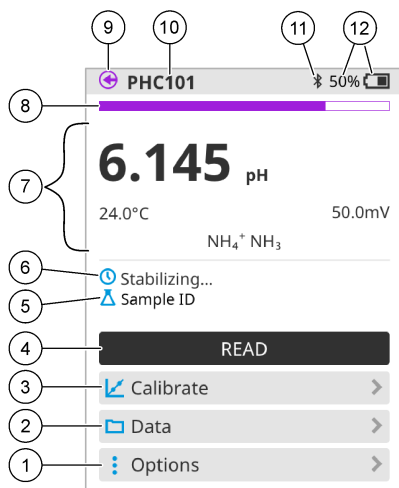

1 Options menu: gives access to instructions and other menus	7 Measurement value section: shows the measured value, temperature and units
2 Data menu: gives access to view and manage data	8 Measurement stability status indicator: shows the status of the measurement
3 Calibrate button: starts a calibration	9 Intellical probe port: shows the port location of the connected probe
4 Read button: reads the sample or standard solution value	10 Intellical probe name: shows the model name of the connected probe
5 Sample ID: shows the name of the sample that is measured	11 Bluetooth® icon (if Hach Communication Dongle is installed): shows when a bluetooth connection is active
6 Message area: shows the measurement status, sample ID, errors and warnings	12 Battery charge indicator: shows the percent of the battery charge

Figure 10 Home screen example—Two or three probes

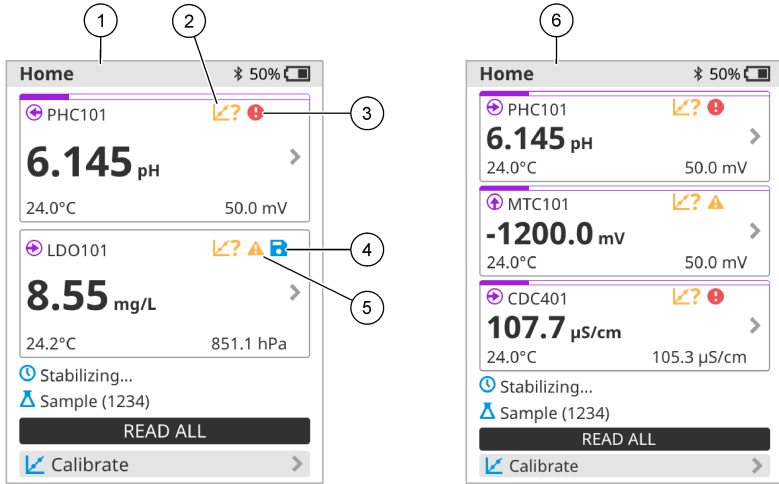

<p>1 Home screen with two probes</p>	<p>4 Save icon: the measurement data is in the data log</p>
<p>2 Calibrations icon: indicates that the calibration was not accepted or has expired</p>	<p>5 Warning icon (refer to Troubleshooting on page 32)</p>
<p>3 Error icon (refer to Troubleshooting on page 32)</p>	<p>6 Home screen with three probes</p>

6.2 Keypad

Refer to [Figure 11](#) for a description of the keypad.

Figure 11 Keypad description

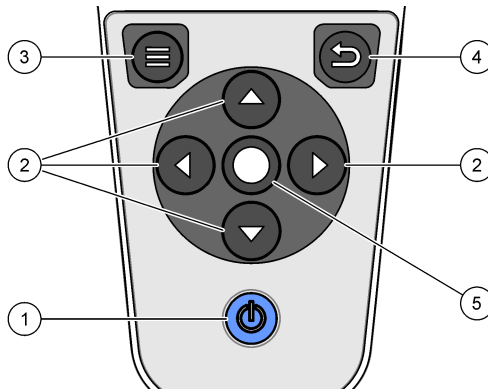

<p>1 On/off key</p>	<p>4 Back key</p>
<p>2 Navigation arrows</p>	<p>5 Select key</p>
<p>3 Menu key</p>	

6.3 Main menu

Push  to go to the main menu. Refer to [Figure 12](#).

Figure 12 Main menu description



1 Home screen	4 Sample ID menu	7 User ID
2 Settings menu	5 About meter screen	8 Bluetooth® icon (if HCD is installed)
3 Data menu	6 Date and time	9 Bluetooth® device ID (if HCD is installed)

Section 7 Operation

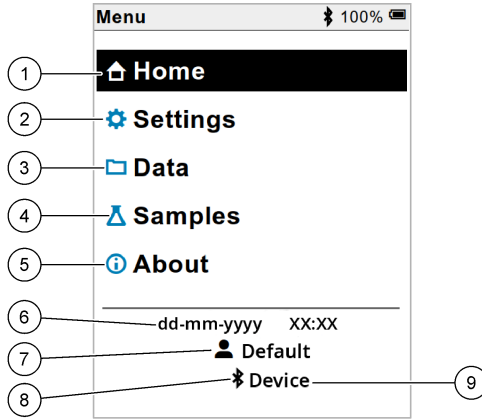
This section gives general operation instructions for the meter. For more complete instructions, refer to the on-screen instructions in the meter or in the user manual for the probe.

7.1 Measure samples

The steps that follow are general steps to measure samples with the meter.

1. Select the measurement mode. Refer to [Meter settings](#) on page 18.
2. Prepare the sample for measurement. Refer to the on-screen instructions in the meter or in the user manual for the probe.
3. Measure the sample as follows:
 - **Push to read mode:** Select Read (or Read all) to measure the sample value. The meter automatically saves the value.
 - **Interval mode:** Select Start (or Start all) to start the measurements. The meter automatically measures and saves the sample value at the specified time intervals. Select Stop (or Stop all) to stop the measurements.
 - **Continuous mode:** The meter measures the sample value continuously. Select Save (or Save all) to save the value that shows on the display screen.

After each measurement, the display shows the result. The save icon shows on the display if the result is saved in the data log.

7.2 Calibrate a probe

The steps that follow are general steps for probe calibration with the meter. To change the calibration settings, refer to [Probe settings](#) on page 19.

1. From the home screen, select  Calibrate. If more than one probe is connected, select the probe to calibrate. The display shows the solution(s) to use for the calibration.
2. Prepare the buffers or standard solutions for calibration. Use the on-screen instructions in the meter or in the user manual for the probe.
3. Select Read to start the calibration. The meter measures the value of the calibration solution. When the measurement is complete, the display shows the result.
4. Select Read to measure the value of the other buffers or standard solutions, if applicable. Select Save to save the calibration.

Note: If the calibration is not accepted, refer to the on-screen troubleshooting instructions in the meter or in the user manual for the probe.

7.3 Verify the calibration

The steps that follow are general steps to verify a probe calibration with the meter. To change the verification settings, refer to [Probe settings](#) on page 19.

1. From the home screen, select Options > Verify calibration. The display shows the buffer or standard solution to use for the verification.
Note: If more than one probe is connected, select the probe to verify.
2. Prepare the buffer or standard solution for verification. Use the on-screen instructions in the meter or in the user manual for the probe.
3. Select Read to start the verification. The meter measures the value of the verification solution. When the measurement is complete, the display shows the result.
4. If the verification is successful , select Save to save the result.

Note: If the verification is not accepted, refer to the on-screen troubleshooting instructions in the meter or in the user manual for the probe.

7.4 Include sample ID with measurement data

The instrument can save a sample name (ID) with the stored measurement data. Enter multiple sample names in the instrument, then select the applicable sample name before the samples are measured. The instrument adds numbers to samples with the same name, e.g., "Sample name (2)".

1. Push  and select Samples.
2. Select an option.

Option	Description
Sample	Selects the sample name to save with the sample measurements.
Create new sample	Opens a screen to add new sample names. Sample names can include letters and numbers.
Delete samples	Removes sample names.

7.5 Include user ID with stored data

The instrument can record a user name (ID) with the stored data. Enter multiple user names in the instrument, then select the applicable user name before calibrations or measurements are started.

1. Push  and select Settings. The list of settings shows.
2. Select Users.
3. Select an option.

Option	Description
User	Selects the user name. The selected user name shows on the main menu screen and is saved with the stored data.
Create new user	Opens a screen to add new user names. User names can include letters and numbers.
Delete users	Removes user names.

Section 8 Meter settings

Complete the steps that follow to change the general settings for the meter.

Note: Password protection may prevent access to some menus.

1. Push  and select Settings. The list of settings shows.
2. Select an option.

Option	Description
[Probe name]	Changes the probe-specific settings for measurements, calibration and verification. Refer to Probe settings on page 19 to change the settings for the connected probe.
Measurement mode	Sets when measurements are started. Options: Push to read, Continuous or Interval. Push to read: The sample is measured only when Read is pushed. Data is saved in the data log automatically when the stability criteria are met. Interval: The sample is measured at regular intervals for a specified duration. Data is stored in the data log automatically. Continuous: The meter measures the sample value continuously. Data is only saved in the data log when the user selects Save.
Temperature	Sets the temperature units to °C or °F.
Display	Changes the settings for the display. Options: Brightness, Backlight and Shutdown. Brightness: Changes the intensity of the backlight. Options: 10 to 100% (default: 50%). Backlight: Sets the backlight to off when the meter is not used for a specified time. Options: 15 seconds, 30 seconds, 1 minute, 5 minutes or Never. Shutdown: Sets the meter to off when the meter is not used for a specified time. Options: 1 minute, 2 minutes, 5 minutes, 10 minutes, 30 minutes, 1 hour, 2 hours or Never.
Sound	Sets the meter to make a sound during key presses or notifications. Options: Key Press, Stability Alert, Reminder, Error/Warning Alert or (battery) Charge Complete.
Users	Selects a user, adds a new user or deletes a user.

Option	Description
Date-Time	Sets the date/time format, date and time in the meter.
Language	Sets the meter language.
Access	Sets a password to prevent access to the probe settings, some meter settings (measurement mode, temperature, language) and software updates. A user without the password cannot delete settings or data when the access control is on.
Diagnostics	Makes a diagnostic file for technical support or service if a technical problem occurs. The user must connect the meter to a PC to get the file.

Section 9 Probe settings

Connect a probe to the meter to change the settings for measurements, calibrations and verifications. Refer to the applicable section that follows to change the settings for the connected probe.

Note: Password protection may prevent access to some menus. Refer to [Control access to settings](#) on page 30 for information on security settings.

- pH probes: [Change the pH settings](#) on page 19
- ORP probes: [Change the ORP settings](#) on page 21
- Conductivity probes: [Change the conductivity settings](#) on page 22
- LDO and LBOD probes: [Change the LDO or LBOD settings](#) on page 25
- ISE probes (e.g., NH₃, NH₄⁺, Cl⁻, F⁻, NO₃⁻ and Na⁺): [Change the ISE settings](#) on page 27

9.1 Change the pH settings

Refer to the steps that follow to change the settings for measurements, calibrations and verifications with a pH probe. The user can save the settings with a user-specified name.

1. Push  and select Settings. The list of settings shows.
2. Select PHC[probe number].
3. Select Measurement to change the settings for sample measurements.

Option	Description
Resolution and speed	Sets the number of decimal points and the stabilization time. A slow speed gives more time for the measurement to become stable. Options: 0.1 pH - Fast (0.1 pH/minute), 0.01 pH - Fast (0.1 pH/minute) (default), 0.01 pH - Normal (0.05 pH/minute), 0.01 pH - Slow (0.01 pH/minute) or 0.001 pH - Slow (0.01 pH/minute).
Lower limit	Sets the minimum accepted value for the measurement. The options are set by the minimum range limit of the pH probe.
Upper limit	Sets the maximum accepted value for the measurement. The options are set by the maximum range limit of the pH probe.
Maximum stability	Sets the maximum time that the meter waits for a measurement to become stable. Options: 30 to 600 seconds (default: 90 seconds).

4. Select Calibration to change the settings for calibrations.

Option	Description
Slope limit	Sets the accepted range of values (from theoretical) for the calibration slope. Options: 1 to 15% (default: 15%).
Buffer set	Selects the set of temperature-compensated pH buffers to use for calibration. All of the values in the buffer set show during calibration. The user can read all or some of the buffers. The minimum number is set in the Minimum calibration points setting. Options: Color Coded 4.01, 7.00, 10.01 (default) IUPAC 1.68, 4.01, 7.00, 10.01, 12.45 DIN 1.09, 4.65, 9.23 IUPAC 1.68, 4.01, 6.86, 10.01, 12.45 IUPAC 1.68, 4.01, 6.86, 9.18, 12.45 IUPAC 1.68, 4.01, 7.00, 9.18, 12.45 Custom: Select the buffer set from a list of standard and custom buffers. Options: Buffers, Add a buffer or Delete buffers.
Buffers	When Buffer set is set to Custom, selects the buffer set from a list of standard temperature-compensated pH buffer values and user-specified buffer values. Each buffer in the set must be a minimum 2 pH units apart from the other buffers. The maximum number of buffers in a set is 5.
Add a buffer	When Buffer set is set to Custom, lets the user enter a new value (within the range of the probe). Custom buffer values are not temperature compensated and should be read at 25 °C.
Delete buffers	When Buffer set is set to Custom, removes a custom buffer from the list of available buffers.
Minimum calibration points	Sets the minimum number of buffers that must be used for calibration. Options: 1 (default), 2 or 3.
Reminder	Sets a time interval for probe calibration. A reminder shows on the meter after the time interval. Options: Off (default), 2 hours, 4 hours, 8 hours, 2 days, 5 days or 7 days. The meter can also make a sound during the reminder (Settings > Sound).
Expiration	When Reminder is set to a time interval, changes the calibration status to expired after the reminder occurs. Options: Immediately after reminder, 30 minutes after reminder (default), 1 hour after reminder, 2 hours after reminder or Continue reading (calibration status does not change).

5. Select Verification to change the settings for calibration verifications.

Option	Description
Standard	Selects the pH buffer solution to use for verifications. Options (at 25 °C): 1.09 pH, 1.68 pH, 4.01 pH, 4.65 pH, 6.86 pH, 7.00 pH (default), 9.18 pH, 9.23 pH, 10.01 pH or 12.45 pH.
Acceptance range	Sets the range of pH values that will be accepted for verifications. Options: ±0.005 to 1.000 pH (default: ±0.100 pH).
Invalidate calibration	Changes the calibration status to expired if the verification result is not within the Acceptance range setting. Options: Yes or No (default).

Option	Description
Reminder	Sets a time interval for verification. A reminder shows on the meter after the time interval. Options: Off (default), 30 minutes, 2 hours, 4 hours, 8 hours, 12 hours or 24 hours.
Snooze reminders	When Reminder is set to a time interval, lets the user ignore a verification reminder for a selected time. Options: Yes (default) or No.
Snooze time	When Snooze reminders is set to Yes, sets the time when the verification reminder will show again. Options: 5 minutes, 10 minutes, 15 minutes (default), 30 minutes or 60 minutes.

6. Select Probe settings to manage the probe settings as a group.

Option	Description
Current	Selects the probe settings to use for measurements, calibrations and verifications. Options: Default, Edited or User-specified name. The Edited option shows when the current settings have changes but are not saved with a user-specified name.
Create new settings	Saves the current probe settings with a user-specified name (maximum 16 characters, letters and numbers).
Delete settings	Removes a user-specified probe setting that is not in use.

9.2 Change the ORP settings

Refer to the steps that follow to change the settings for measurements, calibrations and verifications with an ORP probe. The user can save the settings with a user-specified name.

1. Push  and select Settings. The list of settings shows.
2. Select MTC[probe number].
3. Select Measurement to change the settings for sample measurements.

Option	Description
Response time	Sets the stabilization time. A slow speed gives more time for the measurement to become stable. Options: Fast (2 mV/minute), Normal (1 mV/minute, default) or Slow (0.5 mV/minute).
Lower limit	Sets the minimum accepted value for the measurement. Options: -1200.0 to 1199.9 mV (default: -1200 mV).
Upper limit	Sets the maximum accepted value for the measurement. Options: -1199.9 to 1200.0 mV (default: 1200 mV).
Maximum stability	Sets the maximum time that the meter waits for a measurement to become stable. Options: 30 to 600 seconds (default: 300 seconds).

4. Select Calibration to change the settings for calibrations.

Option	Description
Standard	Sets the standard solution to use for calibration. Options: Zobell's (221 mV - 25 °C) (default), Light's (468 mV - 25 °C) or Custom (user-specified mV value). Measurements are temperature compensated when Zobell's solution is used for calibration.
Standard value	When Standard is set to Custom, sets the mV value for custom standard solutions. Options: -1200 mV to 1200 mV (default: 221 mV).

Option	Description
Offset limit	Sets the maximum mV value that is accepted for the offset. Options: 1 to 250 mV (default: 25 mV). The offset value is the difference between the expected and the measured mV value for the standard solution.
Reminder	Sets a time interval for probe calibration. A reminder shows on the meter after the time interval. Options: Off (default), 1 day, 7 days or 30 days. The meter can also make a sound during the reminder (Settings > Sound).
Expiration	When Reminder is set to a time interval, changes the calibration status to expired after the reminder occurs. Options: Immediately after reminder, 30 minutes after reminder (default), 1 hour after reminder, 2 hours after reminder or Continue reading (calibration status does not change).

5. Select Verification to change the settings for calibration verifications.

Option	Description
Standard	Sets the standard solution to use for verifications. Options: Zobell's (221 mV - 25 °C) (default), Light's (468 mV - 25 °C) or Custom (user-specified mV value).
Standard value	When Standard is set to Custom, sets the mV value for custom standard solutions. Options: -1200 mV to 1200 mV (default: 221 mV).
Acceptance range	Sets the range of mV values that will be accepted for verifications. Options: (±)1.0 to 25.0 mV (default: (±)10 mV).
Invalidate calibration	Changes the calibration status to expired if the verification result is not within the Acceptance range setting. Options: Yes or No (default).
Reminder	Sets a time interval for verification. A reminder shows on the meter after the time interval. Options: Off (default), 1 day, 7 days or 30 days.
Snooze reminders	When Reminder is set to a time interval, lets the user ignore a verification reminder for a selected time. Options: Yes (default) or No.
Snooze time	When Snooze reminders is set to Yes, sets the time when the verification reminder will show again. Options: 5 minutes, 10 minutes, 15 minutes (default), 30 minutes or 60 minutes.

6. Select Probe settings to manage the probe settings as a group.

Option	Description
Current	Selects the probe settings to use for measurements, calibrations and verifications. Options: Default, Edited or User-specified name. The Edited option shows when the current settings have changes but are not saved with a user-specified name.
Create new settings	Saves the current probe settings with a user-specified name (maximum 16 characters, letters and numbers).
Delete settings	Removes a user-specified probe setting that is not in use.

9.3 Change the conductivity settings

Refer to the steps that follow to change the settings for measurements, calibrations and verifications with a conductivity probe. The user can save the settings with a user-specified name.

1. Push  and select Settings. The list of settings shows.
2. Select CDC[probe number].

3. Select Measurement to change the settings for sample measurements.

Option	Description
Parameter	Sets the parameter for measurements. Options: Conductivity (default), Salinity, TDS or Resistivity. Conductivity is typically used for natural water samples. TDS is typically used to estimate the amount of total dissolved solids in the sample. Salinity is typically used for samples with a high salt content, such as sea water. Resistivity is typically used for ultra pure water applications.
Maximum stability	Sets the maximum time that the meter waits for a measurement to become stable. Options: 30 to 600 seconds (default: 60 seconds).
Units	Sets the measurement units for the selected parameter (applicable to Conductivity and Salinity). Options for Conductivity: Auto (default), $\mu\text{S}/\text{cm}$ or mS/cm . When Auto is selected, the units automatically change to mS/cm when the sample conductivity is high and $\mu\text{S}/\text{cm}$ when the conductivity is low. Select $\mu\text{S}/\text{cm}$ or mS/cm to always show the same units. Options for Salinity: ‰ (default), ppt, g/kg or Unitless.
Lower limit	Sets the minimum accepted value for the measurement. Options for Conductivity: 0.01 to 9998.90 $\mu\text{S}/\text{cm}$ or 0.0 to 1999.9 mS/cm . Options for Salinity: 0.0 to 41.9 ppt. Options for TDS: 0 to 49999 mg/L. Options for Resistivity: 0.5 to 49999900.0 $\Omega \cdot \text{cm}$.
Upper limit	Sets the maximum accepted value for the measurement. Options for Conductivity: 0.02 to 9999.00 $\mu\text{S}/\text{cm}$ or 0.1 to 2000.0 mS/cm . Options for Salinity: 0.1 to 42.0 ppt. Options for TDS: 1 to 50000 mg/L. Options for Resistivity: 0.6 to 50000000.0 $\Omega \cdot \text{cm}$.
Temperature correction	The meter adjusts the measured value to the value at the user-selected reference temperature (applicable to Conductivity and TDS). Options: None, Linear, NaCl/Non-Linear (default) or Natural Water.
Temperature Correction Factor	When the Temperature correction is set to Linear, sets a correction factor for the sample type. Options: 0%/°C to 9.99%/°C (default: 1.90%/°C). The correction factor may need to be determined experimentally. For example, the factor for ultrapure water is 4.55%/°C and the factor for NaCl salt solution 2.125%/°C.
Reference Temperature	Sets the reference temperature for the Temperature correction (applicable to Conductivity and TDS). Options: 20 °C or 25 °C (default).
TDS Form	When Parameter is set to TDS, sets the multiplier for conversion from conductivity to TDS. Options: NaCl (default, factor 0.5) or Custom (user-specified).
TDS Factor	When TDS Form is set to Custom, lets the user enter a TDS Factor.

4. Select Calibration to change the settings for calibrations.

Option	Description
Calibration standard	<p>Sets the standard solution to use for calibration. Options: KCl standard solutions: 1 D KCl, 111.3 mS/cm; 0.1 D KCl, 12.85 mS/cm; 0.01 D KCl, 1408 µS/cm; 0.1 M KCl, 12.88 mS/cm; 0.01 M KCl, 1413 µS/cm or 0.001 M KCl, 146.93 µS/cm NaCl standard solutions: 18 mS/cm; 1000 µS/cm (default); 180 µS/cm; 25 µS/cm or 0.05% 1015 µS/cm Sea water Custom: The user selects the Standard Units, Standard value, Reference Temperature and Temperature Correction Factor.</p>
Standard Units	When the Calibration standard is set to Custom, sets the units for a custom standard solution. Options: µS/cm (default) or mS/cm.
Standard value	When Standard is set to Custom, sets the conductivity value of a custom standard solution.
Reference Temperature	When Standard is set to Custom, sets the reference temperature for a custom standard solution. Options: 20 °C or 25 °C (default).
Temperature Correction Factor	When Standard is set to Custom, sets the temperature correction factor for a custom standard solution. Options: 0%/°C to 9.99%/°C (default: 1.90%/°C).
Reminder	Sets a time interval for probe calibration. A reminder shows on the meter after the time interval. Options: Off (default), 2 hours, 4 hours, 8 hours, 2 days, 5 days or 7 days. The meter can also make a sound during the reminder (Settings > Sound).
Expiration	When Reminder is set to a time interval, changes the calibration status to expired after the reminder occurs. Options: Immediately after reminder, 30 minutes after reminder (default), 1 hour after reminder, 2 hours after reminder or Continue reading (calibration status does not change).

5. Select Verification to change the settings for calibration verifications.

Option	Description
Standard	<p>Sets the standard solution to use for verifications. Options: KCl standard solutions: 1 D KCl, 111.3 mS/cm; 0.1 D KCl, 12.85 mS/cm; 0.01 D KCl, 1408 µS/cm; 0.1 M KCl, 12.88 mS/cm; 0.01 M KCl, 1413 µS/cm; 0.001 M KCl, 146.93 µS/cm NaCl standard solutions: 18 mS/cm; 1000 µS/cm (default); 180 µS/cm; 25 µS/cm; 0.05% 1015 µS/cm Sea water Custom: the user selects the Standard Units, Standard value, Reference Temperature and Temperature Correction Factor.</p>
Standard Units	When Standard is set to Custom, sets the units for a custom standard solution. Options: µS/cm (default) or mS/cm.
Standard value	When Standard is set to Custom, sets the conductivity value of a custom standard solution.
Reference Temperature	When Standard is set to Custom, sets the reference temperature for a custom standard solution. Options: 20 °C or 25 °C (default).

Option	Description
Temperature Correction Factor	When Standard is set to Custom, sets the temperature correction factor for a custom standard solution. Options: 0%/°C to 9.99%/°C (default: 1.90%/°C).
Acceptance range	Sets the range of values that will be accepted for verifications. Options: 1 to 9% from the expected value (default: 8%).
Invalidate calibration	Changes the calibration status to expired if the verification result is not within the Acceptance range setting. Options: Yes or No (default).
Reminder	Sets a time interval for verification. A reminder shows on the meter after the time interval. Options: Off (default), 30 minutes, 2 hours, 4 hours, 8 hours, 12 hours or 24 hours.
Snooze reminders	When Reminder is set to a time interval, lets the user ignore a verification reminder for a selected time. Options: Yes (default) or No.
Snooze time	When Snooze reminders is set to Yes, sets the time when the verification reminder will show again. Options: 5 minutes, 10 minutes, 15 minutes (default), 30 minutes or 60 minutes.

6. Select Probe settings to manage the probe settings as a group.

Option	Description
Current	Selects the probe settings to use for measurements, calibrations and verifications. Options: Default, Edited or User-specified name. The Edited option shows when the current settings have changes but are not saved with a user-specified name.
Create new settings	Saves the current probe settings with a user-specified name (maximum 16 characters, letters and numbers).
Delete settings	Removes a user-specified probe setting that is not in use.

9.4 Change the LDO or LBOD settings

Refer to the steps that follow to change the settings for measurements, calibrations and verifications with an LDO or LBOD probe. The user can save the settings with a user-specified name.

1. Push  and select Settings. The list of settings shows.
2. Select LDO[probe number] or LBOD[probe number].
3. Select Measurement to change the settings for sample measurements.

Option	Description
DO units	Sets the measurement units. Options: mg/L (default) or %.
Resolution and speed	Sets the number of decimal points and stabilization time. A slow speed gives more time for the measurement to become stable. Options: 0.1 - Fast - (0.35mg/L)/min, 0.01 - Fast - (0.35mg/L)/min, 0.01 - Normal - (0.15mg/L)/min (default) or 0.01 - Slow - (0.05mg/L)/min.
Lower limit	Sets the minimum accepted value for the measurement. Options: 0.00 to 19.90 mg/L or 0 to 199% (default: 0.00 mg/L).
Upper limit	Sets the maximum accepted value for the measurement. Options: 0.10 to 20.00 mg/L or 1 to 200% (default: 20.00 mg/L).

Option	Description
Pressure units	<p>Sets the units for the air pressure. Options: hPa (default), mBar, inHg or mmHg.</p> <p>The meter shows the atmospheric pressure at the current elevation. This pressure reading will not agree with readings from sources that report atmospheric pressure at sea level.</p>
Salinity correction mode	<p>Sets the meter to correct for the salinity value of samples. Options: Off (default), Manual or Auto.</p> <p>Salinity lowers the solubility of dissolved oxygen in water. To correct for salinity in the sample, set Salinity correction mode to Manual and enter the salinity value of the sample.</p> <p>For meters with more than one probe connector, set Salinity correction mode to Auto and connect a conductivity probe. The conductivity probe measures the sample salinity and automatically corrects the dissolved oxygen reading.</p>
Salinity correction	<p>When Salinity correction mode is set to Manual, sets the salinity value of the sample. Options: 0.1 to 70.0 ‰ (default: 35.0 ‰).</p>
Averaging interval	<p>Sets the meter to use the average value of measurements during a specified time interval. Options: Off (default), 30 seconds, 60 seconds, 90 seconds, 3 minutes or 5 minutes.</p> <p>The averaging interval is useful for samples that contain a lot of air bubbles, which cause the dissolved oxygen readings to constantly change. To make the readings more stable, increase the averaging interval. The meter will record measurements at the same frequency but show only the average of the measurements for the specified time interval.</p>

4. Select Calibration to change the settings for calibrations.

Option	Description
Calibration mode	<p>Sets the type of calibration. Options: 100% (100% water-saturated air, default), 100% with 0 (100% water-saturated air with 0 point), mg/L (calibration with a solution of known dissolved oxygen concentration), mg/L with 0 (calibration with a solution of known dissolved oxygen concentration with 0 point) or Factory (factory calibration option, applicable only to LDO probes).</p>
Standard value	<p>When Calibration mode is set to mg/L or mg/L with 0, sets the concentration of the solution to use for calibration. Options: 2.00 to 20.00 mg/L (default: 7.00 mg/L).</p>

Option	Description
Reminder	Sets a time interval for probe calibration. A reminder shows on the meter after the time interval. Options: Off (default), 8 hours, 12 hours, 1 day, 2 days, 5 days or 7 days. The meter can also make a sound during the reminder (Settings > Sound).
Expiration	When Reminder is set to a time interval, changes the calibration status to expired after the reminder occurs. Options: Immediately after reminder, 30 minutes after reminder (default), 1 hour after reminder, 2 hours after reminder or Continue reading (calibration status does not change).

5. Select Probe settings to manage the probe settings as a group.

Option	Description
Current	Selects the probe settings to use for measurements and calibrations. Options: Default, Edited or User-specified names. The Edited option shows when the current settings have changes but are not saved with a user-specified name.
Create new settings	Saves the current probe settings with a user-specified name (maximum 16 characters, letters and numbers).
Delete settings	Removes a user-specified probe setting that is not in use.

9.5 Change the ISE settings

Refer to the steps that follow to change the settings for measurements, calibrations and verifications with an ISE probe. The user can save the settings with a user-specified name.

1. Push  and select Settings. The list of settings shows.
2. Select ISE[probe name] (e.g., ISEF121).
3. Select Measurement to change the settings for sample measurements.

Option	Description
Form	Sets the chemical form (applicable to ammonia, ammonium and nitrate probes). Options for ammonia probe: NH_3 or $\text{NH}_3\text{—N}$. Options for ammonium probe: NH_4^+ , $\text{NH}_4^+\text{—N}$ or $\text{NH}_4^+\text{—NH}_3$ (ammonium as ammonia). Options for nitrate probe: NO_3 or $\text{NO}_3\text{—N}$.
Units	Sets the measurement units. Options: mg/L (default), $\mu\text{g/L}$, g/L, g/kg, mol/L, mmol/L, mol/kg, %, ppm or ppb.
Lower limit	Sets the minimum accepted value for the measurement. The options are set by the minimum range limit and the selected units of the ISE probe.
Upper limit	Sets the maximum accepted value for the measurement. The options are set by the maximum range limit and the selected units of the ISE probe.
Significant digits	Sets the number of significant digits to show for the measurements. Options: 2, 3 (default) or 4.
Auto-stabilization	Sets the meter to use the default stabilization rate of 1.0 mV/minute. Options: Yes (default) or No.

Option	Description
Stability criteria	When Auto-stabilization is set to No, sets the stabilization rate that determines when measurements are stable. Options: 0.1 mV/minute to 9.9 mV/minute (default: 1.0 mV/minute). A lower value gives more time for the measurements to become stable.
Maximum stability	Sets the maximum time that the meter waits for a measurement to become stable. Options: 30 to 1200 seconds (default: 600 seconds).

4. Select Calibration to change the settings for calibrations.

Option	Description
Standard set	Selects the standard solutions to use for calibration from a list of pre-set and user-specified standard solution values. The set must have a minimum of two and a maximum of five standards.
Form	Sets the chemical form (applicable to ammonia, ammonium and nitrate probes). Options for ammonia probe: NH_3 or $\text{NH}_3\text{—N}$. Options for ammonium probe: NH_4^+ , $\text{NH}_4^+\text{—N}$ or $\text{NH}_4^+\text{—NH}_3$ (ammonium as ammonia). Options for nitrate probe: NO_3 or $\text{NO}_3\text{—N}$.
Units	Sets the calibration units. Options: mg/L (default), $\mu\text{g/L}$, g/L, g/kg, mol/L, mmol/L, mol/kg, %, ppm or ppb.
Add a standard	Lets the user enter a user-specified standard solution value.
Delete standards	Removes a user-specified standard solution from the list of available standard solutions.
Slope limit	Sets the accepted range of values (from theoretical) for the calibration slope. Options: 1 to 30% (default: 15%).
Reminder	Sets a time interval for probe calibration. A reminder shows on the meter after the time interval. Options: Off (default), 2 hours, 4 hours, 8 hours, 2 days, 5 days or 7 days. The meter can also make a sound during the reminder (Settings > Sound).
Expiration	When Reminder is set to a time interval, changes the calibration status to expired after the reminder occurs. Options: Immediately after reminder, 30 minutes after reminder (default), 1 hour after reminder, 2 hours after reminder or Continue reading (calibration status does not change).

5. Select Verification to change the settings for calibration verifications.

Option	Description
Standard	Selects the standard solution to use for calibration verification from a list of pre-set and user-specified standard solution values.
Form	Sets the chemical form (applicable to ammonia, ammonium and nitrate probes). Options for ammonia probe: NH_3 or $\text{NH}_3\text{—N}$. Options for ammonium probe: NH_4^+ , $\text{NH}_4^+\text{—N}$ or $\text{NH}_4^+\text{—NH}_3$ (ammonium as ammonia). Options for nitrate probe: NO_3 or $\text{NO}_3\text{—N}$.
Units	Sets the verification units. Options: mg/L, $\mu\text{g/L}$, g/L, g/kg, mol/L, mmol/L, mol/kg, %, ppm, ppb.
Add a standard	Lets the user enter a user-specified standard solution value.

Option	Description
Delete standards	Removes a user-specified standard solution from the list of available standard solutions.
Reminder	Sets a time interval for verification. A reminder shows on the meter after the time interval. Options: Off (default), 30 minutes, 2 hours, 4 hours, 8 hours, 12 hours or 24 hours.
Acceptance range	Sets the accepted range of values for the measured verification solution. Options: 1% to 20% (default: 10%).
Invalidate calibration	Changes the calibration status to expired if the verification result is not within the Acceptance range setting. Options: Yes or No (default).
Snooze reminders	When Reminder is set to a time interval, lets the user ignore a verification reminder for a selected time. Options: Yes (default) or No.
Snooze time	When Snooze reminders is set to Yes, sets the time when the verification reminder will show again. Options: 5 minutes, 10 minutes, 15 minutes (default), 30 minutes or 60 minutes.

6. Select Probe settings to manage the probe settings as a group.

Option	Description
Current	Selects the probe settings to use for measurements, calibrations and verifications. Options: Default, Edited or User-specified name. The Edited option shows when the current settings have changes but are not saved with a user-specified name.
Create new settings	Saves the current probe settings with a user-specified name (maximum 16 characters, letters and numbers).
Delete settings	Removes a user-specified probe setting that is not in use.

Section 10 Data management

The meter saves the data from sample measurements, calibrations and verifications as follows:

- **Sample measurements**—The meter automatically saves the measured sample data when the measurement mode is Push to read or Interval. When the measurement mode is Continuous, the user must select Save to save the measured sample data. The save icon shows on the Home screen when the measured sample data is in the data log.
- **Calibration data**—The user must select Save to save the calibration data. The calibration data is saved in the meter and in the Intellical probe.
- **Verification data**—The user must select Save to save the verification data.

Complete the steps that follow to view, export or delete data.

1. Push  and select Data, or select Data from the Home screen.
2. Select an option.

Option	Description
View data	Shows the data in the data log. The most recent data shows first. Push the down arrow to see more data. The calibration icon shows when the data type is calibration data. The verification icon shows when the data type is verification data. To see more details for a data point, select a data row and push the right arrow. To apply a filter and show only the filtered data, push the left arrow and select a parameter, data type or date range.

Option	Description
Export data	<p>Sends a copy of all of the data in the data log to a connected PC or a USB storage device. To connect the instrument to a PC, refer to Figure 4 on page 10. To connect the instrument to a standard USB storage device, use a micro USB to USB Type A adapter. Alternatively, use a USB storage device that has a micro USB connector.</p> <p>When the instrument connects to a PC, a File Explorer window opens to a drive with the name "HQ-Series". Expand the drive and look for a subfolder with the meter name and serial number. The data file shows as a .csv file with the date and time as the file name. Save the .csv file to a location on the PC.</p> <p><i>Note: If the File Explorer window does not open automatically, open a File Explorer window and look for a drive with the name "HQ-Series".</i></p>
Calibration history	Shows the current and previous calibration data for a connected probe.
Delete data	Erases all of the data in the data log. Password protection may prevent access to the delete data option.

Section 11 Advanced operation

11.1 Control access to settings

Use the Access menu to prevent unwanted changes to the settings. Users must enter a personal identification number (PIN) to get access to the menu options that follow:

- Measurement mode settings
- Temperature settings
- Language settings
- Delete users
- Delete data
- Delete sample names
- Probe settings
- Delete probe settings
- Software updates

1. To add a PIN number, complete the steps that follow.
 - a. Push  and select Settings. The list of settings shows.
 - b. Select Access, then CONTINUE.
 - c. Use the arrow keys to enter a PIN.
 - d. Select Save. The display shows "Restrict access: On".
 - e. Select the LOCK button to lock the meter.
2. To edit a locked menu, complete the steps that follow.
 - a. Select the locked menu. The Enter PIN screen shows.
 - b. Use the arrow keys to enter the PIN and select Done.
 - c. Make the necessary changes.
 - d. When changes are complete, go to the Access menu.
 - e. Select the LOCK button to lock the meter again.

11.2 Update the meter software



Install software updates regularly for best results. The meter and probe settings do not change when a different software version is installed. Data is not erased during software updates, but the manufacturer recommends to first export the data as a precaution.

Pre-requisites:

- Make sure that the battery level is 50% or more. If less than 50%, charge the battery.
- Disconnect the probe(s) to make sure that sufficient power is available for the update process.
- Export the data from the data log. Refer to [Data management](#) on page 29.
- Use a PC with Windows 7 or Windows 10⁶.

1. Find the software upgrade file (.swu) on the manufacturer's website.
2. Download the software upgrade file to a PC.
3. Push  to start the meter.
4. Connect the USB cable to the meter and to the PC.
5. Open a File Explorer window.

Note: On some PC's, the File Explorer window will open automatically.

6. In the File Explorer window, look for a drive with the name "HQ-Series".
7. Expand the drive and open the folder with the meter name.
8. Copy the software file from the PC download location to the folder with the meter name.
9. When the copy operation is complete, disconnect the meter from the PC.
10. Connect the meter to a power source.
11. Push  and select About. The current software version shows.
12. Select Update software, then CONTINUE.
13. Select UPDATE. The update process starts. The meter reboots more than one time. When the update is complete, the Home screen shows.
14. Push  and select About to make sure that the new software version shows.

11.3 View the probe information

The probe information screen shows the probe model number, connected port location (if the meter has more than one probe connector), serial number, date of first use and the software version. The probe must be connected to the meter.

1. Push  and select Settings. The list of settings shows.
2. Select a probe.
3. Select About. The probe information screen shows.

11.4 View the meter information

The meter information screen shows the meter model number, serial number and software version.

1. Push .
2. Select About. The meter information screen shows.

Section 12 Maintenance

WARNING



Multiple hazards. Only qualified personnel must conduct the tasks described in this section of the document.

⁶ Microsoft® Windows® is a registered trademark of Microsoft Corporation in the United States and other countries.

12.1 Clean the instrument

Clean the exterior of the instrument with a moist cloth and a mild soap solution and then wipe the instrument dry as necessary.

12.2 Replace the battery

Replace the battery when the battery does not charge or does not hold a charge. Use only the battery and the battery charger that are supplied by the manufacturer. Refer to [Install the battery](#) on page 8.



12.3 Prepare for shipping

The instrument contains a lithium-ion battery, which is regulated as a hazardous material and must comply with hazardous goods regulations for all types of transport. Use the procedures that follow to send the instrument for repair or maintenance:

- Disconnect the probes before shipping.
- Clean and decontaminate the instrument before shipping.
- For the best safety, remove the lithium-ion battery from the device and do not send the battery. If the battery must be sent, keep the battery installed in the battery enclosure but do not attach the battery enclosure to the instrument. Put the battery enclosure with the installed battery in separate packaging to prevent contact with electrically conductive materials (e.g., metals).
- Ship the instrument in the original packaging or ship the instrument in an alternative protective packaging.

Section 13 Troubleshooting

13.1 Use the on-screen troubleshooting instructions

The user interface has troubleshooting instructions to help correct problems that can occur during measurements, calibrations and verifications. When a problem occurs, the display shows the error  or warning  icon with a short description of the problem. Push the right arrow to see the recommended procedures to correct the problem.

13.2 Export a diagnostic file

If technical support or service requests a diagnostic file, use the diagnostics option to export a file with diagnostic records and system logs. The diagnostic file is password-protected and can only be opened by technical support or service.

1. Push  and select Settings. The list of settings shows.
2. Select Diagnostics. The diagnostic data is automatically sent to the SD card in the meter.
3. Connect the USB cable to the meter and to the PC. A File Explorer window opens.
4. In the File Explorer window, look for a drive with the name "HQ-Series".
5. Expand the drive and open the folder with the meter name (e.g., HQ4300).
6. Open the diag-backup subfolder and find the exported zip file.
7. Use the instructions from the support technician to send the file for analysis.

13.3 Troubleshooting table

The possible errors in [Table 2](#) are specific to the meter. For help with problems with sample measurements, calibrations and verifications, refer to the user manual for the applicable probe.

Table 2 Troubleshooting table

Message	Description	Solution
Probe not supported	The connected probe can only operate with a different meter model.	Use a meter model that can be used with the connected probe. Refer to Table 1 on page 3.
Probe not recognized	The meter software does not recognize the connected probe. This message can occur when new meter software is available that the meter does not have.	Make sure that the probe can be used with the meter, then update the meter software.
Probe not communicating	The probe does not connect to the meter correctly.	Remove and connect the probe again. Connect a different probe to see if the problem is with the probe or the meter.
Battery cannot charge	The temperature is not within the range that is necessary for the battery to charge.	Increase or decrease the temperature and wait until the battery is within the temperature range of 0 °C to 40 °C (32 °F to 104 °F).
Low battery error	The battery charge is below the capacity limit that is necessary to complete a measurement.	Charge or replace the battery.
Low battery warning	The battery charge is low and near the capacity limit that is necessary to complete a measurement.	Charge or replace the battery.
Database is full	The number of data points in the data log is near capacity.	Export the data from the meter immediately to prevent data loss.

Section 14 Replacement parts

⚠ WARNING



Personal injury hazard. Use of non-approved parts may cause personal injury, damage to the instrument or equipment malfunction. The replacement parts in this section are approved by the manufacturer.

Note: Product and Article numbers may vary for some selling regions. Contact the appropriate distributor or refer to the company website for contact information.

Replacement parts

Description	Item no.
Battery, rechargeable 18650 lithium-ion, 3.7 VDC, 3400 mAh	LEZ015.99.00001
Cable, USB 2.0 plug type A to micro plug type B, 0.91 m (3 ft)	LEZ015.99.00002
Field case for standard probes	LEZ015.99.A001A
Field case for rugged probes	LEZ015.99.A002A

Replacement parts (continued)

Description	Item no.
Hand lanyard and dust plugs	LEZ015.99.A005A
Kickstand with hand strap	LEZ015.99.A003A
Protective glove	LEZ015.99.A004A
USB power adapter, 5 VDC, 2 A, 100–240 VAC, US	LEZ015.99.00006
USB power adapter, 5 VDC, 2 A, 100–240 VAC, EU + UK	LEZ015.99.00004
USB power adapter, 5 VDC, 2 A, 100–240 VAC, China	LEZ015.99.00005
USB power adapter, 5 VDC, 2 A, 100–240 VAC, ROW	LEZ015.99.00007



HACH COMPANY World Headquarters

P.O. Box 389, Loveland, CO 80539-0389 U.S.A.
Tel. (970) 669-3050
(800) 227-4224 (U.S.A. only)
Fax (970) 669-2932
orders@hach.com
www.hach.com

HACH LANGE GMBH

Willstätterstraße 11
D-40549 Düsseldorf, Germany
Tel. +49 (0) 2 11 52 88-320
Fax +49 (0) 2 11 52 88-210
info-de@hach.com
www.de.hach.com

HACH LANGE Sàrl

6, route de Compois
1222 Vézenaz
SWITZERLAND
Tel. +41 22 594 6400
Fax +41 22 594 6499