

Register your instrument!  
[www.eppendorf.com/myeppendorf](http://www.eppendorf.com/myeppendorf)



# Centrifuge 5702/5702 R/5702 RH

Original instructions

Copyright © 2020 Eppendorf AG, Germany. All rights reserved, including graphics and images. No part of this publication may be reproduced without the prior permission of the copyright owner.

Centriplus® is a registered trademark of Millipore Corporation, USA.

CombiSlide® is a registered trademark of Eppendorf AG, Germany.

Eppendorf® and the Eppendorf Brand Design are registered trademarks of Eppendorf AG, Germany.

Registered trademarks and protected trademarks are not marked in all cases with ® or ™ in this manual.

U.S. Patents are listed on [www.eppendorf.com/ip](http://www.eppendorf.com/ip).

## Table of contents

<b>1</b>	<b>Operating instructions</b>	<b>7</b>
1.1	Using this manual	7
1.2	Danger symbols and danger levels	7
1.2.1	Danger symbols	7
1.2.2	Danger levels	7
1.3	Symbols used	7
1.4	Abbreviations used	8
<b>2</b>	<b>Safety</b>	<b>9</b>
2.1	Intended use	9
2.2	User profile	9
2.3	Information on product liability	9
2.4	Application limits	10
2.4.1	Declaration concerning the ATEX directive (2014/34/EU)	10
2.5	Warnings for intended use	10
2.5.1	Personal injury or damage to device	10
2.5.2	Incorrect handling of the centrifuge	12
2.5.3	Incorrect handling of the rotors	14
2.5.4	Extreme strain on the centrifugation tubes	15
2.6	Safety instructions on the device	16
<b>3</b>	<b>Product description</b>	<b>17</b>
3.1	Product overview	17
3.1.1	Centrifuge 5702	17
3.1.2	Centrifuge 5702 R / RH	18
3.2	Delivery package	19
3.3	Features	19
3.4	Name plate	21
<b>4</b>	<b>Installation</b>	<b>23</b>
4.1	Selecting the location	23
4.2	Preparing installation	24
4.3	Installing the instrument	25
<b>5</b>	<b>Operation</b>	<b>27</b>
5.1	Operating controls	27
5.2	Switching on the centrifuge	30
5.3	Replacing the rotor	30
5.3.1	Inserting the rotor	30
5.3.2	Removing the rotor	30
5.4	Loading a fixed-angle rotor	31
5.5	Loading a swing-bucket rotor	31
5.5.1	Inserting the bucket in the swing-bucket rotor	32
5.5.2	Performing an imbalance calibration	32
5.5.3	Loading buckets symmetrically	32
5.6	Closing the centrifuge lid	34

**Table of contents**

Centrifuge 5702/5702 R/5702 RH  
English (EN)

5.7	Centrifugation . . . . .	35
5.7.1	Centrifugation with time setting . . . . .	35
5.7.2	Centrifuging in continuous operation . . . . .	36
5.7.3	Short run centrifugation . . . . .	36
5.7.4	Setting the soft ramp . . . . .	37
5.7.5	Setting the start of the time counting (At set rpm function) . . . . .	37
5.7.6	Calculating the speed of centrifugation . . . . .	38
5.8	Centrifuge 5702 R, Centrifuge 5702 RH: Heating and cooling. . . . .	38
5.8.1	Setting the temperature . . . . .	38
5.8.2	Temperature display . . . . .	39
5.8.3	Temperature monitoring . . . . .	39
5.8.4	Temperature control run FastTemp. . . . .	39
5.8.5	Continuous cooling . . . . .	40
5.8.6	Centrifuge 5702 RH: Temperature profiles . . . . .	41
5.9	Aerosol-tight centrifugation . . . . .	42
5.9.1	Aerosol-tight centrifugation in a fixed-angle rotor . . . . .	42
5.10	Switching off the centrifuge . . . . .	43
<b>6</b>	<b>Device settings . . . . .</b>	<b>45</b>
6.1	Changing the operating state . . . . .	45
6.2	Key lock. . . . .	45
6.2.1	Centrifuge 5702 R, Centrifuge 5702 RH: Securing the program against changes . . . . .	46
6.2.2	Centrifuge 5702: Displaying the key lock status. . . . .	46
6.3	Speakers . . . . .	46
6.3.1	Display the status of the speakers. . . . .	47
<b>7</b>	<b>Programs . . . . .</b>	<b>49</b>
7.1	Creating and storing a program . . . . .	49
7.2	Saving the current settings as a program . . . . .	49
7.3	Calling up a program . . . . .	50
7.4	Editing programs . . . . .	50
7.5	Deleting programs . . . . .	50
7.6	Exiting the program . . . . .	50
<b>8</b>	<b>Maintenance . . . . .</b>	<b>51</b>
8.1	Service. . . . .	51
8.2	Preparing cleaning/disinfection . . . . .	51
8.3	Cleaning/disinfection . . . . .	52
8.3.1	Cleaning and disinfecting the device . . . . .	53
8.3.2	Cleaning and disinfecting the rotor . . . . .	53
8.4	Additional care instructions for refrigerated centrifuges. . . . .	54
8.5	Cleaning glass breakage . . . . .	54
8.6	Replacing the fuses . . . . .	55
8.7	Decontamination before shipment . . . . .	55
<b>9</b>	<b>Troubleshooting . . . . .</b>	<b>57</b>
9.1	General errors . . . . .	57
9.2	Error messages . . . . .	58
9.3	Emergency release . . . . .	61

<b>10 Transport, storage and disposal</b> .....	<b>63</b>
10.1 Transport .....	63
10.2 Storage .....	63
10.3 Disposal .....	64
<b>11 Technical data</b> .....	<b>65</b>
11.1 Power supply .....	65
11.2 Ambient conditions .....	65
11.3 Weight/dimensions .....	66
11.4 Noise level .....	66
11.5 Application parameters .....	67
11.6 Acceleration and deceleration times .....	68
11.7 Service life for accessories .....	69
<b>12 Rotors, tubes and adapters</b> .....	<b>71</b>
12.1 Rotor A-4-38 .....	71
12.1.1 Rotor A-4-38 with 4 round buckets .....	71
12.1.2 Rotor A-4-38 with 4 rectangular buckets .....	74
12.2 Rotor A-8-17 .....	75
12.3 Rotor F-45-24-11 .....	76
12.4 Rotor F-35-30-17 .....	77
12.5 Rotor F-45-18-17-Cryo .....	78
<b>13 Ordering information</b> .....	<b>79</b>
13.1 Rotor A-4-38 .....	79
13.1.1 Rotor A-4-38 with round buckets .....	79
13.1.2 Rotor A-4-38 with rectangular buckets .....	80
13.2 Rotor A-8-17 .....	80
13.3 Rotor F-45-24-11 .....	81
13.4 Rotor F-35-30-17 .....	81
13.5 Rotor F-45-18-17-Cryo .....	82
13.6 Fuses .....	82
<b>Certificates</b> .....	<b>83</b>

**Table of contents**

Centrifuge 5702/5702 R/5702 RH  
English (EN)

## 1 Operating instructions







### 1.1 Using this manual

- ▶ Read this operating manual completely before using the device for the first time. Observe the instructions for use of the accessories where applicable.
- ▶ This operating manual is part of the product. Please keep it in a place that is easily accessible.
- ▶ Enclose this operating manual when transferring the device to third parties.
- ▶ The current version of the operating manual for all available languages can be found on our webpage [www.eppendorf.com/manuals](http://www.eppendorf.com/manuals).

### 1.2 Danger symbols and danger levels

#### 1.2.1 Danger symbols

The safety instructions in this manual have the following danger symbols and danger levels:

	Biohazard		Explosive substances
	Electric shock		Risk of crushing
	Hazard point		Material damage

#### 1.2.2 Danger levels

<b>DANGER</b>	<i>Will</i> lead to severe injuries or death.
<b>WARNING</b>	<i>May</i> lead to severe injuries or death.
<b>CAUTION</b>	May lead to light to moderate injuries.
<b>NOTICE</b>	May lead to material damage.

### 1.3 Symbols used

Depiction	Meaning
1. 2.	Actions in the specified order
▶	Actions without a specified order
•	List
<i>Text</i>	Display or software texts
	Additional information

**Operating instructions**

Centrifuge 5702/5702 R/5702 RH  
English (EN)

**1.4 Abbreviations used****PCR**

Polymerase Chain Reaction

**rcf**

Relative centrifugal force :  $g$ -force in  $m/s^2$

**rpm**

Revolutions per minute

**UV**

Ultraviolet radiation



## **2 Safety**

### **2.1 Intended use**

The Centrifuge 5702/5702 R/5702 RH is used for the separation of aqueous solutions and suspensions of different densities in approved sample tubes.

The Centrifuge 5702/5702 R/5702 RH is exclusively intended for use indoors. All country-specific safety requirements for operating electrical equipment in the laboratory must be observed.

### **2.2 User profile**

The device and accessories may only be operated by trained and skilled personnel.

Before using the device, read the operating manual and the instructions for use of the accessories carefully and familiarize yourself with the device's mode of operation.

### **2.3 Information on product liability**

In the following cases, the designated protection of the device may be affected. The liability for any resulting damage or personal injury is then transferred to the owner:

- The device is not used in accordance with the operating manual.
- The device is used outside of its intended use.
- The device is used with accessories or consumables that are not recommended by Eppendorf.
- The device is maintained or repaired by persons not authorized by Eppendorf AG.
- The user makes unauthorized changes to the device.

## 2.4 Application limits

### 2.4.1 Declaration concerning the ATEX directive (2014/34/EU)

---



#### **DANGER! Risk of explosion.**

- ▶ Do not operate the device in areas where explosive substances are handled.
  - ▶ Do not use this device to process any explosive or highly reactive substances.
  - ▶ Do not use this device to process any substances which may generate an explosive atmosphere.
- 

Due to its design and the environmental conditions inside the device, the Centrifuge 5702/5702 R/5702 RH is not suitable for use in a potentially explosive atmosphere.

The device may only be used in a safe environment, such as in the open environment of a ventilated laboratory or a fume hood. The use of substances that may contribute to a potentially explosive atmosphere is not permitted. The final decision on the risks associated with the use of such substances lies with the user.

## 2.5 Warnings for intended use

### 2.5.1 Personal injury or damage to device

---



#### **WARNING! Electric shock due to damage to the device or mains/power cord.**

- ▶ Only switch on the device if the device and mains/power cord are undamaged.
- ▶ Only operate devices which have been installed or repaired properly.
- ▶ In case of danger, disconnect the device from the mains/power supply voltage. Disconnect the mains/power plug from the device or the earth/grounded socket. Use the isolating device intended for this purpose (e.g. the emergency switch in the laboratory).



#### **WARNING! Lethal voltages inside the device.**

If you touch any parts which are under high voltage you may experience an electric shock. Electric shocks cause injuries to the heart and respiratory paralysis.

- ▶ Ensure that the housing is closed and undamaged.
- ▶ Do not remove the housing.
- ▶ Ensure that no liquids can penetrate the device.

Only authorized service staff may open the device.



#### **WARNING! Danger due to incorrect voltage supply.**

- ▶ Only connect the device to voltage sources which correspond with the electrical requirements on the name plate.
- ▶ Only use earth/grounded sockets with a protective earth (PE) conductor.
- ▶ Only use the mains/power cord supplied.



**WARNING! Damage to health due to infectious liquids and pathogenic germs.**

- ▶ When handling infectious liquids and pathogenic germs, observe the national regulations, the biosafety level of your laboratory, the material safety data sheets, and the manufacturer's application notes.
- ▶ Use aerosol-tight sealing systems for the centrifugation of these substances.
- ▶ When working with pathogenic germs which belong to a higher risk group, more than one aerosol-tight bioseal must be used.
- ▶ Wear your personal protective equipment.
- ▶ For comprehensive regulations about handling germs or biological material of risk group II or higher, please refer to the "Laboratory Biosafety Manual" (source: World Health Organization, Laboratory Biosafety Manual, the current edition).



**WARNING! Risk of injury when opening or closing the centrifuge lid**

There is a risk of crushing your fingers when opening or closing the centrifuge lid.

- ▶ Do not reach between the device and centrifuge lid when opening or closing the centrifuge lid.
- ▶ Do not reach into the locking mechanism of the centrifuge lid.
- ▶ Open the centrifuge lid fully to ensure that the centrifuge lid cannot slam shut.



**WARNING! Risk of injury from rotating rotor.**

If the emergency release of the lid is activated, the rotor may continue to rotate for several minutes.

- ▶ Wait for the rotor to stop before activating the emergency release.
- ▶ To check, look through the monitoring glass in the centrifuge lid.



**WARNING! Risk of injury from chemically or mechanically damaged accessories.**

Even minor scratches and cracks can lead to severe internal material damage.

- ▶ Protect all accessory parts from mechanical damage.
- ▶ Inspect the accessories for damage before each use. Replace any damaged accessories.
- ▶ Do not use accessories that have exceeded their maximum service life.



**CAUTION! Poor safety due to incorrect accessories and spare parts.**

The use of accessories and spare parts other than those recommended by Eppendorf may impair the safety, functioning and precision of the device. Eppendorf cannot be held liable or accept any liability for damage resulting from the use of accessories and spare parts other than those recommended, or from the improper use of such equipment.

- ▶ Only use accessories and original spare parts recommended by Eppendorf.

**Safety**

Centrifuge 5702/5702 R/5702 RH  
English (EN)

**NOTICE! Damage to the device due to spilled liquids.**

1. Switch off the device.
2. Disconnect the device from the mains/power supply.
3. Carefully clean the device and the accessories in accordance with the cleaning and disinfection instructions in the operating manual.
4. If a different cleaning and disinfecting method is to be used, contact Eppendorf AG to ensure that the intended method will not damage the device.

**NOTICE! Damage to electronic components due to condensation.**

Condensate may form in the device when it has been transported from a cool environment to a warmer environment.

- ▶ After installing the device, wait for at least 3 h. Only then connect the device to the mains/power line.
- 

## 2.5.2 Incorrect handling of the centrifuge

---

**NOTICE! Damage from knocking against or moving the device during operation.**

If the rotor hits against the rotor chamber wall, this will cause considerable damage to the device and rotor.

- ▶ Do not move or knock against the device during operation.
-



### 2.5.3 Incorrect handling of the rotors

---

**WARNING! Risk of injury from improperly attached rotors and rotor lids.**

- ▶ Only centrifuge with the rotor and rotor lid firmly tightened.
  - ▶ If unusual noises occur when the centrifuge starts, the rotor or the rotor lid may not be attached properly. Stop the centrifugation immediately.
- 

**CAUTION! Risk of injury due to asymmetric loading of a rotor.**

- ▶ Load rotors symmetrically with identical tubes.
  - ▶ Only load adapters with suitable tubes.
  - ▶ Always use the same type of tubes (weight, material/density and volume).
  - ▶ Check that loading is symmetrical by balancing the adapters and tubes used with a balance.
- 

**CAUTION! Risk of injury from overloaded rotor.**

The centrifuge is designed for the centrifugation of material with a maximum density of 1.2 g/mL at maximum speed and filling volume and/or load.

- ▶ Do not exceed the maximum load of the rotor.
- 

**NOTICE! Damage to rotors from aggressive chemicals.**

Rotors are high-quality components which withstand extreme stresses. This stability can be impaired by aggressive chemicals.

- ▶ Avoid using aggressive chemicals such as strong and weak alkalis, strong acids, solutions with mercury ions, copper ions and other heavy metal ions, halogenated hydrocarbons, concentrated saline solutions and phenol.
  - ▶ If it is contaminated by aggressive chemicals, clean the rotor and especially the rotor bores immediately using a neutral cleaning agent.
  - ▶ Due to the manufacturing process, color variations may occur on PTFE coated rotors. These color variations do not affect the service life or resistance to chemicals.
- 

**NOTICE! If handled incorrectly, the rotor may fall.**

The swing-bucket rotor may fall if the buckets are used as handles.

- ▶ Remove the buckets before inserting and/or removing a swing-bucket rotor.
  - ▶ Always use both hands to carry the rotor cross.
-

## 2.5.4 Extreme strain on the centrifugation tubes

---



**CAUTION! Risk of injury from overloaded tubes.**

- ▶ Note the loading limits specified by the tube manufacturer.
  - ▶ Only use tubes which are approved by the manufacturer for the required *g*-forces (rcf).
- 



**NOTICE! Risk from damaged tubes.**

Damaged tubes must not be used as this could cause further damage to the device and the accessories and loss of the samples.

- ▶ Visually check all tubes for damage before use.



**NOTICE! Danger due to deformed or brittle tubes. Autoclaving at excessive temperatures can lead to plastic tubes becoming brittle and deformed.**

This could cause damage to the device and the accessories and sample loss.

- ▶ Observe the temperatures specified by the manufacturer when autoclaving tubes.
- ▶ Do not use deformed or brittle tubes.



**NOTICE! Danger due to open tube lids.**

Open tube lids may break off during centrifugation and damage both the rotor and the centrifuge.

- ▶ Carefully seal all tube lids before centrifuging.



**NOTICE! Damage to plastic tubes due to organic solvents.**





When using organic solvents (e.g., phenol, chloroform), the strength of plastic tubes may be reduced and the tubes may become damaged.

- ▶ Observe the manufacturer's information on the chemical resistance of the tubes.
-

**Safety**

Centrifuge 5702/5702 R/5702 RH  
English (EN)

**2.6 Safety instructions on the device**

Symbol	Meaning	Location
	<b>NOTICE</b> ▶ Observe the safety instructions in the operating manual.	Rear of the device
	▶ Observe the operating manual.	
	• Warning: Possible hand injury	Upper side of the device, under the centrifuge lid.
	▶ Always tighten the rotor with the enclosed rotor key.	Upper side of the device, under the centrifuge lid.
	Warning of biological risks when handling infectious liquids or pathogenic germs.	Aerosol-tight fixed-angle rotors: rotor lid Aerosol-tight buckets: cap



**3 Product description**  
**3.1 Product overview**  
**3.1.1 Centrifuge 5702**

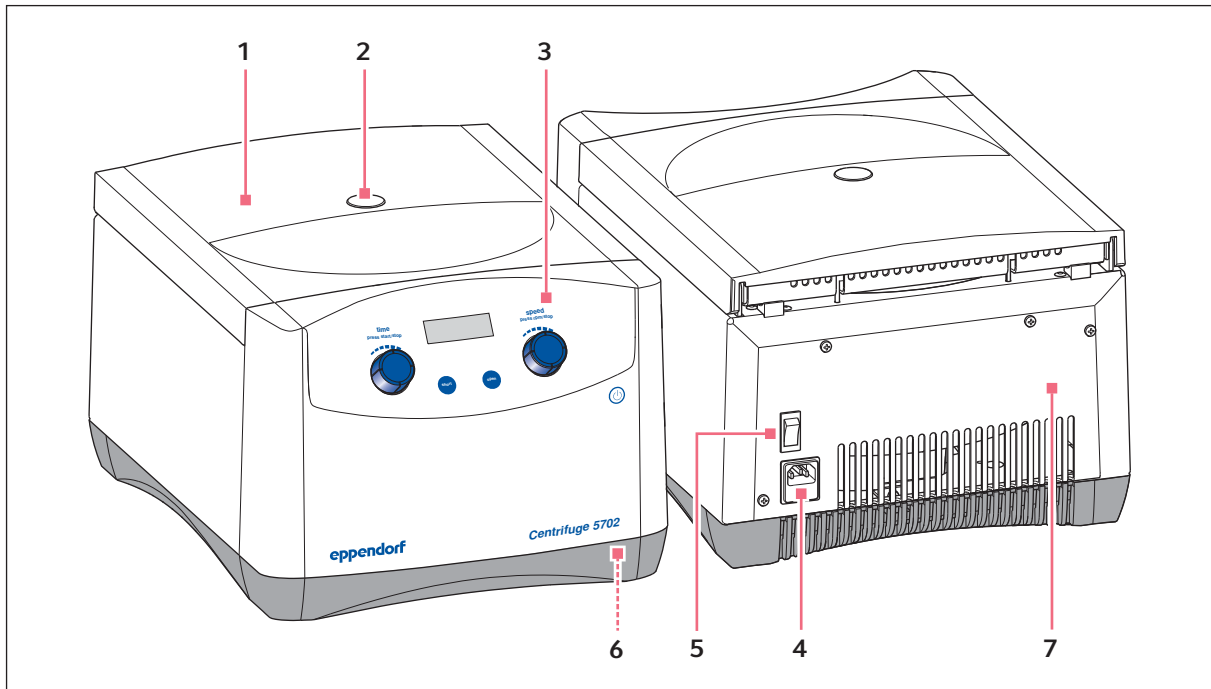

Fig. 3-1: Centrifuge 5702

- |   |  |
|---|--|
| <b>1 Centrifuge lid</b>   | <b>5 Mains/power switch</b><br>Switch for switching the centrifuge on and off. |
| <b>2 Monitoring glass</b><br>Visual inspection for rotor stop and/or facility for a speed check using a stroboscope | <b>6 Emergency release</b>   |
| <b>3 Control panel</b><br>Display, rotary knobs and keys for operating the centrifuge                               | <b>7 Name plate</b>  |
| <b>4 Mains/power cord socket</b><br>Connection for the mains/power cord supplied                                    |  |

**Product description**

Centrifuge 5702/5702 R/5702 RH  
English (EN)

**3.1.2 Centrifuge 5702 R / RH**

Fig. 3-2: Centrifuge 5702 R / RH

- |   |   |
|---|---|
| <p><b>1 Centrifuge lid</b></p> <p><b>2 Monitoring glass</b><br/>Visual inspection for rotor stop and/or facility for a speed check using a stroboscope.</p> <p><b>3 Control panel</b><br/>Display, rotary knobs and keys for operating the centrifuge.</p> <p><b>4 Mains/power cord socket</b><br/>Connection for the mains/power cord supplied</p> | <p><b>5 Mains/power switch</b><br/>Switch for switching the centrifuge on and off.</p> <p><b>6 Emergency release</b></p> <p><b>7 Name plate</b></p> <p><b>8 Condensation water tray</b><br/>For collecting the condensation water from the device</p> |
|---|---|

### 3.2 Delivery package

1	Centrifuge 5702/5702 R/5702 RH
1	Rotor key
1	Mains/power cord
1	Instructions
1	Condensation water tray for Centrifuge 5702 R and Centrifuge 5702 RH
1	Set of fuses

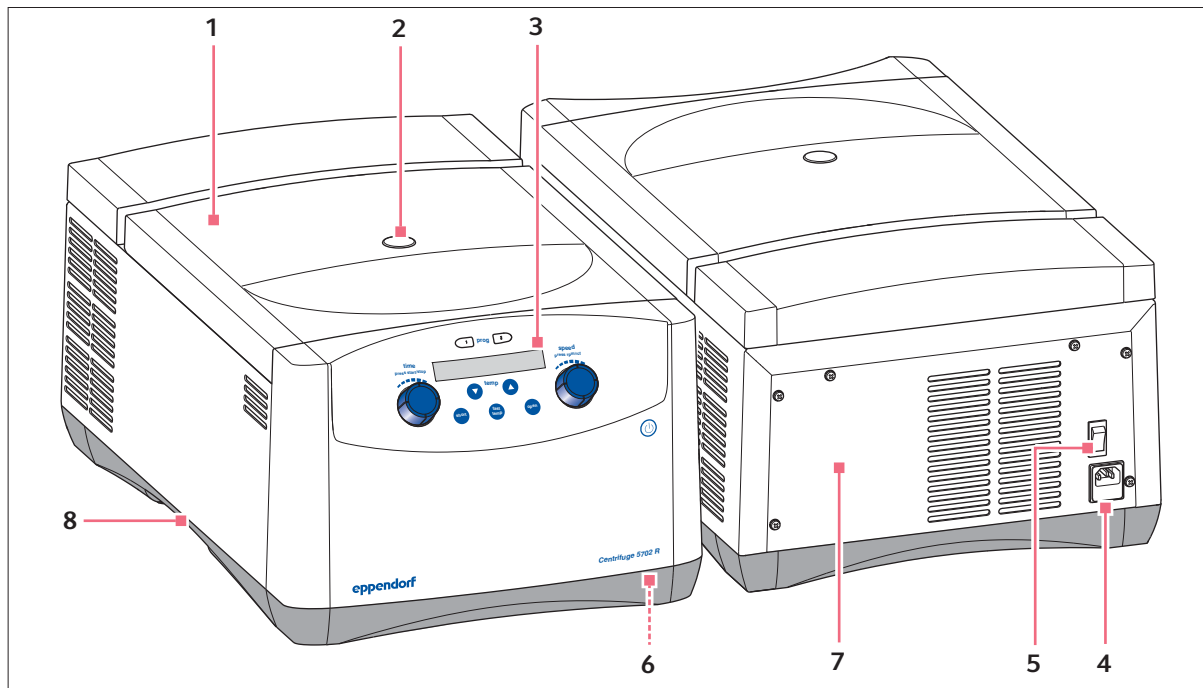

- ▶ Check whether the delivery is complete.
- ▶ Check all parts for any transport damage.
- ▶ To safely transport and store the device, retain the transport box and packing material.

### 3.3 Features

The low-speed centrifuge family 5702 has been especially developed for cell culture laboratories and clinical research laboratories with a low to medium throughput. Due to their compact design these centrifuges fit on nearly all types of lab bench and their quiet operation improves your work environment. They can be operated with six different rotor options to accommodate nearly all types of tubes.

#### The right model for your application:

- Centrifuge 5702 for standard applications
- Cooled model Centrifuge 5702 R for samples which are sensitive to heat
- The cooled and heated model Centrifuge 5702 RH enables centrifuging in the area of molecular biology, improves the viability of the cells, resulting in more accurate results in subsequent applications (e.g. for cell cultivation).

#### Product features

- Maximum speed: 3000 × *g* (4 400 rpm)
- Very compact footprint – fits on any lab bench
- Very quiet operation for a better work environment
- Low height of the device makes loading and unloading of samples easier
- SOFT braking function for slow acceleration and braking. Optimized for cell separation using gradient centrifugation
- The At set rpm function starts the timer when the selected speed has been reached; for reproducible centrifugation
- Key lock prevents unintentional adjustments
- Stainless steel rotor chamber is rust-proof and easy to clean
- Electronic imbalance detection for maximum safety

**Product description**

Centrifuge 5702/5702 R/5702 RH  
English (EN)

**Special features of Centrifuge 5702 R and Centrifuge 5702 RH**

- Centrifuge 5702 R: Temperature settings from -9 °C to 40 °C
- Centrifuge 5702 RH: Temperature settings from -9 °C to 42 °C
- FastTemp function for fast precooling
- Continuous cooling maintains the set temperature of the Centrifuge 5702 R even when the lid is closed
- ECO switch-off function is activated after 8 hours without any operation to reduce energy consumption and to extend the life of the compressor
- Two program keys for storing routine runs
- Active heating ensures high temperature accuracy during the entire centrifugation (Centrifuge 5702 RH only)

### 3.4 Name plate

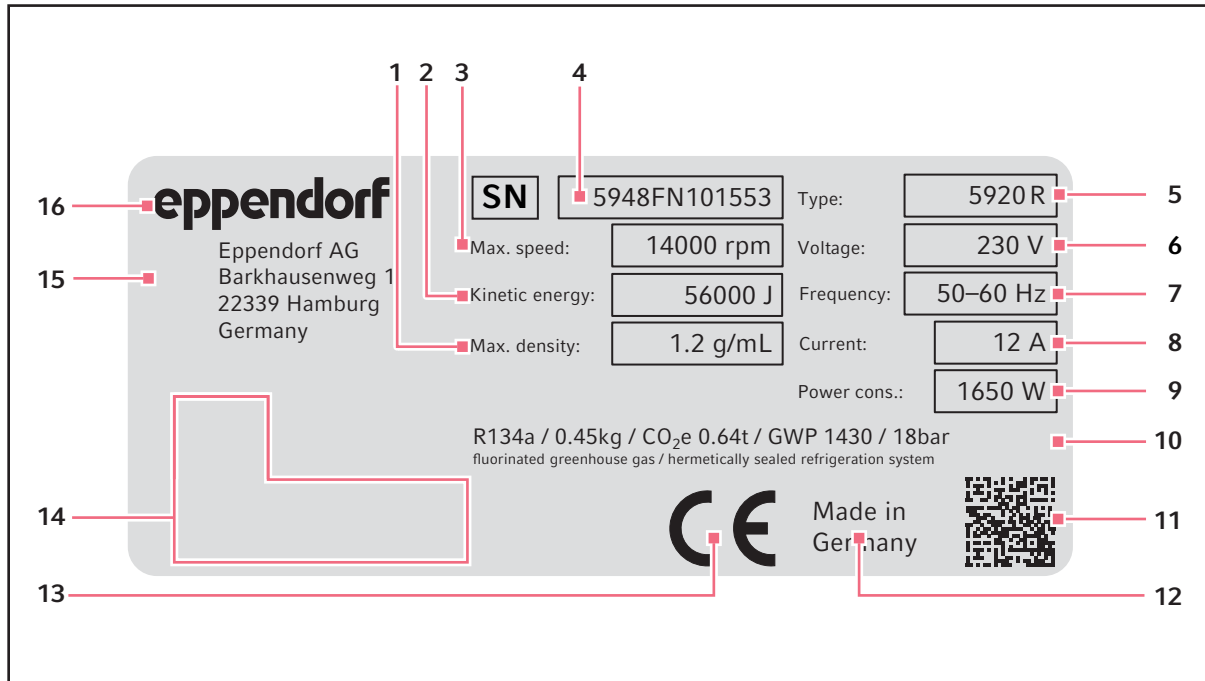







Fig. 3-3: Eppendorf AG device identification (example)

- |   |  |
|---|--|
| <ul style="list-style-type: none"> <li><b>1 Maximum density of the material for centrifuging</b></li> <li><b>2 Maximum kinetic energy</b></li> <li><b>3 Maximum speed</b></li> <li><b>4 Serial number</b></li> <li><b>5 Product name</b></li> <li><b>6 Rated voltage</b></li> <li><b>7 Rated frequency</b></li> <li><b>8 Maximum rated current</b></li> </ul> | <ul style="list-style-type: none"> <li><b>9 Maximum rated power</b></li> <li><b>10 Information on the refrigerant (refrigerated centrifuges only)</b></li> <li><b>11 Data matrix code for serial number</b></li> <li><b>12 Designation of origin</b></li> <li><b>13 CE marking</b></li> <li><b>14 Certification marks and symbols (device-specific)</b></li> <li><b>15 Manufacturer's address</b></li> <li><b>16 Manufacturer</b></li> </ul> |
|---|--|

**Product description**

Centrifuge 5702/5702 R/5702 RH  
English (EN)

Tab. 3-1: Certification and conformity marks and symbols (device-specific)

Symbol/sign	Meaning
	Serial number
	Mark for waste electrical and electronic equipment in accordance with the EN 50419 standard in accordance with directive 2012/19/EU (WEEE) of the European Union
	UL listing certification mark: Representative samples of the device have been tested by Underwriters Laboratories (UL) in accordance with the applicable safety standards for the USA and Canada
	FCC mark of conformity; electromagnetic compatibility tested in accordance with <i>Federal Communications Commission</i> (FCC, USA) regulations
	RoHS mark in accordance with standard SJ/T 11364, <i>Marking for the restriction of the use of hazardous substances in electrical and electronic products</i> , People's Republic of China
	Conformity with the relevant directives for the Eurasian Economic Union

## 4 Installation

### 4.1 Selecting the location

---



**WARNING! Danger due to incorrect voltage supply.**

- ▶ Only connect the device to voltage sources which correspond with the electrical requirements on the name plate.
  - ▶ Only use earth/grounded sockets with a protective earth (PE) conductor.
  - ▶ Only use the mains/power cord supplied.
- 



**NOTICE! If an error occurs, objects in the immediate vicinity of the device may become damaged.**

- ▶ In accordance with the recommendations of EN 61010-2-020, leave a safety clearance of **30 cm** around the device during operation.
- ▶ Please remove all materials and objects from this area.



**NOTICE! Damage due to overheating.**

- ▶ Do not install the device near heat sources (e.g. heating, drying cabinet).
- ▶ Do not expose the device to direct sunlight.
- ▶ Ensure unobstructed air circulation. Maintain a clearance of at least 30 cm around all ventilation gaps.



**NOTICE! Radio interference.**

For devices with Class A noise emission in accordance with EN 61326-1/EN 55011, the following applies: This device has been developed and tested in accordance with CISPR 11 Class A. The device may cause radio interference in domestic environments and is not intended for use in residential areas. The device cannot ensure adequate protection of radio reception in residential areas and domestic environments.

- ▶ If necessary, take appropriate measure to eliminate the interferences.
- 



Mains/power connection for centrifuges: Operation of the centrifuge is only permitted in building installations that comply with the applicable national regulations and standards. In particular, it must be ensured that there are no impermissible loads on the supply lines and assemblies that are located upstream of the internal protection of the device. This can be ensured by additional circuit breakers or other suitable safety elements in the building installation.



The mains/power switch and the disconnecting device of the mains/power line must be easily accessible during operation (e.g. a residual current circuit breaker).

## Installation

Centrifuge 5702/5702 R/5702 RH  
English (EN)

Select the location of the device according to the following criteria:

- Mains/power connection in accordance with the name plate
  - Minimum distance to other devices and walls: 30 cm
  - Resonance free table with horizontal even work surface
  - The surrounding area must be well ventilated.
  - The location is protected against direct sunlight.
- ▶ Do not use this device near strong electromagnetic sources (e.g. unshielded high frequency sources) as they could impede proper functioning of the device.

## 4.2 Preparing installation



### **CAUTION! Risk of injury due to lifting and carrying of heavy loads**

The device is heavy. Lifting and carrying the device can lead to back injuries.

- ▶ Transport and lift the device with an adequate number of helpers only.
- ▶ Use a transport aid for transporting the device.



The device may only be stored and transported in its original packing.

- ▶ Retain the original packing, transport straps, packing material and transport securing devices.
- ▶ Do not cut up the transport straps.

### **Unpacking the centrifuge**

1. Open the transport packing.
2. **Centrifuge 5702:** Remove the covering cardboard.
3. Take the accessories out of the packing.
4. Use the transport straps to lift the centrifuge out of the packing.
5. Place the device on a suitable work surface.
6. Remove the transport straps from the centrifuge.
7. There is a transport securing device attached to the front and the rear panel of the centrifuge. Remove the transport securing devices.
8. Remove the plastic sleeve.
9. **Centrifuge 5702:** The transport securing device for the motor is located underneath the centrifuge. Lift the centrifuge on one side and remove the transport securing device.
10. **Centrifuge 5702 R, Centrifuge 5702 RH:** Insert the condensation water tray.



### 4.3 Installing the instrument

---



**WARNING! Danger due to incorrect voltage supply.**

- ▶ Only connect the device to voltage sources which correspond with the electrical requirements on the name plate.
- ▶ Only use earth/grounded sockets with a protective earth (PE) conductor.
- ▶ Only use the mains/power cord supplied.



**NOTICE! Damage to electronic components due to condensation.**

Condensate may form in the device when it has been transported from a cool environment to a warmer environment.

- ▶ After installing the device, wait for at least 3 h. Only then connect the device to the mains/power line.



**NOTICE! Centrifuge 5702 R, Centrifuge 5702 RH: Compressor damage after improper transport.**

- ▶ After installation, wait 4 hours before switching on the centrifuge.
- 

#### Prerequisites

- The device has been prepared in accordance with the operating manual.
  - The device has adapted to the ambient temperature (waiting time 3 h).
  - The compressor is ready for operation (waiting time 4 h).
1. Connect the mains/power cord of the centrifuge to the mains/power supply.
  2. Switch on the centrifuge using the mains/power switch.
    - The **standby** key lights up green.
    - The display is active.
  3. Open the centrifuge lid using the **open** key.

**Installation**

Centrifuge 5702/5702 R/5702 RH

English (EN)

## 5 Operation

### 5.1 Operating controls

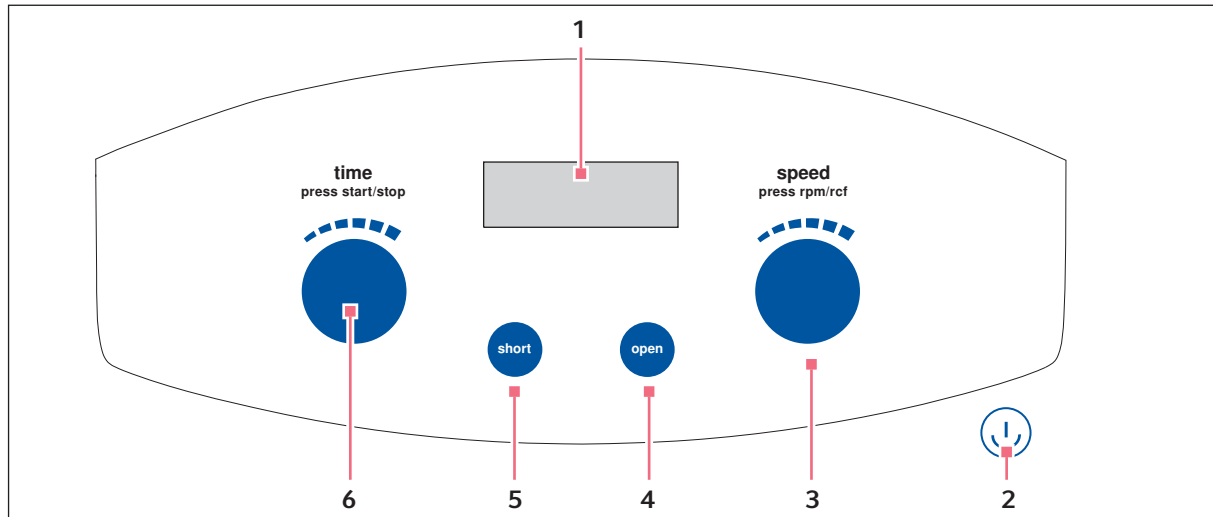



Fig. 5-1: Centrifuge 5702 operating controls

- |   |   |
|---|---|
| <p><b>1 Display</b></p> <p><b>2 Standby  key</b><br/>Activate/deactivate standby mode<br/>Key lights up green: Centrifuge is operational<br/>Key lights up red: Standby mode is active</p> <p><b>3 Rotary knob speed</b><br/>Turn the knob: Set the centrifugation speed.<br/>Press the knob briefly: Switch the display of the centrifugation speed (to rpm or rcf)</p> | <p><b>4 open key</b><br/>Release the lid.</p> <p><b>5 short key</b><br/>Short run centrifugation</p> <p><b>6 Rotary knob time</b><br/>Turn the knob: Set the centrifugation time.<br/>Press the knob: Start or stop the centrifugation.</p> |
|---|---|

**Operation**

Centrifuge 5702/5702 R/5702 RH  
English (EN)

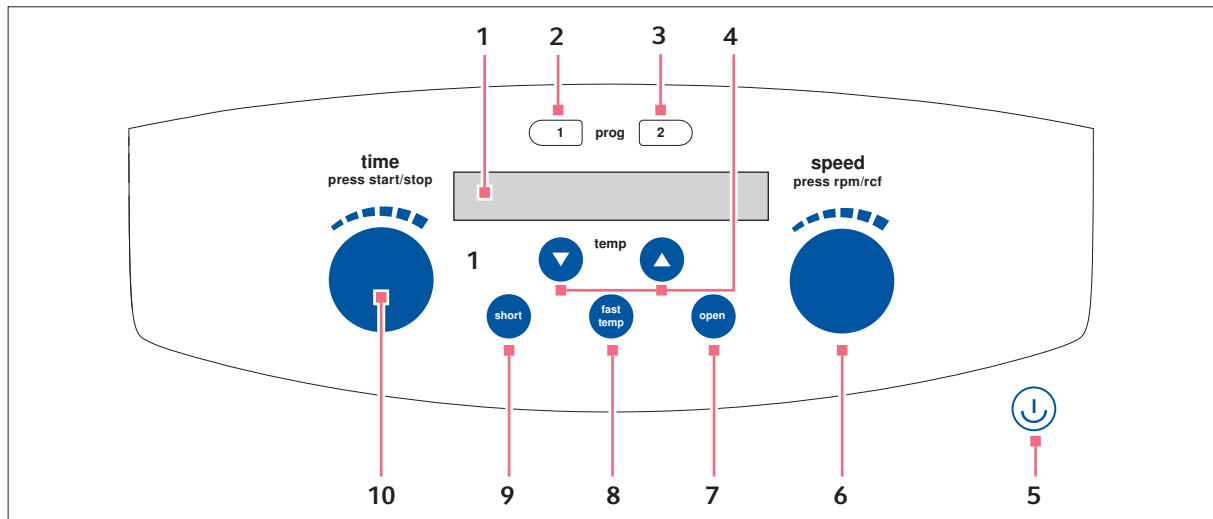



Fig. 5-2: Centrifuge 5702 R/Centrifuge 5702 RH operating controls

- |   |   |
|---|---|
| <p><b>1 Display</b></p>   | <p><b>6 Rotary knob speed</b><br/>Turn the knob: Set the centrifugation speed.<br/>Press the knob: Switch the display of the centrifugation speed (to rpm or rcf)</p> |
| <p><b>2 prog 1 key</b><br/>Press the key briefly: Load program 1.<br/>Press the key for &gt; 2 s: Save current parameters.</p>  | <p><b>7 open key</b><br/>Release the lid.</p>   |
| <p><b>3 prog 2 key</b><br/>Press the key briefly: Load program 2.<br/>Press the key for &gt; 2 s: Save current parameters.</p>  | <p><b>8 fast temp key</b><br/>Start the FastTemp temperature control run.</p>   |
| <p><b>4 temp arrow keys</b><br/>Set the temperature.<br/>Press and hold the arrow key: Quick setting</p>  | <p><b>9 short key</b><br/>Short run centrifugation</p>  |
| <p><b>5 Standby  key</b><br/>Activate/deactivate standby mode<br/>Key lights up green: Centrifuge is operational<br/>Key lights up red: Standby mode is active</p> | <p><b>10 Rotary knob time</b><br/>Turn the knob: Set the centrifugation time.<br/>Press the knob: Start and stop centrifugation.</p>                                  |

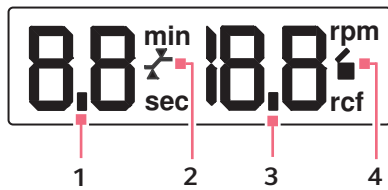

Fig. 5-3: Centrifuge 5702 display

- |  |   |
|--|---|
| <p><b>1 Centrifugation time [min, s]</b><br/>Actual value</p> <p><b>2 At set rpm function</b><br/> : Time counting begins at 95% of the set g-force [rcf] or speed [rpm].<br/> : Time counting begins immediately.</p> | <p><b>3 Rotational speed [rpm] or g-force [rcf]</b><br/>Actual value</p> <p><b>4 Centrifuge status</b><br/> : The centrifuge lid is unlocked.<br/> : The centrifuge lid is locked.<br/>  (Flashes): Centrifugation in progress.</p> |
|--|---|

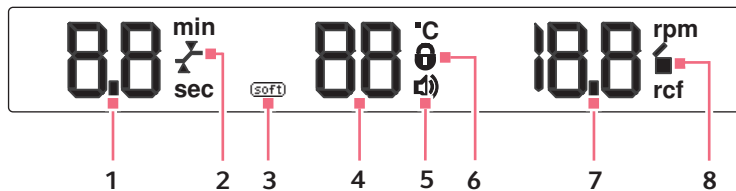

Fig. 5-4: Centrifuge 5702 R/Centrifuge 5702 RH display

- |   |   |
|---|---|
| <p><b>1 Centrifugation time [min, s]</b><br/>Actual value</p> <p><b>2 At set rpm function</b><br/> : Time counting begins at 95% of the set g-force [rcf] or speed [rpm].<br/> : Time counting begins immediately.</p> <p><b>3 Soft ramp</b><br/> : Rotor accelerates and brakes slowly.<br/>         No symbol: Rotor accelerates and brakes rapidly.</p> <p><b>4 Temperature in the rotor chamber [°C]</b><br/>Actual value</p> | <p><b>5 Key lock</b><br/> : Key lock is activated Parameters cannot be changed.<br/> : Key lock is not activated</p> <p><b>6 Speaker</b><br/> : The speaker is switched on.</p> <p><b>7 Rotational speed [rpm] or g-force [rcf]</b><br/>Actual value</p> <p><b>8 Centrifuge status</b><br/> : The centrifuge lid is unlocked.<br/> : The centrifuge lid is locked.<br/>  (Flashes): Centrifugation in progress.</p> |
|---|---|



Only Centrifuge 5702 R: When setting the soft ramp, the symbol only appears on the display as of serial number 03556 and higher.  
For devices with serial numbers < 03556 (see *Setting the soft ramp on p. 37*).

## 5.2 Switching on the centrifuge

### Prerequisites

- The device has been installed in accordance with the operating manual.
1. Switch the centrifuge on using the mains/power switch.
  2. Press the **Standby** key, if required.  
The display shows the parameters of the last run.
  3. Press the **open** key to open the closed centrifuge lid.

## 5.3 Replacing the rotor



### **NOTICE! If handled incorrectly, the rotor may fall.**

The swing-bucket rotor may fall if the buckets are used as handles.

- ▶ Remove the buckets before inserting and/or removing a swing-bucket rotor.
- ▶ Always use both hands to carry the rotor cross.



### **NOTICE! Material damage due to improper rotor insertion.**

The motor shaft or bearing may become damaged if the rotor falls into the motor shaft guides in an uncontrolled manner when it is inserted.

- ▶ Hold the rotor with both hands.
- ▶ Guide the rotor onto the motor shaft.

### 5.3.1 Inserting the rotor

1. Align the peg of the motor shaft.
2. Place the rotor vertically onto the motor shaft from the top.  
The arrows on the rotor show the position of the groove. The pegs of the motor shaft must fit into the groove of the rotor.  
If required, lift the rotor and replace it onto the motor shaft.
3. Insert the rotor key supplied into the rotor nut.
4. Turn the rotor key **clockwise** until the rotor nut is firmly tightened.

### 5.3.2 Removing the rotor

1. Turn the rotor nut **counterclockwise** using the rotor key supplied.
2. Remove rotor by lifting it vertically.

## 5.4 Loading a fixed-angle rotor



**CAUTION! Risk of injury due to asymmetric loading of a rotor.**

- ▶ Load rotors symmetrically with identical tubes.
- ▶ Only load adapters with suitable tubes.
- ▶ Always use the same type of tubes (weight, material/density and volume).
- ▶ Check that loading is symmetrical by balancing the adapters and tubes used with a balance.

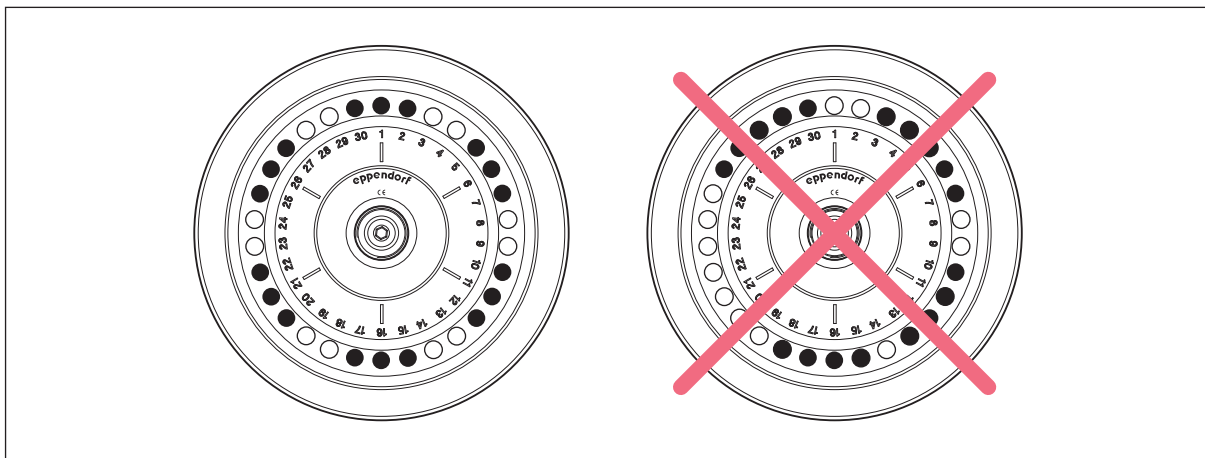

Fig. 5-5: Symmetrical loading of a fixed-angle rotor

1. Check maximum load (adapter, vessel, and contents) for each rotor bore.
2. Load rotors and adapters only with the tubes intended for them.
3. To ensure symmetrical loading, insert sets of two tubes in opposite bores.

Tubes located opposite each other must be of the same type and contain the same filling quantity.

To minimize weight differences between filled sample tubes, we recommend taring with a balance. This will reduce wear of the drive and operating noise.

## 5.5 Loading a swing-bucket rotor



**CAUTION! Risk of injury due to asymmetric loading of a rotor.**

- ▶ Always load all positions of a swing-bucket rotor with buckets.
- ▶ Load buckets symmetrically with identical tubes or plates.
- ▶ Only load adapters with suitable tubes or plates.
- ▶ Always use tubes or plates of the same type (weight, material/density and volume).
- ▶ Check that loading is symmetrical by balancing the adapters and tubes or plates used with a balance.

### 5.5.1 Inserting the bucket in the swing-bucket rotor

#### Prerequisites

- The combination of rotor, bucket, adapter and tube has been approved by Eppendorf.
  - Buckets that are located opposite each other belong to the same weight class. The weight class is engraved in the sides of the groove: e.g., 68.
  - The grooves of the buckets are clean and slightly coated with pivot grease.
1. Check the maximum load (adapter, tube, and contents) for each bucket. Check the length of the tubes. On each rotor there is an indication of the weight that a fully loaded bucket must not exceed.
  2. Insert the bucket into the rotor. Load the rotor symmetrically.  
All rotor positions must be equipped with buckets.  
Only place buckets with the same weight class in opposite locations.
  3. Check to see if all buckets are completely hung and can freely swing out.



- ▶ If you use tubes or plates for the first time, perform a swing-out test.

### 5.5.2 Performing an imbalance calibration

To check whether the buckets can swing out, you can perform a manual swing-out test. The maximum speed of centrifugation is 1000 rpm.

Perform the swing-out test under the following conditions:

- The tubes are used for the first time.
  - Tubes with a length of > 100 mm are used.
1. Equip the buckets with tubes.
  2. Equip the rotor with buckets.
  3. Accelerate the rotor until the buckets swing out up to 90°.

The swing-out test was successful with the following results:

- The buckets swing out freely.
- The tubes do not touch the rotor cross.

### 5.5.3 Loading buckets symmetrically



---

**NOTICE! Material damage due to incorrect equipping of the swing-bucket rotor.**

Incomplete equipping of the swing-bucket rotor or an uneven load will reduce the life span of the rotor and the corresponding buckets considerably.

- ▶ Always load all positions of a swing-bucket rotor with buckets.
  - ▶ Load opposite buckets with the same weight (adapter, tubes, or plates and content).
-



### 5.5.3.1 Equipping buckets with tubes

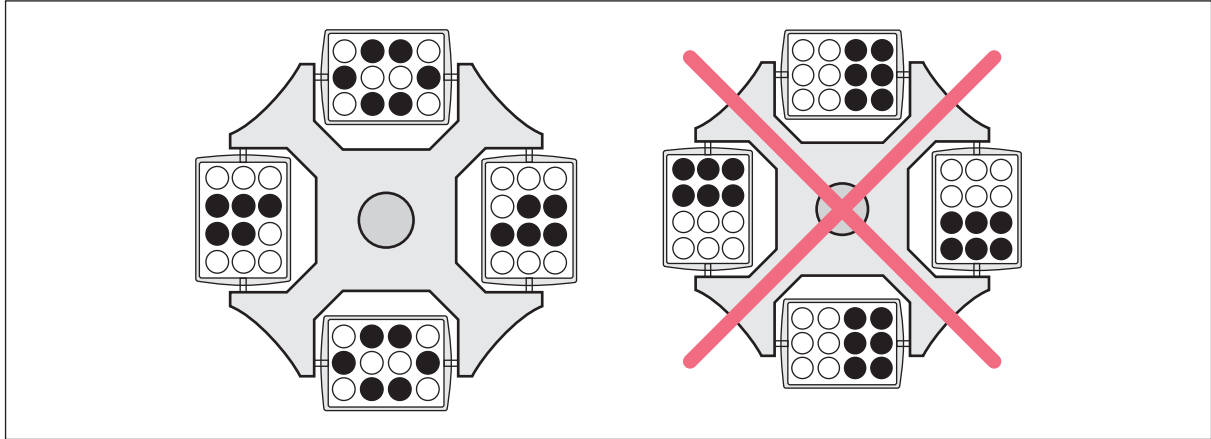

Fig. 5-6: Correct and incorrect loading of the buckets

The loading shown on the right-hand side is incorrect as it places an uneven load on the pegs of the rotor.

- ▶ To reduce vibrations and noise, load all buckets of the swing-buckets rotor equally.

### 5.5.3.2 Closing the round bucket with the cap



**CAUTION! Risk of injury due to chemically damaged rotor lids or caps.**

Transparent rotor lids or caps made of PC, PP or PEI may lose their strength if exposed to organic solvents (e.g., phenol, chloroform).

- ▶ If rotor lids or caps have come into contact with organic solvents, clean them immediately.
- ▶ Regularly check the rotor lids and caps for damage and cracks.
- ▶ Immediately replace rotor lids or caps that show cracks or milky stains.



**NOTICE! Damage to the cap due to organic solvents.**

The cap is made from polycarbonate. Polycarbonate is not resistant to phenol and chloroform. Phenol and chloroform vapors damage the cap and reduce the aerosol tightness.

- ▶ If you are using the cap, do not centrifuge any substances which contain phenol or chloroform.

You can close the round bucket using an aerosol-tight cap.

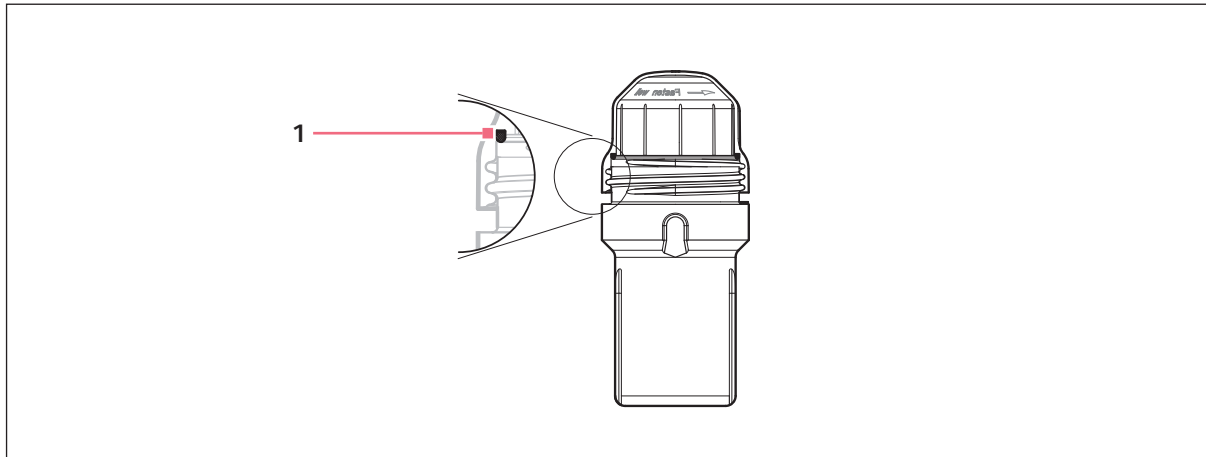

Fig. 5-7: Round bucket with cap

### 1 Sealing ring

1. Check the sealing ring in the cap.  
The sealing ring is not damaged and sits evenly in the groove.
2. Place the cap on the bucket and tighten it.

## 5.6 Closing the centrifuge lid



### **WARNING! Risk of injury when opening or closing the centrifuge lid**

There is a risk of crushing your fingers when opening or closing the centrifuge lid.

- ▶ Do not reach between the device and centrifuge lid when opening or closing the centrifuge lid.
- ▶ Do not reach into the locking mechanism of the centrifuge lid.
- ▶ Open the centrifuge lid fully to ensure that the centrifuge lid cannot slam shut.

1. Check that the rotor is attached correctly.
2. Press the centrifuge lid down until it is gripped by the lid latch. The lid will be closed automatically.
  - The ■ symbol appears on the display.

## 5.7 Centrifugation

Prerequisites:

- The centrifuge is switched on.
- The rotor has been inserted and attached correctly.
- The rotor has been loaded correctly.
- Buckets can swing out freely.
- The centrifuge lid is closed.



**WARNING! Risk of injury from improperly attached rotors and rotor lids.**

- ▶ Only centrifuge with the rotor and rotor lid firmly tightened.
- ▶ If unusual noises occur when the centrifuge starts, the rotor or the rotor lid may not be attached properly. Stop the centrifugation immediately.

### 5.7.1 Centrifugation with time setting

#### 5.7.1.1 Setting the centrifugation parameters

**Setting the centrifugation parameters**

1. Use the rotary knob **time** to set the centrifugation time.
2. Centrifuge 5702 R, Centrifuge 5702 RH: Use the **temp** arrow keys to set the temperature.
3. Use the rotary knob **speed** to set the speed of centrifugation.

**Starting the centrifugation run**

4. To start the centrifugation run, press the **time** rotary knob.

**Display during centrifugation**

- ■ flashes on the display while the rotor is running.
- Remaining run time in minutes. The last minute is counted in seconds.
- Centrifuge 5702 R, Centrifuge 5702 RH: actual temperature in the rotor chamber
- Current *g-force* (rcf) or rotational speed (rpm)

**Changing parameters during the run**

5. To change the following centrifugation parameters during the run, briefly press the **short** key. The display flashes.



During the run you can change the following parameters:

- Centrifugation time  
The shortest new run time that can be set must be 2 min above the elapsed time.
- Centrifuge 5702 R, Centrifuge 5702 RH: temperature
- Centrifugation speed  
During the run, you can switch between the *g-force* and the rotational speed display using the **speed** key.  
The changed centrifugation parameters are adopted after 3 s.

### 5.7.1.2 End of centrifugation

- ▶ To abort the centrifugation, press the **time** rotary knob.
  - The centrifuge stops automatically when the set time has elapsed.
  - During the braking process, the elapsed run time flashes on the display.
  - The signal sounds when the rotor is stopped.
  - To maintain the temperature in the rotor chamber, the centrifuge lid of Centrifuge 5702 R and Centrifuge 5702 RH remains closed. Press the **open** key to open the lid.
  - The centrifuge lid of Centrifuge 5702 opens automatically.

## 5.7.2 Centrifuging in continuous operation

### Setting continuous run

1. In order to centrifuge without any time limits, select the  $\infty$  setting using the **time** rotary knob (before 0.5 min and after 99 min).  
The  $\infty$  icon appears on the display.
2. Centrifuge 5702 R, Centrifuge 5702 RH: Use the **temp** arrow keys to set the temperature.
3. Use the rotary knob **speed** to set the speed of centrifugation.

### Starting continuous run

4. To start the centrifugation run, press the **time** rotary knob.

### Stopping continuous run

5. To stop the centrifugation run, press the **time** rotary knob.
  - During the braking process, the centrifugation time flashes on the display.
  - The signal sounds when the rotor is stopped.
6. To maintain the temperature in the rotor chamber, the centrifuge lid of Centrifuge 5702 R and Centrifuge 5702 RH remains closed. Press the **open** key to open the lid.  
The centrifuge lid of Centrifuge 5702 opens automatically.

## 5.7.3 Short run centrifugation

The short spin centrifugation runs as long as the **short** key is pressed. The centrifugation is performed at maximum rotational speed of the rotor.

1. Centrifuge 5702 R, Centrifuge 5702 RH: Use the **temp** arrow keys to set the temperature.
2. To start the short run centrifugation, press and hold the **short** key.
3. Release the **short** key to end short run centrifugation.  
During the braking process, the centrifugation time flashes on the display.
4. To maintain the temperature in the rotor chamber, the centrifuge lid of Centrifuge 5702 R and Centrifuge 5702 RH remains closed. Press the **open** key to open the lid.  
The centrifuge lid of Centrifuge 5702 opens automatically.

### 5.7.4 Setting the soft ramp

For the Centrifuge 5702/5702 R/5702 RH, 2 settings for soft ramps are available. Use the soft ramps for sensitive applications.

**Prerequisites**

- The centrifuge lid is open.

1. To check which soft ramps are set, briefly press the **short** key.

The display shows the set soft ramps.

Soft ramps	Centrifuge 5702	Centrifuge 5702 R serial number < 03556	Centrifuge 5702 R serial number > 03556	Centrifuge 5702 RH
Fast	<i>br on</i>	<i>br on</i>	No symbol	No symbol
Slow	<i>br OF</i>	<i>br OF</i>	<span style="border: 1px solid black; padding: 2px;">soft</span>	<span style="border: 1px solid black; padding: 2px;">soft</span>

2. Press the **short** key for > 5 s.

The soft ramp setting is changed. The display shows the current status.



3. To change the soft ramp setting again, press the **short** key for > 5 s.

### 5.7.5 Setting the start of the time counting (At set rpm function)

**Prerequisites**

- The centrifuge lid is open.

You can specify when time counting starts.

Start of time counting	Display
time counting begins immediately (setting on delivery)	
Time counting starts when 95% of the <i>g-force</i> or rotational speed has been reached.	

1. Press the **time** key for > 2 s.

The start of the time counting is changed. The display shows the current status.

2. To change the start of the time counting again, press the **time** rotary knob for > 2 s.

**Operation**

Centrifuge 5702/5702 R/5702 RH  
English (EN)

**5.7.6 Calculating the speed of centrifugation**

The *g-force* that is shown on the display is standardized to the A-4-38 rotor with conical tubes 15 mL without adapter. If you use other rotors and adapters, other *g-forces* are reached.



The maximum *g-force* and maximum radius for the respective rotors and adapters can be found in chapter "Rotors, tubes, adapters" (see *Rotors, tubes and adapters* on p. 71).

To calculate the *g-force*, use the following formula in accordance with DIN 58970:

- $rcf = 1.118 \cdot 10^{-5} \cdot n^2 \cdot r_{\max}$ 
  - rcf: *g-force*
  - n: rotational speed in rpm
  - $r_{\max}$ : maximum centrifugation radius in cm

**Example 1**

- The adapter for HPLC vials in the F-45-18-17-Cryo rotor has a maximum radius of 8.3 cm.
- At 6142 rpm, a max. *g-force* of  $3\,500 \times g$  is reached.

**Example 2**

- The 100 mL adapter has a maximum radius of 13.5 cm.
- At 4,000 rpm, a maximum *g-force* of  $2,415 \times g$  is reached.

**5.8 Centrifuge 5702 R, Centrifuge 5702 RH: Heating and cooling**

With Centrifuge 5702 R, the rotor chamber can be cooled. With Centrifuge 5702 RH, the rotor chamber can be heated and cooled.



The temperature that can actually be reached depends on the rotor and the set rotational speed.

In case of a rotor stop (continuous cooling), cooling takes longer than during centrifugation or a temperature control run.



At higher ambient temperatures, a brief fan noise is possible until the set temperature has been reached. Fan noise indicates a heavy cooling performance.

At ambient temperatures of  $< 18^\circ\text{C}$ , a running-in period of approx. 1 h is required for proper operation.

**5.8.1 Setting the temperature****Prerequisites**

- The centrifuge is switched on.

1. Use the **temp** arrow keys to set the target temperature.
2. Set the centrifugation time and speed of centrifugation.
3. To start the centrifugation, press the **time** rotary knob.

The temperature can be changed during centrifugation.

## 5.8.2 Temperature display

Temperature during rotor stop:	The display alternately shows the set temperature (long) and the actual temperature (short)
Temperature display during centrifugation:	actual temperature

## 5.8.3 Temperature monitoring

After the set temperature has been reached, the centrifuge reacts to temperature deviations during centrifugation as follows:

Deviation from the set temperature $> \pm 3 \text{ }^\circ\text{C}$	Temperature display flashes
Deviation from the set temperature $> \pm 5 \text{ }^\circ\text{C}$	Display shows <i>Er 18</i> . Centrifugation is stopped automatically.

The temperature can be changed during centrifugation.

## 5.8.4 Temperature control run FastTemp

Reasons for a temperature control run

- Rotor chamber, rotor and adapter should reach the desired temperature quickly.
- To perform an exactly tempered run, start a short temperature control run immediately before centrifugation. This prevents the temperature in the rotor bowl from overshooting, e.g. after longer downtimes.
- If the centrifuge has been in continuous cooling mode for a long time or at low temperatures, start a short temperature control run before inserting the samples. The temperature control run prevents the samples from freezing.

### 5.8.4.1 Start FastTemp temperature control run

With the FastTemp function, you can immediately start a temperature run without samples, at rotor-specific or temperature-specific speeds. This will quickly bring the rotor chamber, including rotor and adapter, up to the set temperature.

Prerequisites

- The centrifuge is switched on.
  - Rotor, rotor lid and adapter are correctly mounted.
  - The centrifuge lid is closed.
1. Set the speed of centrifugation for the following run.
  2. Use the arrow keys to set the target temperature.
  3. Press the **fast temp** key.

## Operation

Centrifuge 5702/5702 R/5702 RH  
English (EN)

The display shows the following information:

- *FA*
- Actual temperature in the rotor chamber
- Rotational speed

When the set temperature has been reached, the FastTemp temperature control run stops automatically. If the speaker is activated, a periodic alarm sounds.

4. To end the FastTemp temperature control run early, press the **time** rotary knob.



- The centrifuge only stops the FastTemp temperature control run when the rotor is completely tempered. Therefore, there may be a delay between the display of the achieved target temperature and the automatic end of the temperature control run.
- During the temperature control run, the target temperature can be changed using the **temp** arrow keys. Duration and speed of the temperature control run are adapted automatically.

### 5.8.4.2 Temperature control run with aerosol-tight caps

If you perform a temperature control run and close the buckets with aerosol-tight caps, negative pressure builds up in the buckets. After the temperature control run, the caps cannot be removed.

1. Do not use aerosol-tight caps for a temperature control run.
2. Temper buckets and adapters without aerosol-tight caps.

### 5.8.5 Continuous cooling

The continuous cooling keeps the set temperature in the rotor chamber during rotor stop.

- During continuous cooling, the set temperature is displayed.
- Irrespective of the set temperature, the temperature does not go below 4 °C to prevent the rotor chamber from freezing and to prevent condensation.
- In case of a rotor stop, temperature control takes longer than during centrifugation or a temperature control run.
- Continuous cooling stops after 8 h.

Prerequisites

- The centrifuge is switched on.
- The centrifuge lid is closed.
- The set temperature is lower than the ambient temperature.

1. Continuous cooling starts automatically.



### 5.8.6 Centrifuge 5702 RH: Temperature profiles

The Centrifuge 5702 RH has a controlled heating and refrigeration system. This makes it possible to exactly temper sensitive samples.

A special temperature profile is stored in the software for each rotor. The temperature profile defines the speed at which the rotor performs the FastTemp temperature control run. The aim is to temper the rotor chamber and the rotor to the set temperature in the shortest possible time. The temperature is to be maintained, with small tolerances.

Prerequisites

- The centrifuge lid is open.

1. Press the **fast temp** key.

The last selected temperature profile is displayed.

Display	Rotor
<i>ro F 35</i>	Rotor F-35-30-17
<i>ro F 24</i>	Rotor F-45-24-11
<i>ro F 18</i>	Rotor F-45-18-17-Cryo
<i>ro A4 rE</i>	Rotor A-4-38 with rectangular buckets
<i>ro A4 ro</i>	Rotor A-4-38 with round buckets
<i>ro A8</i>	Rotor A-8-17
<i>ro AL L</i>	Temperature profile for all rotors

2. Use the arrow keys to select the temperature profile for the rotor used.

The selected temperature profile is adopted after 3 s. The display shows the default values again.

## 5.9 Aerosol-tight centrifugation



### **WARNING! Damage to health due to limited aerosol tightness with an incorrect rotor/ rotor lid combination.**

Aerosol-tight centrifugation is guaranteed only if the rotors and rotor lids intended for this purpose are used. The designation of aerosol-tight fixed-angle rotors always starts with **FA**. The aerosol-tight rotors and rotor lids of this centrifuge are additionally marked with a red ring on the rotor and a red rotor lid screw.

- ▶ Always use rotors and rotor lids marked aerosol-tight together for aerosol-tight centrifugation. The details specifying in which centrifuge the aerosol-tight rotors and rotor lids may be used can be found on the rotor and on the top of the rotor lid.
- ▶ Only use aerosol-tight rotor lids in combination with the rotors that are specified on the rotor lid.
- ▶ Only use aerosol-tight buckets with the corresponding caps.



### **WARNING! Damage to health due to limited aerosol-tightness if used incorrectly.**

Mechanical stresses and contamination by chemicals or other aggressive solvents may impair the aerosol tightness of the rotors and rotor lids. Autoclaving at excessive temperatures can lead to plastic vessels, adapters and rotor lids becoming brittle and deformed.

- ▶ Check the integrity of the seals of the aerosol-tight rotor lids or caps before each use.
- ▶ Only use aerosol-tight rotor lids or caps if the seals are undamaged and clean.
- ▶ Do not exceed temperatures of 121 °C or a time of more than 20 min. while autoclaving.
- ▶ After each proper autoclaving process (121 °C, 20 min.), coat the threads of the rotor lid screw with a thin layer of pivot grease (order no. Int. 5810 350.050, North America 022634330).
- ▶ Replace aerosol-tight rotor lids without replaceable seals after 50 autoclaving cycles.
- ▶ Only the seal of aerosol-tight rotor lids with exchangeable seals (e.g. QuickLock rotor lids) must be replaced after 50 autoclaving cycles.
- ▶ Replace aerosol-tight rotor caps after 50 autoclaving cycles.
- ▶ **Never** store aerosol-tight rotors or buckets closed.



The aerosol tightness of rotors, rotor lids, buckets and caps has been tested and certified according to Annex AA of IEC 61010-2-020.

### 5.9.1 Aerosol-tight centrifugation in a fixed-angle rotor

To ensure aerosol tightness, the following applies:

- Replace aerosol-tight rotor lids without exchangeable seal and cap after 50 autoclaving cycles.
- Replace the seal of aerosol-tight rotor lids with exchangeable seal (e.g. QuickLock rotor lids) after 50 autoclaving cycles.
- Lightly grease the replaced seal with pivot grease after it is inserted.

## 5.10 Switching off the centrifuge

1. Open the centrifuge lid.  
Residual moisture can evaporate.
2. Remove the aerosol-tight caps from the buckets.
3. Remove rotor lids from fixed-angle rotors.  
Aerosol-tight accessories may not be stored with the lid closed.
4. Switch off the centrifuge using the mains/power switch.

**Operation**



Centrifuge 5702/5702 R/5702 RH  
English (EN)

## 6 Device settings



### 6.1 Changing the operating state

The centrifuge has 2 operating states, the ready state and standby mode. You can actively change between the two operating states.

The **Standby**  key shows the operating state of the device.





- The device is ready for operation: The **Standby**  key lights up green.
- The device is in standby mode: The **Standby**  key lights up red.

Prerequisites

- The centrifuge is not performing a run.
- ▶ Press the **Standby**  key to change the operating state.  
The operating state changes. The **Standby**  key changes color.

### 6.2 Key lock

The display shows whether the key lock is activated.

	Centrifuge 5702	Centrifuge 5702 R	Centrifuge 5702 RH
Key lock is activated	<i>Lo on</i>		
Key lock is deactivated	<i>Lo OF</i>		

If the key lock is activated, the following centrifugation parameters cannot be changed:

- Centrifugation time
- Centrifuge 5702 R, Centrifuge 5702 RH: Temperature
- *g-force* or rotational speed
- Soft ramps
- Status of the At set rpm function

The following settings can be changed despite the key lock being activated:

- Start and stop centrifugation. Press the **time** rotary knob.
- Set the unit for the speed of centrifugation [rpm/ rcf]. Press the **speed** rotary knob.

#### Activating the key lock

Prerequisites

- The centrifuge lid is open.
- ▶ Press the **short** and **open** keys simultaneously for > 5 s.  
The centrifugation parameters cannot be changed.

**Device settings**

Centrifuge 5702/5702 R/5702 RH  
English (EN)

**Deactivating the key lock**

## Prerequisites

- The centrifuge lid is open.
- ▶ Press the **short** and **open** keys simultaneously for > 5 s.  
The centrifugation parameters cannot be changed.

**6.2.1 Centrifuge 5702 R, Centrifuge 5702 RH: Securing the program against changes**

1. Use the **prog 1** or **prog 2** key to select the program.
2. Activate the key lock. Press the **short** and **open** keys simultaneously for > 5 s.  
The program cannot be changed.

**6.2.2 Centrifuge 5702: Displaying the key lock status**

On the Centrifuge 5702 R and the Centrifuge 5702 RH, the key lock status is shown on the display.

## Prerequisites

- The centrifuge lid is open.
- ▶ Shortly press the **short** and **open** keys simultaneously.  
The display shows the current status of the key lock.

**6.3 Speakers**

The display shows if the speakers are switched on.

	<b>Centrifuge 5702</b>	<b>Centrifuge 5702 R</b>	<b>Centrifuge 5702 RH</b>
Speakers switched on	<i>b on</i>	🔊	🔊
Speakers switched off	<i>b OF</i>	no symbol	no symbol

**Switching on the speakers**

## Prerequisites

- The centrifuge lid is open.
- ▶ Press the **open** key for > 2 s.  
The speakers are switched on.

**Switching off the speakers**

## Prerequisites

- The centrifuge lid is open.
- ▶ Press the **open** key for > 2 s.

### 6.3.1 Display the status of the speakers

This function is only available for the Centrifuge 5702. On the Centrifuge 5702 R and the Centrifuge 5702 RH the status of the speakers is shown on the display.

#### Prerequisites

- The centrifuge lid is open.
- ▶ Press the **open** key briefly.  
The display shows the status of the speakers.

**Device settings**

Centrifuge 5702/5702 R/5702 RH

English (EN)



## 7 Programs

You can store 2 programs each on the Centrifuge 5702 R and on the Centrifuge 5702 RH.

You can set the following parameters for each program:

- Centrifugation time
- Temperature
- Centrifugation speed
- Start of time measurement (function At set rpm)
- Settings for the soft ramp

### 7.1 Creating and storing a program

You can store two programs on the device

Prerequisites

- Rotor stop.
1. Use the rotary knob **time** to set the centrifugation time.
  2. Use the **temp** arrow keys to set the temperature.
  3. Use the rotary knob **speed** to set the speed of centrifugation.
  4. Set the start of time counting (function At set rpm). Press rotary knob **time** > 2 s to do this.
  5. Press the **short** key > 5 s to set the soft ramp.
  6. Select the program slot. Press the **prog 1** key or the **prog 2** key > 2 s.
    - A signal sounds.
    - The program key does not flash any more. The program key lights up blue.
    - The parameters of the program are saved.

### 7.2 Saving the current settings as a program

You can save the current settings as a program.

Prerequisites

- Rotor stop.
- ▶ Press the **prog 1** key or the **prog 2** key > 2 s.
- A signal sounds.
  - The program key lights up blue.
  - The parameters of the program are saved.

## Programs

Centrifuge 5702/5702 R/5702 RH  
English (EN)

### 7.3 Calling up a program

You can call up stored programs.

Prerequisites

- Rotor stop.
- ▶ Press the **prog 1** key or **prog 2** key to call up a program.
  - The program key lights up blue.
  - The display shows the parameters of the program.

### 7.4 Editing programs

You can overwrite stored programs.



If a program is loaded, the parameters cannot be changed. The following text appears in the display - *Pr 1* for program 1 or *Pr 2* for program 2.

Prerequisites

- The program has been created and stored.
  - The program has been called up. The program key **prog 1** or **prog 2** lights up blue.
1. Press the key again on which the program has been stored.
    - The program key does not light up any more.
    - The display shows the centrifugation parameters.
    - The centrifugation parameters can be adjusted.
  2. Change the centrifugation parameters.
  3. Store the program on the old program slot. Press the **prog 1** key or **prog 2** > 2 s to do this.
    - A signal sounds.
    - The program key does not flash any more. The program key lights up in blue.
    - The parameters of the program are saved.

### 7.5 Deleting programs

Programs 1 and 2 cannot be deleted. The programs can be overwritten.

### 7.6 Exiting the program

Prerequisites

- The program has been called up. The program key **prog 1** or **prog 2** lights up blue.
1. Press the **prog 1** key or the **prog 2** key to exit the program.
    - The program key does not light up any more.
    - The display shows the centrifugation parameters.
    - The centrifugation parameters can be adjusted.

## 8 Maintenance

### 8.1 Service



**WARNING! Risk of fire or electrical shock**

- ▶ Have the centrifuge's electrical safety, especially the paths for the protective connections, checked every 12 months by trained and skilled personnel.

We recommend to have the centrifuge and the associated rotors checked by Technical Service during a service at least every 12 months. Please note the country-specific regulations.

### 8.2 Preparing cleaning/disinfection

- ▶ Clean all accessible surfaces of the device and the accessories at least weekly and when contaminated.
- ▶ Clean the rotor regularly. This way the rotor is protected and the durability is prolonged.
- ▶ Furthermore, observe the notes on decontamination (see *Decontamination before shipment on p. 55*) when the device is sent to the authorized Technical Service for repairs.

The procedure described in the following chapter applies to the cleaning as well as to the disinfection or decontamination. The table below describes the steps required on top of this:

Cleaning	Disinfecting/decontamination
<ol style="list-style-type: none"> <li>1. Use a mild cleaning fluid to clean the accessible surfaces of the device and the accessories.</li> <li>2. Carry out the cleaning as described in the following chapter.</li> </ol>	<ol style="list-style-type: none"> <li>1. Choose the disinfection method which corresponds to the legal regulations and guidelines in place for your range of application. For example, use alcohol (ethanol, isopropanol) or alcohol-based disinfectants.</li> <li>2. Carry out the disinfection or decontamination as described in the following chapter.</li> <li>3. Then clean the device and the accessories.</li> </ol>



If you have any further questions regarding the cleaning and disinfection or decontamination or regarding the cleaning fluid to be used, contact the Eppendorf AG Application Support. The contact details are provided on the back of this manual.

### 8.3 Cleaning/disinfection

---

**DANGER! Electric shock due to the ingress of liquid.**

- ▶ Switch off the device and disconnect it from the mains/power line before starting cleaning or disinfection.
  - ▶ Do not allow any liquids to penetrate the inside of the housing.
  - ▶ Do not perform a spray clean/spray disinfection on the housing.
  - ▶ Only reconnect the device to the mains/power line when it is completely dry, both inside and outside.
- 

**NOTICE! Damage from the use of aggressive chemicals.**

- ▶ Do not use any aggressive chemicals on the device or its accessories, such as strong and weak bases, strong acids, acetone, formaldehyde, halogenated hydrocarbons or phenol.
  - ▶ If the device has been contaminated by aggressive chemicals, clean it immediately using a mild cleaning agent.
- 

**NOTICE! Corrosion due to aggressive cleaning agents and disinfectants.**

- ▶ Do not use any corrosive cleaning agents, aggressive solvents or abrasive polishes.
  - ▶ Do not incubate the accessories in aggressive cleaning agents or disinfectants for longer periods.
- 

**NOTICE! Damage from UV and other high-energy radiation.**

- ▶ Do not use UV, beta, gamma, or any other high-energy radiation for disinfection.
  - ▶ Avoid storage in areas with strong UV radiation.
- 

**Autoclaving**

Fixed-angle rotors and adapters can be autoclaved (121 °C, 20 min).

Rotor crosses of swing-bucket rotors cannot be autoclaved.

After a maximum of 50 autoclaving cycles, the aerosol-tight caps must be exchanged.

### 8.3.1 Cleaning and disinfecting the device

#### Cleaning agent:

- alcohol 70% (ethanol, isopropanol)
- mild neutral cleaning agent
- lint-free cloth

1. Open the lid.
2. Switch off the device and disconnect it from the voltage supply.
3. Remove the rotor.
4. Clean and disinfect all accessible surfaces of the device, including the mains/power cord, using a damp cloth and the cleaning agents.
5. Thoroughly clean the rubber seal of the rotor chamber with water.
6. Let the rubber seal dry off.
7. Rub the dry rubber seal with glycerol or talcum. This prevents the rubber seal from becoming brittle. Other components of the device, such as the motor shaft and rotor cone, must not be lubricated.
8. Clean the motor shaft with a soft, dry, lint-free cloth.
9. Check the motor shaft for damage.
10. Check the device for corrosion and damage.
11. Leave the centrifuge lid open when the device is not in use.
12. Only connect the device to the mains/power supply if it is completely dry on the inside and outside.

### 8.3.2 Cleaning and disinfecting the rotor

1. Inspect the rotor and accessories for damage and corrosion. Do not use damaged rotors or accessories.
2. Clean and disinfect the rotors and accessories with the recommended cleaning agents.
3. Clean and disinfect the rotor bores with a bottle brush.
4. Rinse the rotors and accessories thoroughly with distilled water. Rinse the rotor bores of fixed-angle rotors particularly thoroughly.



Do not immerse the rotor in liquid as liquid can get trapped inside the cavities.

5. Place the rotors and accessories on a towel to dry. Place the fixed-angle rotors with the rotor bores facing down so the bores can dry.
6. Clean the rotor cone with a soft, dry, lint-free cloth. Do not lubricate the rotor cone.
7. Inspect the rotor cone for damage.
8. Place the dry rotor onto the motor shaft.
9. Tighten the rotor nut firmly by turning it **clockwise** with the rotor key.
10. If necessary, equip the fixed-angle rotor with the cleaned adapters.
11. Equip the swing-bucket rotor with the cleaned buckets and adapters.

## 8.4 Additional care instructions for refrigerated centrifuges.

- ▶ Empty and clean the condensation water tray regularly and especially after liquid spillage in the rotor chamber. Pull out the condensation water tray at the front right under the device.
- ▶ Empty and clean the condensation water tray regularly. Pull out the condensation water tray to the left under the device.
- ▶ Regularly clear the rotor chamber of ice formations via defrosting, either by leaving the centrifuge lid open or carrying out a brief temperature control run at approx. 30°C.
- ▶ To relieve the gas springs in the centrifuge lid, leave the centrifuge lid open when not in use for a long period.  
Residual moisture can escape.
- ▶ Leave the centrifuge lid open when not in use for a long period.  
Residual moisture can escape. The lid spring is relieved.
- ▶ Wipe up condensation water in the rotor chamber. Use a soft absorbent cloth for this.
- ▶ No later than every 6 months, remove any dust deposits from the ventilation gaps of the centrifuge using a brush or swab. First switch off the centrifuge and remove the mains/power plug.

## 8.5 Cleaning glass breakage

When using glass tubes there is a risk of glass breakage in the rotor chamber. The resulting glass splinters are swirled around in the rotor chamber during centrifugation and have a sandblasting effect on the rotor and accessories. The smallest glass particles become lodged in the rubber parts (e.g., the motor guide, the rotor chamber seal, and the rubber mats of adapters).



### **NOTICE! Glass breakage in the rotor chamber**

Glass tubes in the rotor chamber may break if the  $g$ -force is too high. Broken glass can damage the rotor, accessories and samples.

- ▶ Please note the manufacturer's information on the recommended centrifugation parameters (load and speed).

### **Effects of glass breakage in the rotor chamber:**

- Fine black metal abrasion in the rotor chamber (in metal rotor chambers)
- The surfaces of the rotor chamber and accessories are scratched.
- The chemical resistance of the rotor chamber is reduced.
- Contamination of samples
- Wear on rubber parts

### **How to proceed in case of glass breakage**

1. Remove all splinters and glass powder from the rotor chamber and accessories.
2. Thoroughly clean the rotor and rotor chamber. Thoroughly clean the bores of the fixed-angle rotors, in particular.
3. If required, replace the rubber mats and adapters to prevent any further damage.
4. Regularly check the rotor bores for deposits and damage.

## 8.6 Replacing the fuses

The holder is located below the mains/power connection.

1. Switch off the device and isolate it from the mains/power supply.
2. Pull the fuse holder out of the device.
3. Replace the fuses.

## 8.7 Decontamination before shipment

If you are shipping the device to the authorized Technical Service for repairs or to your authorized dealer for disposal please note the following:



**WARNING! Risk to health from contaminated device.**

1. Observe the information in the decontamination certificate. It is available as a PDF document on our webpage ([www.eppendorf.com/decontamination](http://www.eppendorf.com/decontamination)).
  2. Decontaminate all the parts you are going to dispatch.
  3. Include the fully completed decontamination certificate in the shipment.
-

**Maintenance**

Centrifuge 5702/5702 R/5702 RH  
English (EN)



## 9 Troubleshooting

If you cannot remedy an error with the recommended measures, please contact your local Eppendorf partner. The contact address can be found on the Internet at [www.eppendorf.com](http://www.eppendorf.com).

### 9.1 General errors

Problem	Cause	Solution
No display.	No mains/power connection.	▶ Check the mains/power connection.
	Mains/power outage.	▶ Check the fuse of the centrifuge. ▶ Check the mains/power fuse of the lab.
Centrifuge lid cannot be opened.	The rotor is still running.	▶ Wait for the rotor to stop.
	Mains/power outage.	1. Check the fuse of the centrifuge. 2. Check the mains/power fuse of the lab. 3. Activate the emergency lid release.
Centrifuge cannot be started.	The centrifuge lid is not closed.	▶ Close the centrifuge lid.
Centrifuge shakes when it starts up.	The rotor is loaded asymmetrically.	1. Stop the centrifuge and load symmetrically. 2. Restart the centrifuge.
Temperature display flashes. (only Centrifuge 5702 R, Centrifuge 5702 RH)	Temperature deviation from set value: $\pm 3$ °C.	▶ Check the settings. ▶ Check unhindered air circulation through the air slots. ▶ Thaw ice or switch off the centrifuge and allow it to cool down.
The standby key lights up red.	• Centrifuge not ready for operation.	▶ Press the <b>Standby</b> key.

## 9.2 Error messages

If an error message appears, proceed as follows:

- Remedy the fault as described in the "Solution" column.
- Press the **open** key to clear the error message from the display.
- If necessary, repeat centrifugation.

Code	Problem	Cause	Solution
LID		<ul style="list-style-type: none"> <li>• The lid has not been released.</li> </ul>	<ul style="list-style-type: none"> <li>▶ Close the lid.</li> <li>▶ Press the rotary knob <b>start/stop</b>.</li> <li>▶ Open the lid using the emergency release, if required.</li> </ul>
LID		<ul style="list-style-type: none"> <li>• Lid has not been locked.</li> </ul>	<ul style="list-style-type: none"> <li>▶ Close the lid.</li> </ul>
Er 2	Device does not start.	<ul style="list-style-type: none"> <li>• Rotor is loaded asymmetrically.</li> </ul>	<ul style="list-style-type: none"> <li>▶ Load the rotor symmetrically.</li> </ul>
Er 3	The centrifuge decelerates without braking.	<ul style="list-style-type: none"> <li>• The tubes touch the centrifuge lid.</li> </ul>	<ul style="list-style-type: none"> <li>▶ Check the tubes.</li> <li>▶ Switch off the device.</li> <li>▶ Switch on the device and wait for approx. 5 min.</li> <li>▶ Repeat the run.</li> </ul>
Er 3-0	After switching on, the display shows Er 3.	<ul style="list-style-type: none"> <li>• The tubes touch the centrifuge lid.</li> </ul>	
Er 3-2	The centrifuge decelerates with braking.	<ul style="list-style-type: none"> <li>• Error in the electronics.</li> </ul>	<ul style="list-style-type: none"> <li>▶ Switch off the device.</li> <li>▶ Switch on the device and wait for approx. 5 min.</li> <li>▶ Repeat the run.</li> </ul>
Er 3-3	The centrifuge decelerates without braking.	<ul style="list-style-type: none"> <li>• Error in the electronics.</li> </ul>	
Er 5	The centrifuge decelerates without braking.	<ul style="list-style-type: none"> <li>• Error in the lid latch.</li> </ul>	<ul style="list-style-type: none"> <li>▶ Close the lid.</li> <li>▶ Repeat the run.</li> </ul>
Er 5-1 – Er 5-3	Run was started. The rotor rotates.	<ul style="list-style-type: none"> <li>• Error in the lid latch.</li> </ul>	
Er 6 – Er 6-6	The centrifuge decelerates without braking.	<ul style="list-style-type: none"> <li>• Error in the electronics.</li> </ul>	<ul style="list-style-type: none"> <li>▶ Allow device to cool down.</li> <li>▶ Repeat the run.</li> </ul>

<b>Code</b>	<b>Problem</b>	<b>Cause</b>	<b>Solution</b>
Er 7 – Er 7-2	The centrifuge decelerates without braking.	<ul style="list-style-type: none"> <li>• The maximum speed of the rotor is exceeded.</li> <li>• The actual rotational speed of the rotor deviates from the set value. The tolerance is exceeded.</li> </ul>	<ul style="list-style-type: none"> <li>▶ Check if the mains/ power supply voltage corresponds with the technical data.</li> </ul>
Er 8	The centrifuge brakes.	<ul style="list-style-type: none"> <li>• Error occurs when the device accelerates or brakes.</li> </ul>	<ul style="list-style-type: none"> <li>▶ Repeat the run.</li> </ul>
Er 9 – Er 9-4	The data of a run is not saved.	<ul style="list-style-type: none"> <li>• Error in the electronics.</li> </ul>	
Er 10 – Er 10-5	The data of the last run is not saved.	<ul style="list-style-type: none"> <li>• Error in the electronics.</li> </ul>	
Er 11	The centrifuge decelerates without braking.	<ul style="list-style-type: none"> <li>• Mains/power outage during a run.</li> <li>• Error in the electronics.</li> </ul>	<ul style="list-style-type: none"> <li>▶ Check the mains/ power cord.</li> <li>▶ Repeat the run.</li> </ul>
Er 14	The centrifuge can no longer be operated.	<ul style="list-style-type: none"> <li>• Error in the electronics.</li> </ul>	<ul style="list-style-type: none"> <li>▶ Restart the device.</li> </ul>
Er 15/Inb	The centrifuge switches off and decelerates without braking.	<ul style="list-style-type: none"> <li>• Rotor is loaded asymmetrically.</li> </ul>	<ul style="list-style-type: none"> <li>▶ Load the rotor symmetrically.</li> <li>▶ Repeat the run.</li> </ul>
Er 16 – Er 16-2	The centrifuge switches off and decelerates without braking.	<ul style="list-style-type: none"> <li>• Error in the electronics.</li> </ul>	<ul style="list-style-type: none"> <li>▶ Check the tubes.</li> <li>▶ Switch off the device.</li> <li>▶ Switch on the device and wait for 5 min.</li> <li>▶ Repeat the run.</li> </ul>
Er 17 – Er 17-2	The centrifuge switches off and decelerates without braking.	<ul style="list-style-type: none"> <li>• Error in the electronics.</li> </ul>	<ul style="list-style-type: none"> <li>▶ Allow device to cool down.</li> <li>▶ Repeat the run.</li> </ul>
Er 18 – Er 18-3	The centrifuge switches off and decelerates without braking. (only Centrifuge 5702 R, Centrifuge 5702 RH)	<ul style="list-style-type: none"> <li>• The temperature in the rotor chamber deviates from the set temperature by more than 5 °C.</li> </ul>	<ul style="list-style-type: none"> <li>▶ Check the ambient temperature.</li> <li>▶ Check if the device is exposed to direct sunlight.</li> <li>▶ Check if there is sufficient clearance around the device.</li> </ul>
Er 19 – Er 19-1	The cooling aggregate is switched off. The fan continues to run. (only Centrifuge 5702 R, Centrifuge 5702 RH)	<ul style="list-style-type: none"> <li>• Error in the cooling circuit.</li> </ul>	<ul style="list-style-type: none"> <li>▶ Check if the air can circulate through the ventilation slots.</li> <li>▶ Check if there is sufficient clearance around the device.</li> </ul>

**Troubleshooting**

Centrifuge 5702/5702 R/5702 RH  
English (EN)

Code	Problem	Cause	Solution
Er 20	The centrifuge switches off and decelerates with braking. The cooling aggregate is switched off. (only Centrifuge 5702 R, Centrifuge 5702 RH)	<ul style="list-style-type: none"> <li>• Error in the electronics</li> </ul>	<ul style="list-style-type: none"> <li>▶ Repeat the run.</li> </ul>
Er 21	The centrifuge switches off and decelerates with braking.	<ul style="list-style-type: none"> <li>• Error in the electronics</li> </ul>	
Er 22	The fan is switched. The error is only displayed if the centrifuge does not perform a run.	<ul style="list-style-type: none"> <li>• Error in the electronics.</li> </ul>	<ul style="list-style-type: none"> <li>▶ The device can be used.</li> </ul>
Er 23	The centrifuge decelerates without braking.	<ul style="list-style-type: none"> <li>• The ambient temperature is too high.</li> <li>• The motor is too hot.</li> </ul>	<ul style="list-style-type: none"> <li>▶ Check the ambient temperature.</li> <li>▶ Let the motor cool down.</li> <li>▶ Repeat the run.</li> </ul>
Er 24 – Er 24-3	The centrifuge switches off and decelerates with braking. (only Centrifuge 5702 R, Centrifuge 5702 RH)	<ul style="list-style-type: none"> <li>• Error in the cooling aggregate.</li> </ul>	<ul style="list-style-type: none"> <li>▶ Allow device to cool down.</li> </ul>
Er 25/Int		<ul style="list-style-type: none"> <li>• Mains/power outage during a run.</li> <li>• The mains/power supply voltage fluctuates.</li> <li>• The mains/power supply voltage does not correspond with the technical data.</li> </ul>	<ul style="list-style-type: none"> <li>▶ Check the mains/power cord.</li> <li>▶ Wait until the rotor stops rotating.</li> <li>▶ Repeat the run.</li> </ul>
Er 27		<ul style="list-style-type: none"> <li>• Error in the electronics.</li> </ul>	<ul style="list-style-type: none"> <li>▶ Repeat the run.</li> </ul>

### 9.3 Emergency release

If the centrifuge lid cannot be opened, you can activate the emergency release manually.



**WARNING! Risk of injury from rotating rotor.**

If the emergency release of the lid is activated, the rotor may continue to rotate for several minutes.

- ▶ Wait for the rotor to stop before activating the emergency release.
  - ▶ To check, look through the monitoring glass in the centrifuge lid.
- 

The emergency release consists of a cord with a plastic knob. The emergency release is located in the bottom panel at the front right device foot.

1. Disconnect the device from the mains/power supply.
2. Wait for the rotor to stop.
3. Push the centrifuge to the edge of the bench so that the bottom panel can be accessed from underneath at the front right device foot.
4. Remove the plastic button from the bottom panel.
5. Pull the cord downwards vertically.  
The centrifuge lid opens.
6. To prepare the emergency release for its next use, push the cord all the way back into the housing.
7. Insert the plastic knob in the bottom panel.

**Troubleshooting**

Centrifuge 5702/5702 R/5702 RH  
English (EN)

**10 Transport, storage and disposal**  
**10.1 Transport**



**CAUTION! Risk of injury due to lifting and carrying of heavy loads**  
 The device is heavy. Lifting and carrying the device can lead to back injuries.

- ▶ Transport and lift the device with an adequate number of helpers only.
- ▶ Use a transport aid for transporting the device.

- ▶ Remove the rotor from the centrifuge before transport.
- ▶ Use the original packing for transport.

	Air temperature	Relative humidity	Atmospheric pressure
General transport	-25 °C – 60 °C	10 % – 75 %	30 kPa – 106 kPa
Air freight	-20 °C – 55 °C	10 % – 75 %	30 kPa – 106 kPa

**10.2 Storage**

	Air temperature	Relative humidity	Atmospheric pressure
In transport packing	-25 °C – 55 °C	10 % – 75 %	70 kPa – 106 kPa
Without transport packing	-5 °C – 45 °C	10 % – 75 %	70 kPa – 106 kPa

### 10.3 Disposal

If the product needs to be disposed of, the relevant legal regulations must be observed.

**Information on the disposal of electrical and electronic devices in the European Community:**

Within the European Community, the disposal of electrical devices is regulated by national regulations based on EU Directive 2012/19/EU pertaining to waste electrical and electronic equipment (WEEE).

According to these regulations, any devices supplied after August 13, 2005, in the business-to-business sphere, to which this product is assigned, may no longer be disposed of in municipal or domestic waste. To document this, they have been marked with the following marking:



Because disposal regulations may differ from one country to another within the EU, please contact your supplier if necessary.



## 11 Technical data

### 11.1 Power supply

	5702	5702 R	5702 RH
Mains/power connection	230 V, 50 Hz – 60 Hz 120 V, 50 Hz – 60 Hz 100 V, 50 Hz – 60 Hz	230 V, 50 Hz – 60 Hz 120 V, 50 Hz – 60 Hz 100 V, 50 Hz – 60 Hz	230 V, 50 Hz – 60 Hz 120 V, 50 Hz – 60 Hz 100 V, 50 Hz – 60 Hz
Current consumption	1.2 A (230 V) 2.3 A (120 V) 2.4 A (100 V)	1.7 A (230 V) 3.3 A (120 V) 3.5 A (100 V)	1.7 A (230 V) 3.3 A (120 V) 3.5 A (100 V)
Power consumption	Maximum 200 W	Maximum 380 W	Maximum 380 W
EMC: Noise emission (radio interference)	230 V – EN 61326-1 / EN 55011 – Class B 120 V – CFR 47 FCC Part 15 – Class B 100 V – EN 61326-1 / EN 55011 – Class B	230 V – EN 61326-1 / EN 55011 – Class B 120 V: CFR 47 FCC Part 15 – Class A 100 V – EN 61326-1 / EN 55011 – Class A	230 V – EN 61326-1 / EN 55011 – Class B 120 V: CFR 47 FCC Part 15 – Class A 100 V – EN 61326-1 / EN 55011 – Class A
EMC: Noise immunity	EN 61326-1 – basic electromagnetic environment	EN 61326-1 – basic electromagnetic environment	EN 61326-1 – basic electromagnetic environment
Overvoltage category	II	II	II
Fuses	230 V 120 V 100 V	250 V 2.5 AT HBC 250 V 5.0 AT 250 V 5.0 AT	250 V 2.5 AT HBC 250 V 5.0 AT 250 V 6.3 AT HBC
Degree of pollution	2	2	2

### 11.2 Ambient conditions

	5702	5702 R	5702 RH
Environment	For indoor use only.		
Ambient temperature	2 °C – 40 °C	10 °C – 40 °C	10 °C – 40 °C
Maximum relative humidity	75 %, non-condensing		
Atmospheric pressure	79.5 kPa – 106 kPa		

**Technical data**

Centrifuge 5702/5702 R/5702 RH  
English (EN)

**11.3 Weight/dimensions**

	<b>5702</b>	<b>5702 R</b>	<b>5702 RH</b>
Width	32.0 cm	38.1 cm	38.1 cm
Depth	39.5 cm	58.1 cm	58.1 cm
Height	24.3 cm	27.0 cm	27.0 cm
Height with open lid	52.5 cm	59.5 cm	59.5 cm
Weight without rotor	18.8 kg	35.1 kg	35.1 kg
Rotor weights:		Accessories without caps:	
A-4-38	1230 g	Round bucket	190 g
		Rectangular buckets	140 g
A-8-17	1060 g		
F-45-24-11	660 g		
F-35-30-17	1150 g	Sleeve	30 g
F-45-18-17-Cryo	930 g		

**11.4 Noise level**

The noise level was measured according to (DIN EN ISO 3745) frontally in a sound measuring room with accuracy class 1 at a distance of 1 m from the device and at lab bench height.

	<b>5702</b>	<b>5702 R</b>	<b>5702 RH</b>
Noise level using rotor A-4-38	<52 dB (A)	<46 dB (A)	<46 dB (A)

## 11.5 Application parameters

	5702	5702 R	5702 RH
Run time	30 s – 99 min, infinite ( $\infty$ ) • adjustable up to 10 min in 30 s increments, • from 10 min in 1 min increments	30 s – 99 min, infinite ( $\infty$ ) • adjustable up to 10 min in 30 s increments, • from 10 min in 1 min increments	30 s – 99 min, infinite ( $\infty$ ) • adjustable up to 10 min in 30 s increments, • from 10 min in 1 min increments
Temperature	–	-9 °C – 40 °C	-9 °C – 42 °C
Relative centrifugal force	100 × <i>g</i> – 3000 × <i>g</i> • can be set in increments of 100 × <i>g</i>	100 × <i>g</i> – 3000 × <i>g</i> • can be set in increments of 100 × <i>g</i>	100 × <i>g</i> – 3000 × <i>g</i> • can be set in increments of 100 × <i>g</i>
Rotational speed	100 rpm – 4 400 rpm • can be set in increments of 100 rpm	100 rpm – 4 400 rpm • can be set in increments of 100 rpm	100 rpm – 4 400 rpm • can be set in increments of 100 rpm
Maximum load	4x100 mL	4x100 mL	4x100 mL
Maximum kinetic energy	2 280 J	2 280 J	2 280 J
Permitted density of the material for centrifuging (at max. <i>g-force</i> [rcf] or max. rotational speed [rpm] and max. load)	1.2 g/mL	1.2 g/mL	1.2 g/mL
Inspection obligation in Germany	no	no	no

**Technical data**

Centrifuge 5702/5702 R/5702 RH  
English (EN)

**11.6 Acceleration and deceleration times**

The following table shows the approximate acceleration and deceleration times according to DIN 58970 for the rotors of the Centrifuge 5702/5702 R/5702 RH. All values given are reference values. Fluctuations may occur depending on the condition of the device and the load.

Rotor		Centrifuge 5702		Centrifuge 5702 R		Centrifuge 5702 RH	
			Soft ramp		Soft ramp		Soft ramp
A-4-38 with round buckets	Acceleration time	19 s	1:38 min	16 s	1:37 min	16 s	1:37 min
	Deceleration time	18 s	1:31 min	22 s	1:33 min	23 s	1:32 min
	Tolerance	±5 %, 5 s minimum					
A-4-38 with rectangular buckets	Acceleration time	18 s	1:38 min	16 s	1:37 min	16 s	1:37 min
	Deceleration time	19 s	1:30 min	22 s	1:33 min	22 s	1:32 min
	Tolerance	±5 %, 5 s minimum					
A-8-17	Acceleration time	14 s	1:37 min	15 s	1:37 min	15 s	1:37 min
	Deceleration time	17 s	1:34 min	19 s	1:35 min	19 s	1:33 min
	Tolerance	±5 %, 5 s minimum					
FA-45-24-11	Acceleration time	13 s	1:36 min	14 s	1:36 min	15 s	1:37 min
	Deceleration time	16 s	1:32 min	19 s	1:36 min	19 s	1:32 min
	Tolerance	±5 %, 5 s minimum					
F-35-30-17	Acceleration time	17 s	1:41 min	20 s	1:38 min	19 s	1:38 min
	Deceleration time	17 s	1:30 min	28 s	1:30 min	29 s	1:29 min
	Tolerance	±5 %, 5 s minimum					

## 11.7 Service life for accessories



### CAUTION! Danger due to material fatigue.

If the service life is exceeded, it cannot be guaranteed that the material of the rotors and the accessories will withstand the stresses during centrifugation.

- ▶ Do not use accessories that have exceeded their maximum service life.

Eppendorf states the maximum service life of the rotors and accessories both in years and in the maximum number of cycles. The decisive factor for the service life is which case occurs first, usually this is the number of years in operation.

Each centrifugation run during which the rotor is accelerated and braked is counted as a cycle independent of the speed and the duration of the centrifugation run.

All other rotors and rotor lids can be used during the entire service life of the centrifuge if the following conditions are met:

- proper use
- recommended maintenance
- undamaged condition

Accessories	Maximum service life after initial setup	
Rotor lid of polycarbonate (PC), polypropylene (PP) or polyetherimide (PEI)	–	3 years
Aerosol-tight rotor lid, without replaceable seals	50 autoclaving cycles	–
QuickLock rotor lid		3 years
Seals in the QuickLock rotor lid	50 autoclaving cycles	–
Caps of polycarbonate (PC), polypropylene (PP) or polyetherimide (PEI)	50 autoclaving cycles	3 years
Adapter	–	1 year

The date of manufacture is stamped on the rotors and buckets in the format *03/15* or *03/2015* (= March 2015). On the inside of the plastic-rotor lids and aerosol-tight caps, the date of manufacture is stamped in the form of a clock ⌚.

### Measures to ensure aerosol tightness:

- ▶ Replace the seal of QuickLock rotor lids after 50 autoclaving cycles.
- ▶ Exchange aerosol-tight rotor lids without replaceable seals after 50 autoclaving cycles.
- ▶ Replace aerosol-tight caps after 50 autoclaving cycles.

**Technical data**

Centrifuge 5702/5702 R/5702 RH  
English (EN)

## 12 Rotors, tubes and adapters





Eppendorf centrifuges may only be operated with rotors that are intended for use with the corresponding centrifuge.



- ▶ Only use rotors that are intended for use with the corresponding centrifuge.

Please note the manufacturer's information on the centrifugation resistance of the sample tubes used (maximum *g*-force).

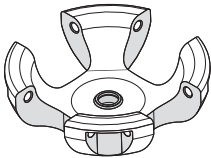
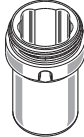



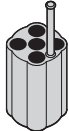
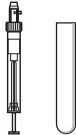
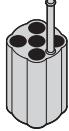

### 12.1 Rotor A-4-38

#### 12.1.1 Rotor A-4-38 with 4 round buckets

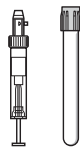
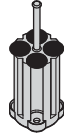
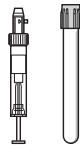

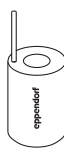
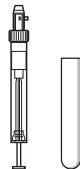
			Max. <i>g</i> -force: 3000 × <i>g</i>
			Max. speed: 4400 rpm
<b>Rotor A-4-38</b>	<b>Round bucket</b> 5702 722.006 5702 761.001	<b>Aerosol-tight cap</b> 5702 721.000	Max. load per bucket (adapter, tube and contents): 190 g

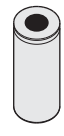
Tube	Tube Capacity Number per adapter/rotor	Adapter Order no. (international)	Bottom shape Tube diameter Max. tube length with/without aerosol-tight cap	Max. <i>g</i> -force Max. speed Radius
	Micro test tube 1.5 mL – 2 mL  4/16	 5702 745.006	round Ø 11 mm  43 mm/43 mm	2900 × <i>g</i> 4400 rpm  13.4 cm
	Micro test tube 1.1 mL – 1.4 mL  5/20	 5702 736.007	flat Ø 8.5 mm  100 mm/100 mm	2850 × <i>g</i> 4400 rpm  13.2 cm
	Micro test tube 2 mL – 7 mL  5/20	 5702 737.003 5702 741.000	flat Ø 12.5 mm  100 mm/100 mm	2850 × <i>g</i> 4400 rpm  13.2 cm

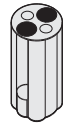

**Rotors, tubes and adapters**  
Centrifuge 5702/5702 R/5702 RH  
English (EN)

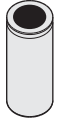

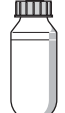
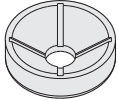



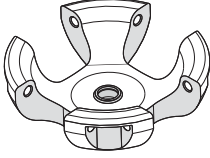

Tube	Tube Capacity Number per adapter/rotor	Adapter Order no. (international)	Bottom shape Tube diameter Max. tube length with/without aerosol-tight cap	Max. <i>g</i> -force Max. speed Radius
	Micro test tube 2.6 mL – 7 mL  4/16	 5702 719.005 5702 741.000	flat Ø 13.5 mm  100 mm/100 mm	2850 × <i>g</i> 4400 rpm  13.2 cm
	Micro test tube 4 mL – 10 mL  4/16	 5702 735.000 5702 742.007	flat Ø 16 mm  100 mm/100 mm	2850 × <i>g</i> 4400 rpm  13.2 cm
	Micro test tube 5 mL  1/4	 5702 733.008	flat Ø 17 mm  60 mm/60 mm	2943 × <i>g</i> 4400 rpm  13.6 cm
	Micro test tube 9 mL – 15 mL  4/16	 5702 724.009 5702 749.007	round Ø 17.5 mm  100 mm/100 mm	2800 × <i>g</i> 4400 rpm  13.0 cm
	Micro test tube 15 mL  1/4	 5702 732.001	conical Ø 17.2 mm  120 mm/121 mm	3000 × <i>g</i> 4400 rpm  13.7 cm
	Micro test tube 15 mL  2/8	 5702 723.002	conical Ø 17.2 mm  -/121 mm	3000 × <i>g</i> 4400 rpm  13.7 cm

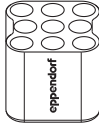



Tube	Tube Capacity Number per adapter/rotor	Adapter Order no. (international)	Bottom shape Tube diameter Max. tube length with/without aerosol-tight cap	Max. <i>g</i> -force Max. speed Radius
	Micro test tube 25 mL  1/4	  5702 717.002	round Ø 25 mm  100 mm/100 mm	2900 × <i>g</i> 4400 rpm  13.5 cm
	Micro test tube 50 mL  1/4	  5702 734.004	conical Ø 30 mm  115 mm/115 mm	2900 × <i>g</i> 4400 rpm  13.5 cm
	Micro test tube 100 mL  1/4	  5702 718.009	round Ø 38 mm  106 mm/106 mm	2900 × <i>g</i> 4400 rpm  13.5 cm

### 12.1.2 Rotor A-4-38 with 4 rectangular buckets



		Max. <i>g</i> -force:	2750 × <i>g</i>
		Max. speed:	4400 rpm
<b>Rotor A-4-38</b>	<b>Rectangular bucket</b> 5702 709.000 5702 762.008	Max. load per bucket (adapter, tube and contents):	240 g

Tube	Tube Capacity Number per adapter/rotor	Adapter Order no. (international)	Bottom shape Tube diameter Max. tube length	Max. <i>g</i> -force Max. speed Radius
	Micro test tube Cultivation vessel 5 mL  9/36	 5702 763.004	round Ø 12 mm  75 mm	2577 × <i>g</i> 4400 rpm  11.9 cm
	Micro test tube 5 mL – 7 mL  10/40	 5702 710.008	flat Ø 13 mm  100 mm	2750 × <i>g</i> 4400 rpm  12.7 cm
	Micro test tube 9 mL  8/32	 5702 711.004	flat Ø 14.5 mm  100 mm	2750 × <i>g</i> 4400 rpm  12.7 cm
	Micro test tube 15 mL  6/24	 5702 712.000	flat Ø 17.5 mm  100 mm	2750 × <i>g</i> 4400 rpm  12.7 cm
	Micro test tube 25 mL  2/8	 5702 716.006	flat Ø 25 mm  100 mm	2750 × <i>g</i> 4400 rpm  12.7 cm

Tube	Tube Capacity Number per adapter/rotor	Adapter Order no. (international)	Bottom shape Tube diameter Max. tube length	Max. <i>g</i> -force Max. speed Radius
	Micro test tube 20 mL  4/16	 5702 713.007	flat Ø 22 mm  100 mm	2750 × <i>g</i> 4400 rpm  12.7 cm

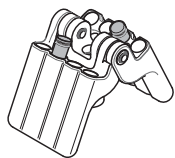

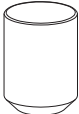



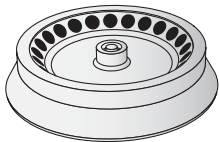

### 12.2 Rotor A-8-17

	Max. <i>g</i> -force:	2800 × <i>g</i>
	Max. rotational speed:	4400 rpm
<b>Rotor A-8-17</b>	Max. load per bucket (adapter, tube and contents):	38 g

Tube	Tube Capacity Number per adapter/rotor	Adapter Order no. (international)	Bottom shape Tube diameter Max. tube length	Max. <i>g</i> -force Max. rotational speed Radius
	Micro test tube 15 mL  1/8	 5702 702.005	Conical Ø 17.2 mm  120 mm	2 770 × <i>g</i> 4400 rpm  12.8 cm
	Micro test tube 15 mL  1/8	 5702 701.009	Round Ø 17.5 mm  120 mm	2 770 × <i>g</i> 4400 rpm  12.8 cm





### 12.3 Rotor F-45-24-11

	Max. <i>g</i> -force:	1770 × <i>g</i>
	Max. speed:	4400 rpm
<b>F-45-24-11</b>	Max. load per bucket (adapter, tube and contents):	8.70 g

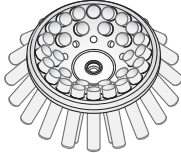
Tube	Tube Capacity Number per adapter/rotor	Adapter Order no. (international)	Bottom shape Tube diameter Max. tube length with/without rotor lid	Max. <i>g</i> -force Max. speed Radius
	Micro test tube 1.5/2 mL -/24	-	- Ø 11 mm	1770 × <i>g</i> 4400 rpm 8.2 cm
	PCR tube 0.2 mL 1/24	 5425 715.005	Conical Ø 6 mm	1 430 × <i>g</i> 4400 rpm 6.6 cm
	Micro test tube 0.4 mL 1/24	 5425 717.008	Conical Ø 6 mm	1770 × <i>g</i> 4400 rpm 8.2 cm
	Micro test tube 0.5 mL – 0.6 mL 1/24	 5425 716.001	- Ø 8 mm	1 600 × <i>g</i> 4400 rpm 7.5 cm
	Microtainers 0.6 mL 1/24	 5425 716.001	- Ø 8 mm 47 mm/64 mm	1 600 × <i>g</i> 4400 rpm 7.5 cm





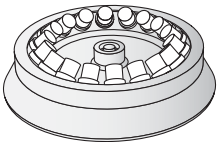

### 12.4 Rotor F-35-30-17

	Max. <i>g</i> -force:	2750 × <i>g</i>
	Max. speed:	4400 rpm
<b>Rotor F-35-30-17</b>	Max. load (adapter, tube and contents):	56 g

Tube	Tube  Capacity Number per adapter/rotor	Adapter  Order no. (international)	Bottom shape  Tube diameter Max. tube length	Max. <i>g</i> -force
				Outer ring Center ring Inner ring Max. speed Radius Outer ring Center ring Inner ring
	Micro test tube  1.5 mL – 2 mL 1/10		Ø 11 mm	- - 1450 × <i>g</i> 4400 rpm - - 6.7 cm
	Micro test tube  15 mL 1/20	  5702 707.007 5702 706.000	conical  Ø 16.2 mm	2750 × <i>g</i> 2300 × <i>g</i> - 4400 rpm 12.7 cm 10,7 cm -
	Micro test tube  15 mL 1/30	  5702 707.007 5702 708.003	round  Ø 16.2 mm	2750 × <i>g</i> 2300 × <i>g</i> - 4400 rpm 12.7 cm 10,7 cm -

## 12.5 Rotor F-45-18-17-Cryo

	Max. <i>g</i> -force:	1970 × <i>g</i>
	Max. speed:	4400 rpm
<b>F-45-18-17-Cryo</b>	Max. load (adapter, tube and contents):	8.70 g

Tube	Tube Capacity Number per adapter/rotor	Adapter Order no. (international)	Bottom shape Tube diameter Max. tube length with rotor lid	Max. <i>g</i> -force Max. speed Radius
	Vessel with screw cap 1 mL – 2 mL -/17	–	flat Ø 17 mm 50 mm	1970 × <i>g</i> 4400 rpm 9.1 cm
	Cryo tube 1 mL – 2 mL 1/17	 5702 752.002	Ø 13 mm 50 mm	1930 × <i>g</i> 4400 rpm 8.9 cm
	Tube with lid 1/17	 5702 752.002	Ø 12.2 mm 50 mm	1930 × <i>g</i> 4400 rpm 8.9 cm
	HPLC vessel 1.5 mL 1/17	 5427 708.006	Ø 16.5 mm 50 mm	1930 × <i>g</i> 4400 rpm 8.9 cm

## 13 Ordering information

### 13.1 Rotor A-4-38

#### 13.1.1 Rotor A-4-38 with round buckets

Order no. (International)	Order no. (North America)	Description
5702 720.003	022639048	<b>Rotor A-4-38</b> 8 positions, max. Ø 38 mm with 4 round buckets, 100 ml
5702 761.001	022639099	<b>Round bucket 100 mL</b> for rotor A-4-38 2 pieces
5702 722.006	022639081	4 pieces
5702 721.000	022639293	<b>Aerosol-tight cap</b> for 100 mL round buckets 2 pieces
5702 745.006	022639277	<b>Adapter for 100 mL round bucket</b> for use with standard and blood collection tubes, (number × tube volume, Ø adapter bore × max. tube length)
5702 736.007	022639285	4 × 1.5/2.0 mL tubes, set of 2
5702 737.003	022639102	5 × 1 – 1.4 mL, 8.5 mm × 100 mm, 2 pcs
5702 719.005	022639242	5 × 2 – 7 mL, 12.5 mm × 100 mm, set of 2
5702 735.000	022639269	4 × 2.6 - 7 mL, 13.5 mm × 100 mm, set of 2
5702 724.009	022639129	4 × 4 – 10 mL, 16 mm × 100 mm, set of 2
5702 732.001	022639188	4 × 9 - 15 mL, 17.5 mm × 100 mm, set of 2
5702 723.002	022639200	1 × 15 mL conical tube, 17.2 mm × 121 mm, set of 2
5702 717.002	022639145	2 × 15 mL conical tubes, 17.2 mm × 121 mm, set of 2*
5702 734.004	022639226	1 × 25 mL, 25 mm × 100 mm, set of 2
5702 718.009	022639161	1 × 50 mL conical tube, 30 mm × 115 mm, set of 2
5702 733.008	5702733008	1 × 100 mL, 38 mm × 106 mm, set of 2
		1 × 5 mL, 17 mm × 60 mm, set of 2
5702 741.000	022666941	<b>Rubber mat</b> for adapter 5702 737.003, 5702 719.005 7 mL, 20 pieces
5702 742.007	022666967	<b>Rubber mat</b> for adapter 5702 735.000 10 mL, 20 pieces

\* Cannot be used with aerosol-tight caps.

**Ordering information**Centrifuge 5702/5702 R/5702 RH  
English (EN)**13.1.2 Rotor A-4-38 with rectangular buckets**

Order no. (International)	Order no. (North America)	Description
5702 740.004	022639064	<b>Rotor A-4-38</b> 8 positions, max. Ø 38 mm without buckets
5702 762.008 5702 709.000	022639315 022639307	<b>Rectangular bucket 90 mL</b> for rotor A-4-38 2 pieces 4 pieces
5702 710.008 5702 711.004 5702 712.000 5702 713.007 5702 716.006 5702 763.004	022639323 022639340 022639366 022639382 022639391 5702763004	<b>Adapter for 90 mL rectangular bucket</b> for use with standard tubes, (number × tube volume, Ø adapter bore × max. tube length) 10 × 5 – 7 mL, 13 mm × 100 mm, set of 2 8 × 9 mL, 14.5 mm × 100 mm, set of 2 6 × 15 mL, 17.5 mm × 100 mm, set of 2 4 × 20 mL, 22 mm × 100 mm, set of 2 2 × 25 mL, 25 mm × 100 mm, set of 2 9 × 5 mL, 12 mm × 100 mm, set of 2

**13.2 Rotor A-8-17**

Order no. (International)	Order no. (North America)	Description
5702 700.002	022639501	<b>Rotor A-8-17</b> 8 Plätze, max. Ø 17 mm for 15 mL vessels
5702 702.005	022639528	<b>Adapter</b> for rotor A-8-17 for conical tubes 15 mL, 8 pieces
5702 701.009	022639510	<b>Rubber mat</b> for rotor A-8-17 15 mL round-bottom tubes, 8 pieces



### 13.3 Rotor F-45-24-11

Order no. (International)	Order no. (North America)	Description
5702 746.002	022639471	<b>Rotor F-45-24-11</b> 45° angle, 24 places, max. Ø 11 mm without lid
5425 715.005	022636260	<b>Adapter</b> used in FA-45-48-11, F-45-48-11, FA-45-30-11, F-45-30-11, F-45-24-11, F-45-70-11, FA-45-24-11, FA-45-24-11-Special, FA-45-24-11-HS and FA-45-24-11-Kit for 1 PCR tube (0.2 mL, max. Ø 6 mm), set of 6
5425 717.008	022636243	<b>Adapter</b> used in FA-45-48-11, F-45-48-11, F-45-12-11, FA-45-18-11, FA-45-30-11, F-45-30-11, F-45-24-11, F-45-70-11, FA-45-24-11-HS, FA-45-24-11-Kit and S-24-11-AT for 1 micro test tube (0.4 mL, max. Ø 6 mm), set of 6
5425 716.001	022636227	<b>Adapter</b> used in FA-45-48-11, F-45-48-11, FA-45-30-11, F-45-30-11, F-45-48-11, F-45-70-11, FA-45-24-11, FA-45-24-11-Special, FA-45-24-11-HS and FA-45-24-11-Kit for 1 sample tube (0.5 mL, max. Ø 6 mm) or 1 Microtainer (0.6 mL, max. Ø 8 mm), set of 6

### 13.4 Rotor F-35-30-17

Order no. (International)	Order no. (North America)	Description
5702 704.008	022639404	<b>Rotor F-35-30-17</b> 35° angle, 30 places, max. Ø 17 mm incl. 30 steel sleeves for 15 mL vessels, 20 Adapters for conical tubes and 30 rubber mats
5702 705.004	022639421	incl. 10 steel sleeves for 15 ml vessels, 10 Adapters for conical tubes and 10 rubber mats
5702 707.007	022639439	<b>Steel sleeve</b> for rotor F-35-30-17 15 mL, 10 pieces
5702 706.000	022639447	<b>Adapter</b> used in F-35-30-17 for conical tubes 15 mL, 10 pieces
5702 708.003	022639455	<b>Rubber mat</b> for rotor F-35-30-17 15 mL round-bottom tubes, 10 pieces

**Ordering information**

Centrifuge 5702/5702 R/5702 RH  
English (EN)

**13.5 Rotor F-45-18-17-Cryo**

Order no. (International)	Order no. (North America)	Description
5702 747.009	022639480	<b>Rotor F-45-18-17-Cryo</b> angle 45°, 18 places, max. Ø 17 mm, max. length 50 mm for cryo tubes and sealable centrifugation tubes, without rotor lid, without adapter
5702 752.002	022639498	<b>Adapter</b> used in F-45-18-17-Cryo for cryo tubes (max. Ø 13 mm) and sealable centrifuge tubes (max. Ø 12.2 mm), max. length 50 mm, set of 6 for 1.5 mL HPLC vials, 18 pieces
5427 708.006	5427708006	

**13.6 Fuses**

Order no. (International)	Order no. (North America)	Description
5425 351.003	022668188	<b>Fuse</b> 2.5 A T (230 V), set of 2 5 A T (100V/120 V), UL, set of 2 6.3 AT (100 V), 2 pieces
5425 353.006	022668226	
5703 851.136		

# Declaration of Conformity

The product named below fulfills the requirements of directives and standards listed. In the case of unauthorized modifications to the product or an unintended use this declaration becomes invalid. This declaration of conformity is issued under the sole responsibility of the manufacturer.

**Product name:**

Centrifuge 5702, Centrifuge 5702 R, Centrifuge 5702 RH  
including components

**Product type:**

Centrifuge

**Relevant directives / standards:**

2006/42/EC: DIN EN ISO 12100  
2014/35/EU: EN 61010-1, EN 61010-2-020, EN 61010-2-010 (only 5702 RH)  
UL 61010-1, CAN/CSA C22.2 No. 61010-1, IEC 61010-2-020  
2014/30/EU: EN 61326-1, EN 55011  
CFR 47 FCC part 15 class A  
2014/68/EU: EN 378-1, EN 378-2 (only 5702 R, 5702 RH)  
2011/65/EU: EN 50581

Person authorized to compile  
the technical file acc. to 2006/42EC: Dr. Reza Hashemi  
Executive Director Portfolio Management Centrifugation  
Eppendorf AG

Hamburg, August 25, 2017



Dr. Wilhelm Plüster  
Management Board



Dr. Claudia Hofmann  
Portfolio Management

Your local distributor: [www.eppendorf.com/contact](http://www.eppendorf.com/contact)  
Eppendorf AG · Barkhausenweg 1 · 22339 Hamburg · Germany  
[eppendorf@eppendorf.com](mailto:eppendorf@eppendorf.com)

Eppendorf® and the Eppendorf Brand Design are registered trademarks of Eppendorf AG, Germany.  
All rights reserved, incl. graphics and pictures. Copyright ©2017 by Eppendorf AG.

[www.eppendorf.com](http://www.eppendorf.com)

ISO  
9001  
Certified

ISO  
13485  
Certified

ISO  
14001  
Certified

5703 900.315-00

# CERTIFICATE OF COMPLIANCE

**Certificate Number** 2018-6-22-E215059  
**Report Reference** E215059-D1005-1/A0/C0-UL  
**Issue Date** 2018-6-22

**Issued to:** EPPENDORF AG  
**Applicant Company:** BARKHAUSENWEG 1  
22339 HAMBURG  
GERMANY

**Listed Company:** Same as applicant

**This is to certify that representative samples of** Centrifuge  
5702

Have been investigated by UL in accordance with the Standard(s) indicated on this Certificate.

**Standard(s) for Safety:** UL 61010-1, 3rd Edition, May 11, 2012, Revised April 29 2016, CAN/CSA-C22.2 No. 61010-1-12, 3rd Edition, Revision dated April 29 2016

**Additional Standards:** IEC 61010 2-020: 2016 (Third Edition) for use in combination with IEC 61010 1:2010 (Third Edition)

**Additional Information:** See the UL Online Certifications Directory at [www.ul.com/database](http://www.ul.com/database) for additional information.

Only those products bearing the UL Certification Mark should be considered as being covered by UL's Certification and Follow-Up Service.

Look for the UL Certification Mark on the product.

This is to certify that representative samples of the product as specified on this certificate were tested according to the current UL requirements.

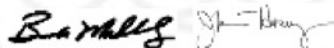

Bruce Mahrenholz, Assistant Chief Engineer, Global Inspection and Field Services, UL LLC  
Joseph Hosey, General Manager, Director of Sales – Canada, UNDERWRITERS LABORATORIES OF CANADA INC.

Any information and documentation involving UL Mark services are provided on behalf of UL LLC (UL) or any authorized licensee of UL. For questions, please contact a local UL Customer Service Representative [www.ul.com/contactus](http://www.ul.com/contactus)



# CERTIFICATE OF COMPLIANCE

**Certificate Number** 20120914- E215059  
**Report Reference** E215059-20120914  
**Issue Date** 2012-SEPTEMBER-14

**Issued to:** EPPENDORF ZENTRIFUGEN GMBH  
RIESAEER STR 198  
04319 LEIPZIG GERMANY

**This is to certify that  
representative samples of**

LABORATORY-USE ELECTRICAL EQUIPMENT  
Laboratory Centrifuge 5702R, 5703, 5702RH, 5704

Have been investigated by UL in accordance with the  
Standard(s) indicated on this Certificate.

**Standard(s) for Safety:**

UL 61010-1 (Electrical Equipment for Measurement,  
Control, and Laboratory Use; Part 1: General  
Requirements)  
CAN/CSA-C22.2 No. 61010-1 (Electrical Equipment for  
Measurement, Control, and Laboratory Use; Part 1: General  
Requirements)

**Additional Information:**

See the UL Online Certifications Directory at  
[www.ul.com/database](http://www.ul.com/database) for additional information

Only those products bearing the UL Listing Mark for the US and Canada should be considered as being covered by UL's Listing and Follow-Up Service meeting the appropriate requirements for US and Canada.

The UL Listing Mark for the US and Canada generally includes: the UL in a circle symbol with "C" and "US" identifiers:  the word "LISTED"; a control number (may be alphanumeric) assigned by UL; and the product category name (product identifier) as indicated in the appropriate UL Directory.

Look for the UL Listing Mark on the product.



William R. Carney, Director, North American Certification Programs

UL LLC

Any information and documentation involving UL Mark services are provided on behalf of UL LLC (UL) or any authorized licensee of UL. For questions, please contact a local UL Customer Service Representative at [www.ul.com/contactus](http://www.ul.com/contactus)



© CAMR The contents of this report may not be abstracted, published or used for advertising without permission.

## Containment Testing of the Sealed Buckets For The A-4-38 Rotor in the Eppendorf 5702 Bench Top Centrifuge

**Report 769/02**

**Commercial in Confidence**

<b>CAMR Ref.</b>	Project No. 769/02
<b>Customer Ref.</b>	620-804158
<b>Report Prepared For</b>	Ms. Sylke Grun
<b>Operator</b>	Ms Carolyn Budge
<b>Issue Date</b>	27th August 2002
<b>Number of Copies</b>	1
<b>Distribution</b>	Ms. S Grun, Mr. A. Bennett, Central Records (Dr. P. Hammond)

**Report Checked By**



**Name** Ms. Sara Speight  
**Title** Research Scientist

**Authorised And Written By**



**Name** Mr Allan Bennett  
**Title** Head of Biosafety Investigation Unit



# Evaluate Your Manual

Give us your feedback.

[www.eppendorf.com/manualfeedback](http://www.eppendorf.com/manualfeedback)

**Your local distributor: [www.eppendorf.com/contact](http://www.eppendorf.com/contact)**

Eppendorf AG · Barkhausenweg 1 · 22339 Hamburg · Germany  
[eppendorf@eppendorf.com](mailto:eppendorf@eppendorf.com) · [www.eppendorf.com](http://www.eppendorf.com)