



DOC022.52.80041

2100Q and 2100Q*is*

12/2017, Edition 4

User Manual

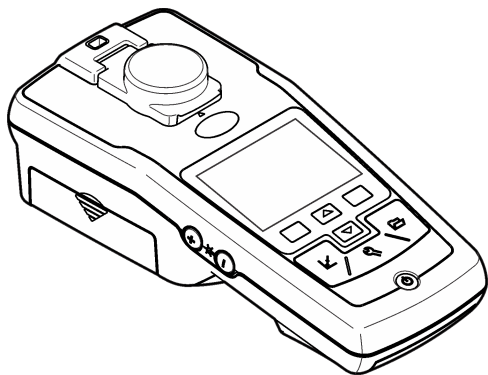

Specifications	3
General information	3
Safety information	4
Use of hazard information	4
Precautionary labels	4
Certification	4
Product overview	5
Product components	5
Installation	6
Install the battery	6
User interface and navigation	7
User interface	7
Display description	8
Navigation	8
Startup	8
Turn the meter on and off	8
Change the language	8
Change the date and time	9
Standard operation	9
Use a sample ID	9
Use an operator ID	9
Calibrate the turbidimeter with StablCal Standards	9
Turbidity measurement	10
Measurement notes	10
Turbidity measurement procedure	11
Data management	11
About stored data	11
View data log	11
Delete data log	12

Table of Contents

Send stored data	12
Advanced operation	12
Display contrast	12
Power management	12
Set the sound options	13
Security options	13
Turn security options on	13
View meter information	13
Calibration	13
Calibration options	13
Calibration standard overview	14
StablCal RapidCal calibration	15
Verification options	16
Calibration verification (Verify Cal)	16
Reading modes	17
Apply silicone oil to a sample cell	17
Indexing a single cell	17
Maintenance	19
Clean the meter	19
Store the sample cells	19
Replace the battery	19
Replace the lamp	19
Troubleshooting	22
Replacement parts and accessories	23
Replacement parts	23
Accessories	23
Index	25

Specifications

Specifications are subject to change without notice.

Specification	Details
Measurement method	Ratio turbidimetric determination using a primary nephelometric light scatter signal (90°) to the transmitted light scatter signal.
Regulatory	2100Q: Meets EPA Method 180.1
Lamp source	2100Q: Tungsten filament lamp 2100Qs: Light-emitting diode (LED)
Range	0–1000 NTU (FNU)
Accuracy	±2% of reading plus stray light from 0–1000 NTU (FNU)
Repeatability	±1% of reading or 0.01 NTU (FNU), whichever is greater
Resolution	0.01 NTU on lowest range
Stray light	≤ 0.02 NTU (FNU)
Signal averaging	Selectable on or off
Detector	Silicon Photodiode
Reading modes	Normal (Push to Read), Signal Averaging or Rapidly Settling Turbidity
Calibration options	Single step RapidCal for Low-Level Regulatory Reporting from 0–40 NTU (FNU) Full range calibration from 0–1000 NTU (FNU) Calibration to degrees of turbidity
Calibration logger	Records the last 25 successful calibrations
Verification logger	Logs the last 250 successful verifications
Data logger	500 records

Specification	Details
Power requirement	AC 100–240 V , 50/60 Hz (with power or USB/power module) 4 AA alkaline batteries Rechargeable NiMH (for use with USB/power module)
Operating conditions	Temperature: 0 to 50 °C (32 to 122 °F) Relative Humidity: 0–90% at 30 °C, 0–80% at 40 °C, 0–70% at 50 °C, noncondensing
Storage conditions	–40 to 60 °C (–40 to 140 °F), instrument only
Interface	Optional USB
Sample required	15 mL (0.5 oz.)
Sample cells	Round cells 60 x 25 mm (2.36 x 1 in.) borosilicate glass with screw caps
Dimensions	22.9 x 10.7 x 7.7 cm (9.0 x 4.2 x 3.0 in.)
Weight	530 g (1.17 lb) without batteries 620 g (1.37 lb) with four AA alkaline batteries
Meter enclosure rating	IP67 (closed lid, battery and module compartment excluded)
Protection class	Power supply: Class II
Certification	CE certified
Warranty	1 year (EU: 2 years)

General information

In no event will the manufacturer be liable for direct, indirect, special, incidental or consequential damages resulting from any defect or omission in this manual. The manufacturer reserves the right to make changes in this manual and the products it describes at any time, without notice or obligation. Revised editions are found on the manufacturer's website.

Safety information

NOTICE

The manufacturer is not responsible for any damages due to misapplication or misuse of this product including, without limitation, direct, incidental and consequential damages, and disclaims such damages to the full extent permitted under applicable law. The user is solely responsible to identify critical application risks and install appropriate mechanisms to protect processes during a possible equipment malfunction.

Please read this entire manual before unpacking, setting up or operating this equipment. Pay attention to all danger and caution statements. Failure to do so could result in serious injury to the operator or damage to the equipment.

Make sure that the protection provided by this equipment is not impaired. Do not use or install this equipment in any manner other than that specified in this manual.

Use of hazard information

⚠ DANGER

Indicates a potentially or imminently hazardous situation which, if not avoided, will result in death or serious injury.

⚠ WARNING

Indicates a potentially or imminently hazardous situation which, if not avoided, could result in death or serious injury.

⚠ CAUTION



Indicates a potentially hazardous situation that may result in minor or moderate injury.

NOTICE

Indicates a situation which, if not avoided, may cause damage to the instrument. Information that requires special emphasis.

Precautionary labels

Read all labels and tags attached to the instrument. Personal injury or damage to the instrument could occur if not observed. A symbol on the instrument is referenced in the manual with a precautionary statement.

	This is the safety alert symbol. Obey all safety messages that follow this symbol to avoid potential injury. If on the instrument, refer to the instruction manual for operation or safety information.
	This symbol indicates that a risk of electrical shock and/or electrocution exists.
	Electrical equipment marked with this symbol may not be disposed of in European public disposal systems after 12 August of 2005. In conformity with European local and national regulations (EU Directive 2002/96/EC), European electrical equipment users must now return old or end-of-life equipment to the Producer for disposal at no charge to the user. <i>Note: For return for recycling, please contact the equipment producer or supplier for instructions on how to return end-of-life equipment, producer-supplied electrical accessories, and all auxiliary items for proper disposal.</i>

Certification

Canadian Radio Interference-Causing Equipment Regulation, IECS-003, Class A:

Supporting test records reside with the manufacturer.

This Class A digital apparatus meets all requirements of the Canadian Interference-Causing Equipment Regulations.

Cet appareil numérique de classe A répond à toutes les exigences de la réglementation canadienne sur les équipements provoquant des interférences.

FCC Part 15, Class "A" Limits

Supporting test records reside with the manufacturer. The device complies with Part 15 of the FCC Rules. Operation is subject to the following conditions:

1. The equipment may not cause harmful interference.
2. The equipment must accept any interference received, including interference that may cause undesired operation.

Changes or modifications to this equipment not expressly approved by the party responsible for compliance could void the user's authority to operate the equipment. This equipment has been tested and found to comply with the limits for a Class A digital device, pursuant to Part 15 of the FCC rules. These limits are designed to provide reasonable protection against harmful interference when the equipment is operated in a commercial environment. This equipment generates, uses and can radiate radio frequency energy and, if not installed and used in accordance with the instruction manual, may cause harmful interference to radio communications. Operation of this equipment in a residential area is likely to cause harmful interference, in which case the user will be required to correct the interference at their expense. The following techniques can be used to reduce interference problems:

1. Disconnect the equipment from its power source to verify that it is or is not the source of the interference.
2. If the equipment is connected to the same outlet as the device experiencing interference, connect the equipment to a different outlet.
3. Move the equipment away from the device receiving the interference.
4. Reposition the receiving antenna for the device receiving the interference.
5. Try combinations of the above.

Product overview

The 2100Q and 2100Q/s portable turbidimeters measure turbidity from 0 to 1000 NTU (FNU). Primarily for field use, the portable meter operates on four AA batteries. Data can be stored and transferred to a printer, computer or USB storage device.

Figure 1 Product overview

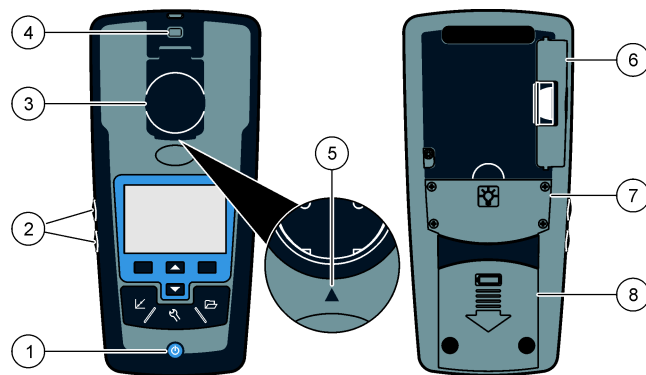

1 Power on or off	5 Alignment arrow
2 Backlight keys (+ and -)	6 Module
3 Sample cell holder with lid	7 Lamp compartment
4 Attachment for lanyard	8 Battery compartment

Product components

Refer to [Figure 2](#) to make sure that all components have been received. If any of these items are missing or damaged, contact the manufacturer or a sales representative immediately.

Figure 2 2100Q and 2100Qis components

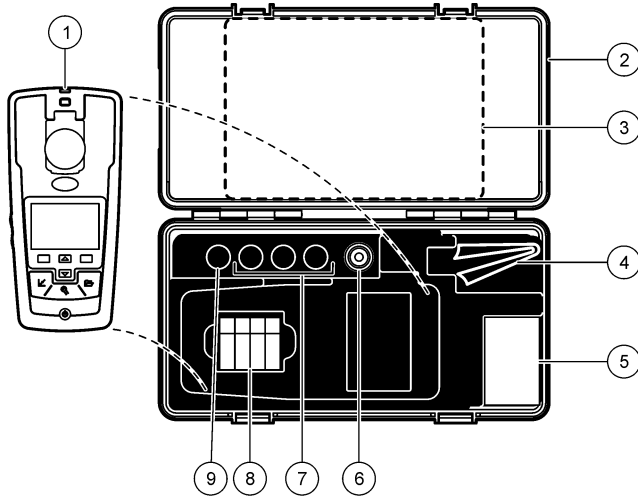

1 2100Q or 2100Qis turbidimeter	6 Silicone oil
2 Carrying case	7 20, 100 and 800 NTU StablCal calibration standards
3 User manual and Quick reference guide	8 AA alkaline batteries (pk/4)
4 Oiling cloth	9 StablCal 10 NTU verification standard
5 1" sample cell (10 mL) with cap (pk/6)	

Installation

⚠ CAUTION



Multiple hazards. Only qualified personnel must conduct the tasks described in this section of the document.

Install the battery

⚠ WARNING



Explosion hazard. An expired battery can cause hydrogen gas buildup inside the instrument. Replace the battery before it expires. Do not store the instrument for long periods with a battery installed.

⚠ WARNING

Potential fire hazard. Use only alkaline or nickel metal hydride batteries (NiMH) in the meter. Other battery types or incorrect installation can cause a fire. Never mix battery types in the meter.

NOTICE

The battery compartment is not waterproof. If the battery compartment becomes wet, remove and dry the batteries and dry the interior of the compartment. Check the battery contacts for corrosion and clean them if necessary.

NOTICE

When using nickel metal hydride (NiMH) batteries, the battery icon will not indicate a full charge after freshly charged batteries have been inserted (NiMH batteries are 1.2 V versus 1.5 V for alkaline batteries). Even though the icon does not indicate complete charge, 2300 mAh NiMH batteries will achieve 90% of instrument operation lifetime (before recharge) versus new alkaline batteries.

NOTICE

To avoid potential damage to the meter from battery leakage, remove the meter batteries prior to extended periods of non-use.

The meter can be powered with AA alkaline or rechargeable NiMH batteries. To conserve battery life, the meter will power off after 10 minutes of inactivity, the backlight powers off after 30 seconds. This time can be changed in the Power Management menu.

Note: Rechargeable batteries will only be recharged with the USB/power module. Refer to the module documentation for further information.

For battery installation refer to [Figure 3](#).

1. Remove the battery cover.
2. Install 4 AA alkaline or 4 AA nickel metal hydride (NiMH) batteries. Make sure that the batteries are installed in the correct orientation.
3. Replace the battery cover.

Figure 3 Battery installation

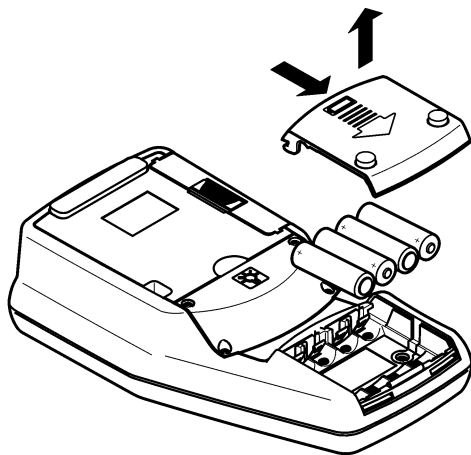

User interface and navigation

User interface

Figure 4 Keypad description

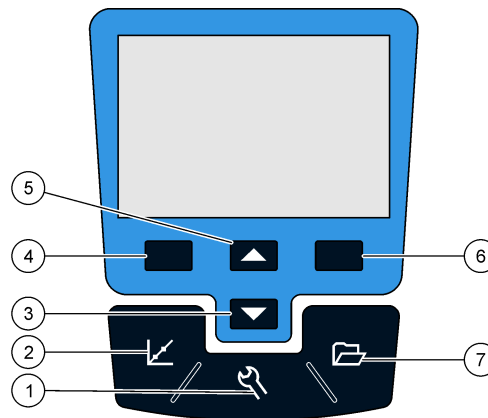

1 SETTINGS key: select menu options for setting up the meter	5 UP key: scroll through menus, enter numbers and letters
2 CALIBRATION key: shows calibration screen, start calibration, select cal options	6 RIGHT key (contextual): read turbidity sample, selects or confirms options, opens/jumps to sub-menus
3 DOWN key: scroll through menus, enter numbers and letters	7 DATA MANAGEMENT key: view, delete or transfer stored data
4 LEFT key (contextual): access for calibration verification, cancels or exits the current menu screen to the previous menu screen	

Display description

The measurement screen shows the turbidity, unit, calibration status, date and time, operator ID (if setup) and sample ID (if setup). Refer to [Figure 5](#).

Figure 5 Single screen display

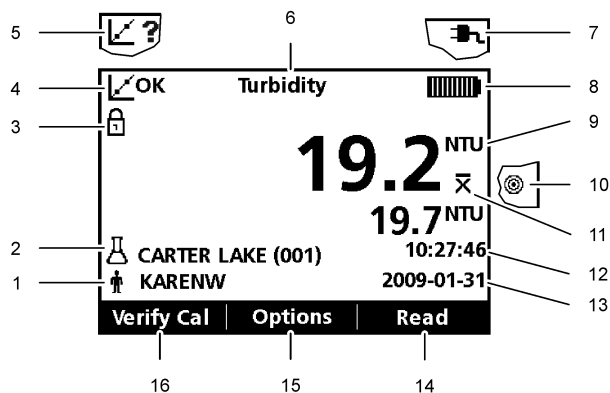

1 Operator identification	9 NTU (Nephelometric Turbidity Unit) or FNU (Formazin Turbidity Unit)
2 Sample identification	10 Reading mode: Rapidly Settling Turbidity (Target icon)
3 Stability or display lock indicator	11 Reading mode: Signal Average (X-bar icon)
4 Calibration status indicator (Calibration OK=pass)	12 Time
5 Calibration status indicator (Calibration ?=fail)	13 Date
6 Parameter title	14 Read (contextual: OK, Select)
7 AC power icon	15 Options (contextual)
8 Battery icon	16 Verification calibration

Navigation

The meter contains a Settings menu, Reading Options menu, Calibration Options menu and Calibration Verification Options menu to change various options. Use the **UP** and **DOWN** keys to highlight different options. Push the **RIGHT** key to select an option. There are two ways to change options:

1. Select an option from a list: Use the **UP** and **DOWN** keys to select an option. If check boxes are shown, more than one option can be selected. Push the **LEFT** key under Select.

*Note: To deselect check boxes, push the **LEFT** key under Deselect.*
2. Enter an option value using the arrow keys: Push the **UP** and **DOWN** keys to enter or change a value.
3. Push the **RIGHT** key to advance to the next space.
4. Push the **RIGHT** key under **OK** to accept the value.

Startup

Turn the meter on and off

 Push the **ON/OFF** key to turn on or turn off the meter. If the meter does not turn on, make sure that the batteries, or the module, are properly installed or that the AC power supply is properly connected to an electrical outlet.

Note: The Auto-Shutoff option can also be used to turn off the meter. Refer to [Power management](#) on page 12.

Change the language

There are three options to set the language:

- The display language is selected when the meter is powered on for the first time.
- The display language is selected when the power key is pushed and held.
- The language can be changed from the Settings menu.

1. Select a language from the list. Confirm with **OK**.
2. Push **Done** when the update is complete.

Change the date and time

The date and time can be changed from the Date & Time menu.

1. Push the **SETTINGS** key and select Date & Time.
2. Update the time and date information:

Option	Description
Format	Select one of the formats for the date and time: yyyy-mm-dd 24h yyyy-mm-dd 12h dd-mm-yyyy 24h dd-mm-yyyy 12h mm/dd/yyyy 24h mm/dd/yyyy 12h
Date	Enter the current date
Time	Enter the current time

The current date and time will be shown on the display.

After the date and time setup, the meter is ready to take a reading.

Standard operation

Use a sample ID

The sample ID tag is used to associate readings with a particular sample location. If assigned, stored data will include this ID.

1. Select **Sample ID** in the Settings menu.

2. Select, create or delete a sample ID:

Option	Description
Current ID	Select an ID from a list. The current ID will be associated with sample data until a different ID is selected.
Create a New Sample ID	Enter a name for a new sample ID.
Delete Sample ID	Delete an existing sample ID.

Use an operator ID

The operator ID tag associates readings with an individual operator. All stored data will include this ID.

1. Select **Operator ID** in the Settings menu.
2. Select, create or delete an operator ID:

Option	Description
Current ID	Select an ID from a list. The current ID will be associated with sample data until a different ID is selected.
Create a New Operator ID	Enter a name for a new operator ID (maximum 10 names can be entered).
Delete Operator ID	Delete an existing operator ID.

Calibrate the turbidimeter with StabCal Standards

Note: For best accuracy use the same sample cell or four matched sample cells for all readings during calibration. Insert the sample cell in the instrument cell

compartment so the diamond or orientation mark aligns with the raised orientation mark in front of the cell compartment.

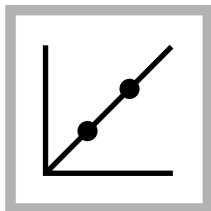

1. Push the **CALIBRATION** key to enter the Calibration mode. Follow the instructions on the display.

Note: Gently invert each standard before inserting the standard.

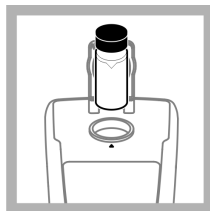

2. Insert the 20 NTU StablCal Standard and close the lid.
Note: The standard to be inserted is bordered.

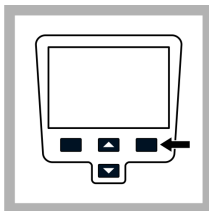

3. Push **Read**. The display shows Stabilizing and then shows the result.

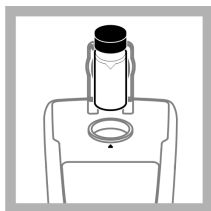

4. Repeat Step 2 and 3 with the 100 NTU and 800 NTU StablCal Standard.

Note: Push **Done** to complete a 2 point calibration.

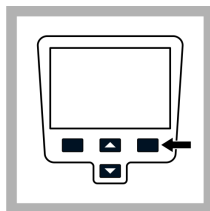

5. Push **Done** to review the calibration details.

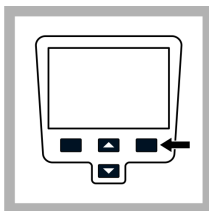

6. Push **Store** to save the results. After a calibration is complete, the meter automatically goes into the Verify Cal mode. Refer to [Calibration verification \(Verify Cal\)](#) on page 16.

Turbidity measurement

⚠ WARNING

Potential explosion and fire hazard. This turbidimeter is designed for water based samples. Do not measure solvent or combustible based samples.

Readings can be taken with the Normal reading mode, Signal Average mode or in the Rapidly Settling Turbidity mode. Refer to [Reading modes](#) on page 17 for more information. For accurate turbidity readings use clean sample cells and remove air bubbles (degassing).

Measurement notes

Proper measurement techniques are important in minimizing the effects of instrument variation, stray light and air bubbles. Use the following measurement notes for proper measurements.

Instrument

- Make sure that the meter is placed on a level, stationary surface during the measurement.
Note: Do not hold the meter in the hand during measurement.
- Always close the sample compartment lid during measurement, calibration and storage.
- Remove sample cell and batteries from the instrument if the instrument is stored for an extended time period (more than a month).
- Keep the sample compartment lid closed to prevent the entry of dust and dirt.

Sample cells

- Always cap the sample cell to prevent spillage of the sample into the instrument.
- Always use clean sample cells in good condition. Dirty, scratched or damaged cells can cause inaccurate readings.
- Make sure that cold samples do not “fog” the sample cell.
- Store sample cells filled with distilled or deionized water and cap tightly.

Measurement

- Measure samples immediately to prevent temperature changes and settling. Before a measurement is taken, always make sure that the sample is homogeneous throughout.
- Avoid sample dilution when possible.
- Avoid operation in direct sunlight.

Turbidity measurement procedure

Note: Before a measurement is taken, always make sure that the sample is homogeneous throughout.

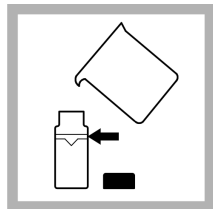

1. Collect a representative sample in a clean container. Fill a sample cell to the line (about 15 mL). Take care to handle the sample cell by the top. Cap the cell.



2. Wipe the cell with a soft, lint-free cloth to remove water spots and fingerprints.

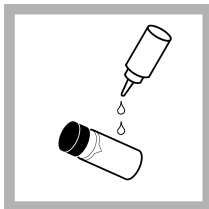

3. Apply a thin film of silicone oil. Wipe with a soft cloth to obtain an even film over the entire surface ([Apply silicone oil to a sample cell](#) on page 17).

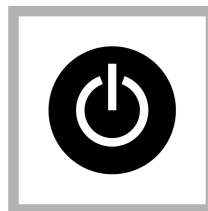

4. Push the **Power** key to turn the meter on. Place the instrument on a flat, sturdy surface.

Note: Do not hold the instrument while making measurements.

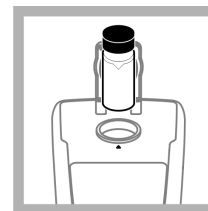

5. Gently invert and then insert the sample cell in the instrument cell compartment so the diamond or orientation mark aligns with the raised orientation mark in front of the cell compartment. Close the lid.

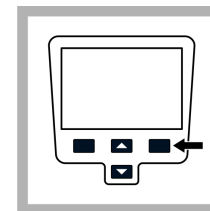

6. Push **Read**. The display shows **Stabilizing** then the turbidity in NTU (FNU). The result is shown and stored automatically. Additional information is available on the manufacturer's website.

Data management

About stored data

The following types of data are stored in the data log:

- Reading Log: stores automatically each time a sample reading is taken (500 records).
- Calibration Log: stores only when **Store** is selected at the end of a calibration (25 records).
- Verify Cal Log: stores only after **Done** is selected at the end of a verification calibration (250 records).

When the data log becomes full, the oldest data point is deleted when more data is added to the log.

View data log

The data log contains Reading Log, Calibration Log and Verify Cal log. All logs can be sorted by date.

1. Push the **DATA MANAGEMENT** key.
2. Select View Data Log to view the stored data.
3. Push **Select** to view additional information.

Option	Description
Reading Log	Reading Log—shows the date, time and reading mode and associated calibration data.
Calibration Log	Calibration Log—shows the date and time of calibration data and additional information about the calibration.
Verify Cal Log	Verify Cal Log—shows the calibration verification date and time and additional information about the verification.
All Logs by Date	The most recent data and additional information is shown. The icons show whether the data is from a reading, calibration or calibration verification and identifies the reading mode, if applicable.

Delete data log

There are two possibilities to delete stored readings in the Data Management menu:

1. Push the **DATA MANAGEMENT** key and select Delete Data Log.

Option	Description
Delete Last Reading	Only the last reading stored can be deleted until a new reading is taken and stored.
Delete All Logs	The entire Reading Log can be deleted at once.

Send stored data

Data can be stored and transferred to a printer, computer or USB storage device. The data will be formatted as an XML file. Install the USB/power module to the meter and to AC power. Refer to the module documentation for more information.

Advanced operation

Display contrast

1. Push the **SETTINGS** key and select Display Contrast.
2. Use the **UP** and **DOWN** key to adjust the contrast of the display and push OK.

Power management

Use power management to change the backlight option and the battery saving auto-shutoff option.

Note: *Power management is not active when the meter is connected to AC power.*

1. Push the **SETTINGS** key and select Power Management.
2. Select which display option to change.

Option	Description
Backlight	The display is illuminated. To maximize battery life, select a time period after which the backlight will automatically power off if no key is pushed: 10 s, 20 s, 30 s, 1 min, 2 min, 5 min Note: <i>The Backlight keys (Figure 1 on page 5) will turn the backlight on and off.</i>
Auto-Shutoff	To maximize battery life, set a time period after which the meter will automatically power off if no key is pushed: 1 min, 2 min, 5 min, 10 min, 30 min, 1 h

Set the sound options

The meter can make an audible sound when a key is pushed, when a reading is complete or when the calibration reminder is due.

1. Push **SETTINGS** and select Sounds.
2. Select which events will produce an audible sound. Multiple items can be selected.

Option	Description
Key Press	The meter will make an audible sound whenever a key is pushed.
Reading complete	The meter will make an audible sound whenever a reading is completed.
Reminders	The meter will make an audible sound when a calibration is due.

Security options

The Security Options menu is used to protect the meter setup.

The Setup Date and Time, Delete Data Log, Restoring Factory Defaults and Restore Factory Cal screens are not accessible without a password.

Store the password in a safe and accessible place. If the specified password is forgotten and Security Options is turned on, the operator is locked out of the restricted menus. Contact technical support if the password is lost.

Turn security options on

The security options and the set password options are used together to prevent access to restricted menus.

1. Push the **SETTINGS** key and select Security Options.
2. Select Edit Password and use the **UP** and **DOWN** keys to set a password.
3. Select Security On to enable the password setting. The requirement for the password entry is controlled by setting Security Options on or off.

Note: Set the Security to Off to disable the password setting.

4. Push the **ON/OFF** key to turn off and on the meter to activate the password settings.

View meter information

The instrument information menu shows specific information such as the meter name, model number, software version, serial number and available Operator and Sample IDs. 10 Operator IDs and 100 Sample IDs are available.

1. Push the **SETTINGS** key and select Meter Information.

Calibration

The portable turbidimeter is calibrated with Formazin Primary Standards at the factory. The meter should be calibrated upon receipt for best results. The manufacturer recommends calibration with a primary standard such as StablCal Stabilized Standards or with formazin standards every three months.

Note: Set **Cal Reminder Repeat** in the *Calibration Options* menu for periodical calibration. Verify the calibration once a week.

Calibration options

The calibration options contain Calibration History, Calibration Curves, Cal Reminder Repeat and Restore Factory Calibration.

1. Push the **CALIBRATION** key and then the **UP** and **DOWN** key.

Option	Description
Calibration History	The calibration history shows a list of the times when the meter was calibrated. Select a date and time to view a summary of the calibration data.

Option	Description
Cal.Curve	Select one of the calibration curves for calibration: StablCal RapidCal (0–40 NTU) StablCal (0–1000 NTU) Formazin RapidCal (0–40 NTU) Formazin (0–1000 NTU) Degrees (0–100 mg/L) SDVB (0–1000 NTU) Custom (0–1000 NTU)
Cal Reminder Repeat	The meter will make an audible sound when calibration is due. Select one of the following options for time interval and push OK: Off, 1 d, 7 d, 30 d, 60 d, 90 d
Restore Factory Calibration	All user calibrations will be deleted. The original factory calibration is restored.

Table 1 Calibration overview (continued)

Type of calibration	Required standards			
SDVB (0–1000 NTU)	Typically deionized or distilled water ¹	20 NTU	100 NTU	800 NTU
Custom (0–1000 NTU)	Typically deionized or distilled water ¹	Select values		

Calibration standard overview

Refer to [Table 1](#) for the calibration standard overview.

Table 1 Calibration overview

Type of calibration	Required standards			
StablCal RapidCal (0–40 NTU)	–	20 NTU	–	–
StablCal (0–1000 NTU)	–	20 NTU	100 NTU	800 NTU
Formazin RapidCal (0–40 NTU)	Typically deionized or distilled water ¹	20 NTU	–	–
Formazin (0–1000 NTU)	Typically deionized or distilled water ¹	20 NTU	100 NTU	800 NTU
Degrees (0–100 mg/L)	Typically deionized or distilled water ¹	20 NTU	100 NTU	–

¹ The water must have a turbidity <0.5 NTU to prepare the calibration standards.

StabiCal RapidCal calibration

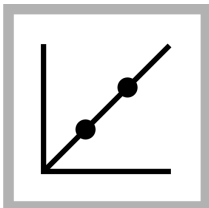

1. Push the **CALIBRATION** key to enter the Calibration mode. Follow the instructions on the display.

Note: Gently invert each standard before inserting the standard.

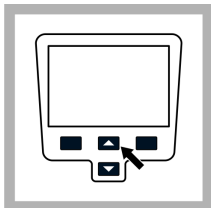

2. Push the **UP** and **DOWN** key to access Cal Options and then select Cal.Curve.

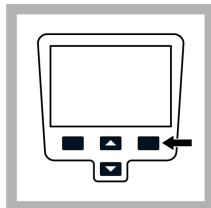

3. Select StabiCal RapidCal from the list and push **OK**.

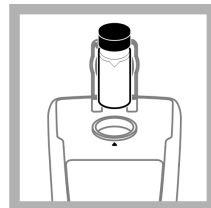

4. Insert the 20 NTU StabiCal Standard and close the lid.

Note: The standard to be inserted is bordered.

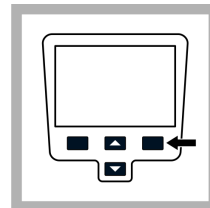

5. Push **Read**. The display shows Stabilizing and then shows the result.

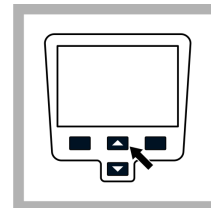

6. Push **Done** to review the calibration details.

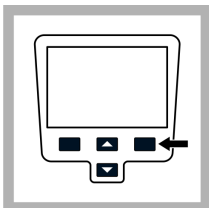

7. Push **Store** to save the results.

After a calibration is complete, the meter automatically goes into the Verify Cal mode, refer to [Calibration verification \(Verify Cal\)](#) on page 16.

Verification options

The Verification Options contain: Set Verification Standard, Set Acceptance Criteria and Verification Reminder.

1. Push the **Left** key (Verify Cal) and then the **UP** and **DOWN** keys.

Option	Description
Set Verification Standard	To change the verification standard use the UP and DOWN keys to enter a new standard value. Range 0.50–20.0 NTU (Default setting: 10.00 NTU) Range 0–20 NTU for RapidCal (0–40 NTU) 0–800 NTU for calibration curves with a range from 0–1000 NTU
Set Acceptance Criteria	Enter the Acceptance Criteria for comparison against the initial calibration verification reading to determine passing or failing. Range 1–50% (Default setting: 10%)
Verification Reminder	Verification Reminder—The meter will make an audible sound when verification is due. Select one of the following options for time interval and push OK : Off, 30 min (Default setting), 2 h, 4 h, 8 h, 24 h Allow Defer—Push Allow Defer and select Yes or No to postpone the verification due time

Calibration verification (Verify Cal)

The manufacturer recommends a calibration verification once a week. After a calibration is complete, the meter automatically goes into the Verify Cal mode.

Make sure that the sample cell is clean. Oil the sample cell with silicone oil, refer to [Apply silicone oil to a sample cell](#) on page 17. Check the

standard solution. Prepare a formazin standard at the same value and read the value.

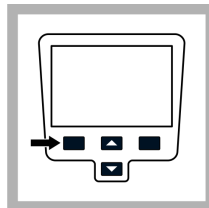

1. Push **Verify Cal** to enter the Verify menu.

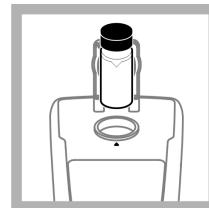

2. Gently invert the standard. Insert the 10.0 NTU (or other defined value) Verification Standard and close the lid.

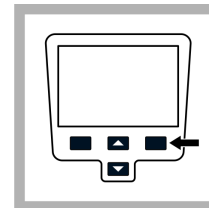

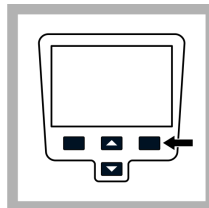

3. Push **Read**. The display shows **Stabilizing** and then shows the result and tolerance range.



4. Push **Done** to return to the reading display. Repeat the calibration verification if the verification failed.

Reading modes

1. Push the **UP** or **DOWN** key to enter the Reading Options menu.
2. Select Reading Mode to select one of the following options:

Option	Description
Normal (Default setting)	The normal mode reads and averages three readings. The result is shown after the reading.
Signal Average 	<p>The Signal Average mode compensates for reading fluctuations caused by drifting of sample particles through the light path.</p> <p>The X-bar icon is shown on the display when signal averaging is on.</p> <p>The Signal Average mode measures 12 times and starts to show the average after three readings. The final result is the average of all 12 readings.</p>
Rapidly Settling Turbidity (RST) 	<p>The Rapidly Settling Turbidity (RST) mode calculates and continuously updates the turbidity reading of the sample to a confidence of 95%, based on the accumulated trend of the real time measured values.</p> <p>The RST mode is best used on samples that settle rapidly and continuously change in value. The reading is based on a correctly prepared sample that is homogeneous at the beginning of the reading. It is best applied to samples that are greater than 20 NTU. The sample must be mixed thoroughly by inversion immediately before inserting it into the meter.</p> <p>The target icon is shown on the display when the Rapidly Settling Turbidity is on.</p> <p>The Rapidly Settling Turbidity reads and calculates five readings while showing intermediate results.</p>

Apply silicone oil to a sample cell

Sample cells and caps must be extremely clean and free from significant scratches. Apply a thin coating of silicone oil on the outside of the sample cells to mask minor imperfections and scratches that may contribute to light scattering.

Note: Use only the provided silicone oil. This silicone oil has the same refractive index as the sample cell glass.

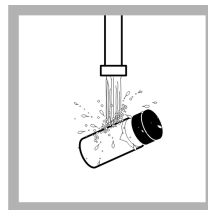

1. Clean the inside and outside of the cells and caps by washing with a laboratory glass cleaning detergent. Follow with multiple rinses with distilled or demineralized water.

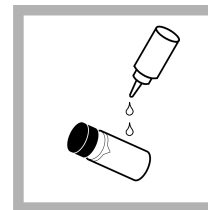

2. Apply a small bead of silicone oil from the top to the bottom of the cell.

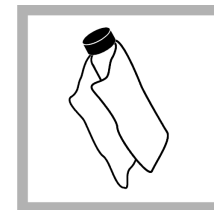

3. Use the provided oiling cloth to spread the oil uniformly. Wipe off the excess so that only a thin coat of oil is left. Make sure that the sample cell is almost dry with little or no visible oil.
Note: Store the oiling cloth in a plastic storage bag to keep the cloth clean.

Indexing a single cell

Precise measurements for very low turbidity samples require the use of a single cell for all measurements or optically matching the cells. Use one cell to provide the best precision and repeatability. When one cell is used, an index or orientation mark (other than the factory-placed diamond) can be placed on the cell so it is inserted into the instrument with the same orientation each time.

When using a single cell, make an index or orientation mark on the cell as follows:

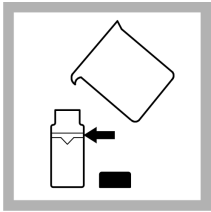

1. Fill the clean sample cell to the line with high quality water (< 0.5 NTU) and cap immediately. Let the sample cell degas for at least five minutes.



2. Wipe with lint-free cloth. Apply a thin film of silicone oil ([Apply silicone oil to a sample cell](#) on page 17).

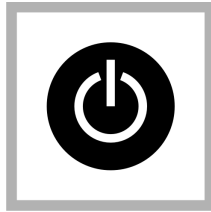

3. Push the **POWER** key to turn the meter on. Place the instrument on a flat, sturdy surface. **Note: Do not hold the instrument while making measurements.**

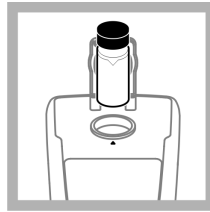

4. Insert the sample cell in the instrument cell compartment so the diamond or orientation mark always aligns with the raised orientation mark in front of the cell compartment. Close the lid.

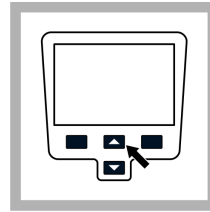

5. Push the **UP** and **DOWN** key to access the Reading Options and then select Indexing Sample Cell. **Note: The instruments always stays in the last selected reading mode.**

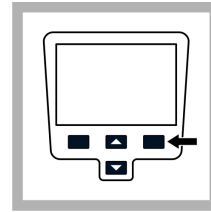

6. Push **Read**. The display shows Stabilizing then the turbidity in NTU. Record the cell position in the cell compartment and the reading result.

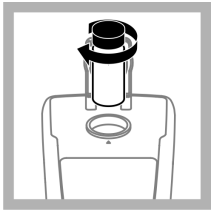

7. Remove the cell, rotate it slightly approximately $\frac{1}{8}$ of a turn and insert it again into the cell compartment. Close the lid.

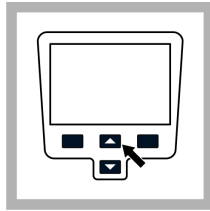

8. Push **Read**. Record the cell position in the cell compartment and the reading result.

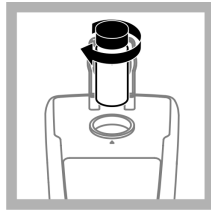

9. Repeat step 6 until the lowest reading is shown. Place an orientation mark on the cell marking band near the top of the cell so the cell can be consistently inserted in the position that yields the lowest reading.

Maintenance

⚠ CAUTION



Multiple hazards. Only qualified personnel must conduct the tasks described in this section of the document.

Clean the meter

The meter is designed to be maintenance-free and does not require regular cleaning for normal operation. Exterior surfaces of the meter may be cleaned as necessary.

Note: Do not clean the meter with solvents to avoid damaging the material.

1. Clean the meter with a dust- and lint-free dry or slightly damp cloth. A mild soap solution can also be used for liposoluble contamination.

Store the sample cells

NOTICE

Do not air dry the sample cells.

Note: Always store the sample cells with caps on to prevent the cells from drying.

1. Fill the sample cells with distilled or demineralized water.
2. Cap and store the sample cells.
3. Wipe the outside of the sample cells dry with the a soft cloth.

Replace the battery

⚠ WARNING



Explosion hazard. An expired battery can cause hydrogen gas buildup inside the instrument. Replace the battery before it expires. Do not store the instrument for long periods with a battery installed.

⚠ WARNING

Potential fire hazard. Use only alkaline or nickel metal hydride batteries (NiMH) in the meter. Other battery types or incorrect installation can cause a fire. Never mix battery types in the meter.

For battery replacement refer to [Install the battery](#) on page 6.

1. Remove the battery cover.
2. Remove the batteries.
3. Install 4 AA alkaline or 4 AA nickel metal hydride (NiMH) batteries. Make sure that the batteries are installed in the correct orientation.
4. Replace the battery cover.

Replace the lamp

⚠ CAUTION

Burn Hazard. Wait until lamp cools down. Contact with the hot lamp can cause burns.

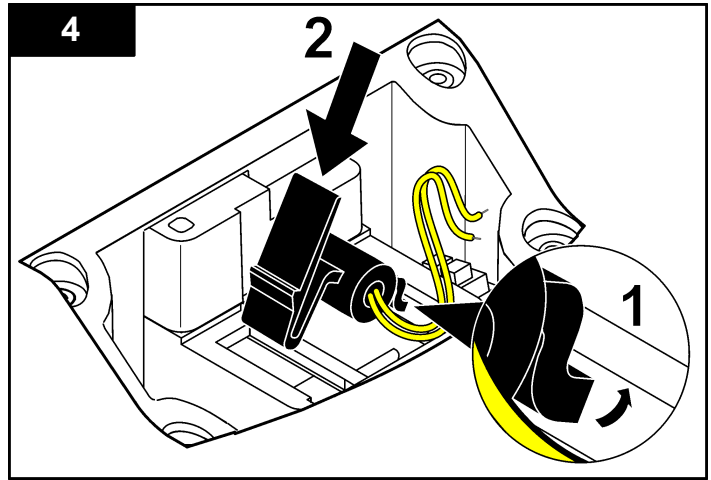
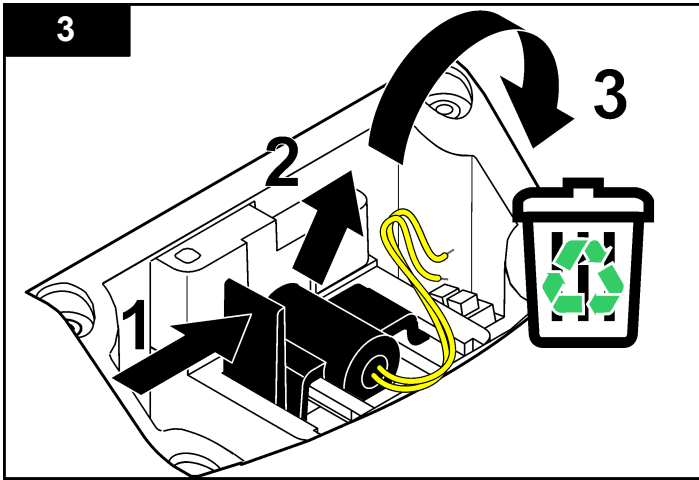
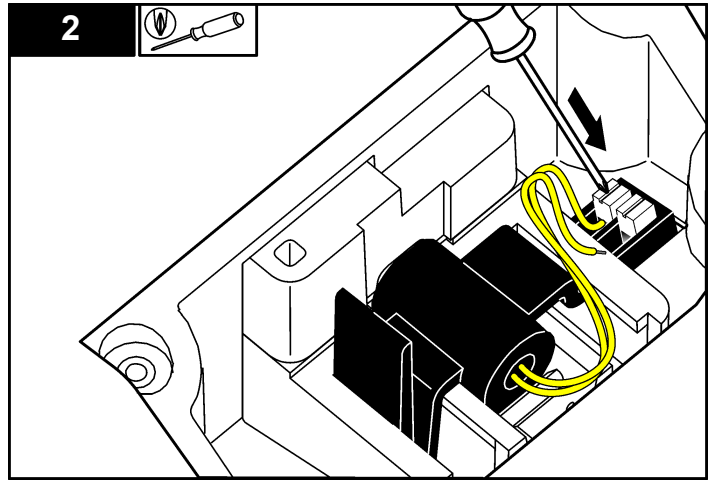
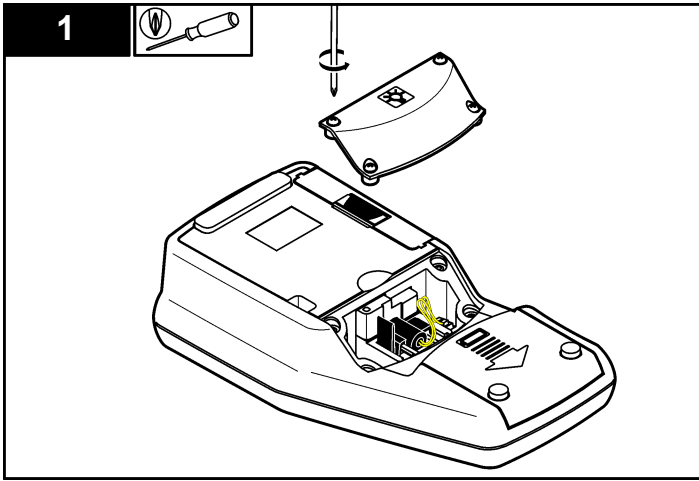

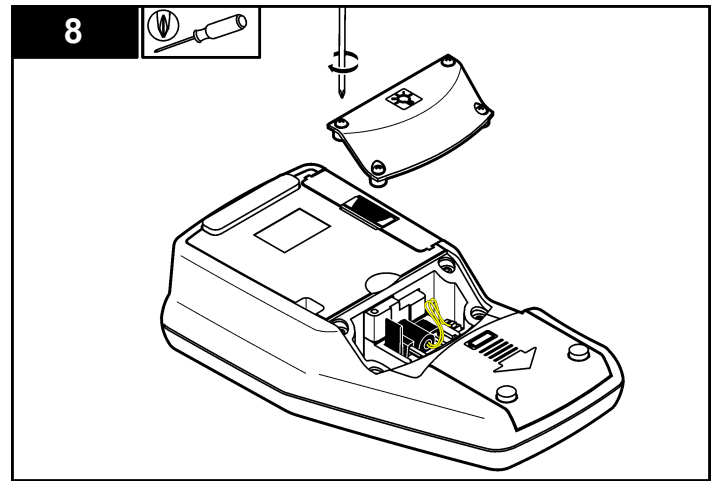
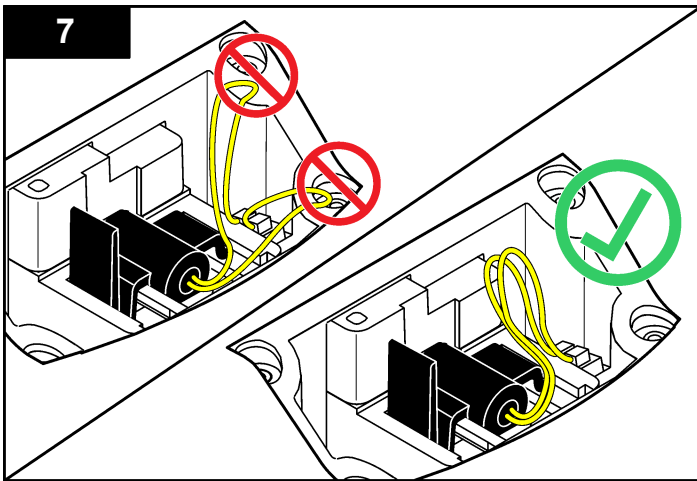
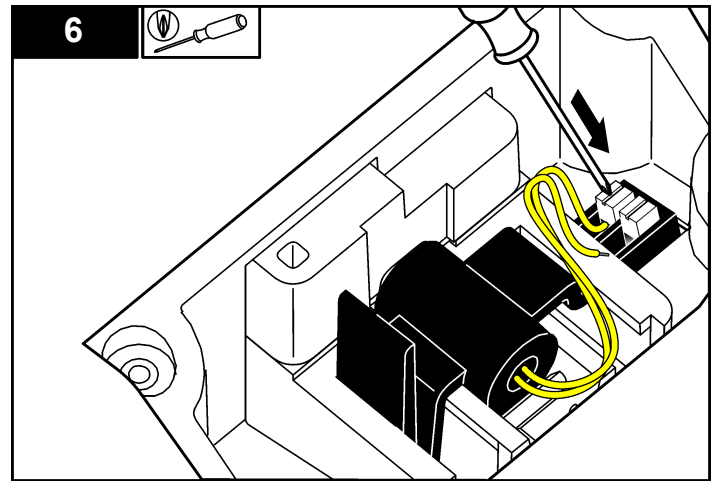
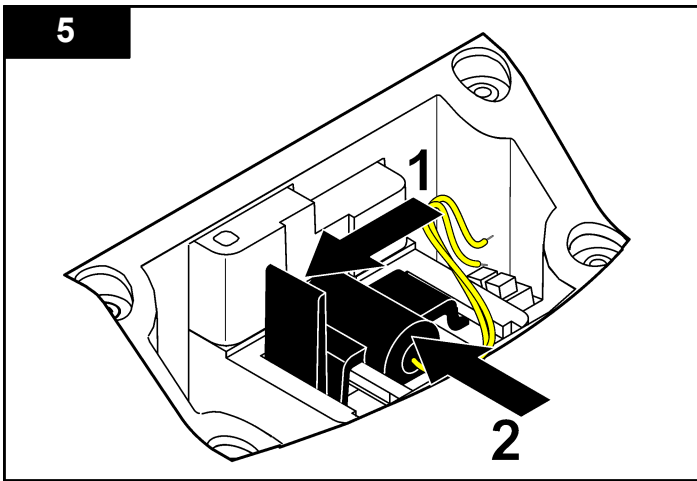

Troubleshooting

Refer to the following table for common problem messages or symptoms, possible causes and corrective actions.

Error/Warning	Description	Solution
Close lid and push Read.	The lid is open or lid detection failed.	Make sure that the lid is closed during reading and re-read.
Low Battery!	Battery is low.	<ul style="list-style-type: none"> Insert new batteries Connect USB/power module if rechargeable batteries are used
ADC Failure!	Hardware error causing reading to fail.	Repeat the reading.
Detector signal too low!	Insufficient light on the 180° detector.	<ul style="list-style-type: none"> Check for obstructed light path. Check the lamp.
Overrange!	Turbidity too high-caused probably by calibrating with RapidCal only.	<ul style="list-style-type: none"> Calibrate the upper range. Dilute the sample.
Underrange!	The measured absorbance is below the calibration range.	Repeat calibration
Please check the lamp!	Signals are too low on the 90° and 180° detector.	<p>2100Q: The lamp is defective. Change the lamp (refer to Replace the lamp on page 19).</p> <p>2100Qis: Contact technical support.</p>

Error/Warning	Description	Solution
Temperature too high! Switch off instrument.	Temperature has exceeded the meter limits (>60 °C or >140 °F).	Turn off the meter and let it cool down.
RST: Average value!	Solids are settling too slowly. The reading mode is not suitable for this sample.	Select Normal or Signal Average reading mode.
Confidence level is < 95%	The reading mode Rapidly Settling Turbidity did not meet the range of ≥ 95% confidence.	<ul style="list-style-type: none"> Invert the sample several times so that the solids allocate. Repeat the reading again. Switch to the Normal reading mode if the sample is stable and does not have settleable solids.
Standard value out of range. Insert standard and push Read	Used incorrect standard value for the reading.	Insert the appropriate standard and read again.
ID already in use. Enter new ID	The Operator or Sample ID is unavailable as it is already assigned.	Create a new ID.
Error - Security Please set password before activating security	No password is created.	Create a new password.
Please enter at least one character.	Password must contain minimum of one character.	Create a password of at least one character.
Password incorrect. Please retry.	Incorrect password was entered.	Enter the appropriate password.

Error/Warning	Description	Solution
Please disconnect the USB cable from your computer.	Data storage does not respond while connected to the meter and the computer.	Disconnect the USB cable from the meter and try sending data again.
USB module memory full. Delete data and try again.	Data storage is full.	<ol style="list-style-type: none"> 1. Connect USB/power module to the computer. 2. Download the stored data to the computer. 3. Delete Data Log on the module.
Delete Last Reading Failed!	Error in the data storage.	Turn the meter off and on. If the error message still occurs, contact technical support.
Delete Data Log failed!		
Can't read data set!		
Can't store data!		
Can't store to the Reading Log!		
Can't store to the Verify Cal Log!		
Error storing data!		
Error reading data!		

Replacement parts and accessories

Replacement parts

Description	Quantity	Item no.
StablCal ampule calibration kit	1	2971205
10 NTU verification standard	100 mL	2961701

Replacement parts (continued)

Description	Quantity	Item no.
Silicone Oil	15 mL	126936
Insert, molded bottom	1	2971507
Sample cell oiling cloth	1	4707600
1" glass sample cell (10 ml) w/cap (Turb)	pkg/6	2434706
Carrying case (includes insert)	1	2971500
Battery set, AA alkaline batteries	pkg/4	1938004
Lamp assy	1	4653900
Blank module	1	LZV797
Rubber foot set	1	LZV821
Lamp cover (includes screws)	1	LZV822
Battery cover (includes 2 feet)	1	LZV823
Module cover	1	LZV824
Connector cover for USB/power module	1	LZV825
Connector cover for power module	1	LZV826
Lid (includes magnet)	1	LZV827

Accessories

Description	Quantity	Item no.
USB/power module (includes: universal power supply, USB cable, instruction sheet)	1	LZV813.99.00002 ²
Power module (includes: universal power supply, instruction sheet)	1	LZV804.99.00002 ¹

² Not available in all regions

Accessories (continued)

Description	Quantity	Item no.
USB module with USB cable (2x)	1	LZV949.99.00002 ¹
StablCal 0.1 NTU Standard	100 mL	2723342
StablCal 0.3 NTU Standard	100 mL	2697943
StablCal 0.5 NTU Standard	100 mL	2698042
StablCal calibration kit	100 mL	2971210
StablCal calibration kit	500 mL	2971200
Gelex secondary standards set	1	2464105
Deionized water	4 vials	27217
Filter	0.2 micron	2323810
Formazin	500 ml	246149
Formazin	1000 ml	246142
Sample degassing kit	1	4397500
Sample degassing and filtration kit	1	4397510
Battery, NiMH AA	pk/4	2971304

A		meter components	5
auto-shutoff	12	meter specifications	3
B		meters	
backlight	12	troubleshooting	22
battery installation	6, 19	N	
C		normal reading	17
calibration	13	O	
contrast, display	12	operator ID	9
D		orientation mark	17
data, calibration log	11	P	
data, data log	11	parts list	23, 24
data, reading log	11	power	
data, stored data	11	battery installation	6, 19
data, verification log	11	R	
date and time	9	rapidly settling turbidity (RST)	17
display	8	reading mode	17
I		S	
Indexing a sample cell	17	sample ID	9
K		security options	13
keypad	7	signal average reading	17
L		silicone oil	17
language	8	sound options	13
M		stored data, send	12
menu navigation	8		

Index

V

verification 16

HACH COMPANY World Headquarters

P.O. Box 389, Loveland, CO 80539-0389 U.S.A.

Tel. (970) 669-3050

(800) 227-4224 (U.S.A. only)

Fax (970) 669-2932

orders@hach.com

www.hach.com

HACH LANGE GMBH

Willstätterstraße 11

D-40549 Düsseldorf, Germany

Tel. +49 (0) 2 11 52 88-320

Fax +49 (0) 2 11 52 88-210

info-de@hach.com

www.de.hach.com

HACH LANGE Sàrl

6, route de Compois

1222 Vérenaz

SWITZERLAND

Tel. +41 22 594 6400

Fax +41 22 594 6499

