



**KERN & Sohn GmbH**

Ziegelei 1  
D-72336 Balingen  
E-Mail: [info@kern-sohn.com](mailto:info@kern-sohn.com)

Tel: +49-[0]7433-9933-0  
Fax: +49-[0]7433-9933-149  
Internet: [www.kern-sohn.com](http://www.kern-sohn.com)

# Operating instructions

## Personal floor scale with BMI function

### **KERN MPE**

- Type MPE 250K100HM
- Type MPE 250K100PM
- Type MPE 250K100HNM
- Type MPE 250K100PNM

Version 4.1  
2017-09  
GB



MPE\_HM / MPE\_PM-BA-e-1741

- D** Weitere Sprachversionen finden Sie online unter [www.kern-sohn.com/manuals](http://www.kern-sohn.com/manuals)
- BG** Други езикови версии ще намерите в сайта [www.kern-sohn.com/manuals](http://www.kern-sohn.com/manuals)
- DK** Flere sprogudgaver findes på websiden [www.kern-sohn.com/manuals](http://www.kern-sohn.com/manuals)
- EST** Muud keeleversioonid leiate Te leheküljel [www.kern-sohn.com/manuals](http://www.kern-sohn.com/manuals)
- E** Más versiones de idiomas se encuentran online bajo [www.kern-sohn.com/manuals](http://www.kern-sohn.com/manuals)
- GR** Άλλες γλωσσικές αποδόσεις θα βρείτε στην ιστοσελίδα [www.kern-sohn.com/manuals](http://www.kern-sohn.com/manuals)
- F** Vous trouverez d'autres versions de langue online sous [www.kern-sohn.com/manuals](http://www.kern-sohn.com/manuals)
- LV** Citas valodu versijas atradīsiet vietnē [www.kern-sohn.com/manuals](http://www.kern-sohn.com/manuals)
- FIN** Muut kieliversiot löytyvät osoitteesta [www.kern-sohn.com/manuals](http://www.kern-sohn.com/manuals)
- LT** Kitas kalbines versijas rasite svetainėje [www.kern-sohn.com/manuals](http://www.kern-sohn.com/manuals)
- GB** Further language versions you will find online under [www.kern-sohn.com/manuals](http://www.kern-sohn.com/manuals)
- RO** Alte versiuni lingvistice veți găți pe site-ul [www.kern-sohn.com/manuals](http://www.kern-sohn.com/manuals)
- I** Trovate altre versioni di lingue online in [www.kern-sohn.com/manuals](http://www.kern-sohn.com/manuals)
- SK** Iné jazykové verzie nájdete na stránke [www.kern-sohn.com/manuals](http://www.kern-sohn.com/manuals)
- NL** Bijkomende taalversies vindt u online op [www.kern-sohn.com/manuals](http://www.kern-sohn.com/manuals)
- SLO** Druge jezikovne različice na voljo na spletni strani [www.kern-sohn.com/manuals](http://www.kern-sohn.com/manuals)
- P** Encontram-se online mais versões de línguas em [www.kern-sohn.com/manuals](http://www.kern-sohn.com/manuals)
- CZ** Jiné jazykové verze najdete na stránkách [www.kern-sohn.com/manuals](http://www.kern-sohn.com/manuals)
- PL** Inne wersje językowe znajdą Państwo na stronie [www.kern-sohn.com/manuals](http://www.kern-sohn.com/manuals)
- SE** Övriga språkversioner finns här: [www.kern-sohn.com/manuals](http://www.kern-sohn.com/manuals)
- H** A további nyelvi változatok a következő oldalon található: [www.kern-sohn.com/manuals](http://www.kern-sohn.com/manuals)
- HR** Druge jezične verzije su dostupne na stranici: [www.kern-sohn.com/manuals](http://www.kern-sohn.com/manuals)
- LT** Kitas kalbines versijas rasite svetainėje [www.kern-sohn.com/manuals](http://www.kern-sohn.com/manuals)
- NO** Andre språkversjoner finnes det på [www.kern-sohn.com/manuals](http://www.kern-sohn.com/manuals)



# KERN MPE

Version 4.1 2017-09

## Operating instructions

### Personal floor scale with BMI function

#### Contents

<b>1</b>	<b>Technical data</b> .....	<b>5</b>
<b>2</b>	<b>Declaration of conformity</b> .....	<b>7</b>
2.1	Explanation of the graphic symbols for medical devices.....	7
<b>3</b>	<b>Appliance overview</b> .....	<b>10</b>
<b>4</b>	<b>Keyboard overview</b> .....	<b>12</b>
<b>5</b>	<b>Overview of display</b> .....	<b>13</b>
<b>6</b>	<b>Basic Information (General)</b> .....	<b>14</b>
6.1	Specific function.....	14
6.2	Proper use .....	14
6.3	Improper Use .....	15
6.4	Warranty .....	15
6.5	Monitoring of Test Resources .....	15
<b>7</b>	<b>Basic Safety Precautions</b> .....	<b>16</b>
7.1	Pay attention to the instructions in the Operation Manual.....	16
7.2	Personnel training.....	16
7.3	Preventing contamination.....	16
<b>8</b>	<b>Electromagnetic compatibility (EMC)</b> .....	<b>17</b>
8.1	General hints .....	17
8.2	Electromagnetic interferences.....	18
8.3	Electromagnetic noise immunity.....	19
8.3.1	Crucial features of performance.....	22
8.4	Minimum distances .....	22
<b>9</b>	<b>Transport and storage</b> .....	<b>23</b>
9.1	Testing upon acceptance .....	23
9.2	Packaging / return transport.....	23
<b>10</b>	<b>Unpacking, Setup and Commissioning</b> .....	<b>24</b>
10.1	Installation Site, Location of Use .....	24
10.2	Unpacking.....	24
10.3	Scope of delivery .....	25
10.3.1	MPE-HM models .....	25
10.3.2	MPE-PM models .....	25
10.4	Balance assembly and installation .....	25
10.5	Mains connection.....	25
10.6	Battery operation is possible by obtaining an optional battery power pack. ....	26
10.7	Battery operation.....	27
10.8	Initial Commissioning .....	28

<b>11</b>	<b>Operation .....</b>	<b>29</b>
11.1	Weighing.....	29
11.2	Taring .....	29
11.2.1	Subsequent tare weight .....	30
11.3	HOLD function .....	30
11.4	Show second decimal place.....	30
11.5	Calculation of the Body Mass Index .....	31
11.5.1	Measuring body height (MPE-HM only) .....	31
11.5.2	Calculating Body Mass Index.....	32
11.5.3	Classification of BMI values .....	33
11.6	Automatic switch-off function „AUTO OFF“ .....	34
11.7	Display background illumination.....	35
<b>12</b>	<b>The menu .....</b>	<b>36</b>
12.1	Navigation in the menu .....	36
12.2	Menu overview.....	37
<b>13</b>	<b>Data output RS 232 .....</b>	<b>40</b>
13.1	Pin allocation of balance output bushing: .....	40
13.2	Technical data .....	40
13.3	Printer operation .....	41
<b>14</b>	<b>Error messages .....</b>	<b>42</b>
<b>15</b>	<b>Service, maintenance, disposal .....</b>	<b>43</b>
15.1	Cleaning .....	43
15.2	Cleaning / disinfecting .....	43
15.3	Sterilisation .....	43
15.4	Disposal.....	43
<b>16</b>	<b>Instant help .....</b>	<b>44</b>
<b>17</b>	<b>Verification.....</b>	<b>45</b>
17.1	Verification validity period (current status in G) .....	47
<b>18</b>	<b>Adjustment .....</b>	<b>48</b>

## 1 Technical data

<b>KERN (Type)</b>	<b>MPE 250K100HNM</b>	<b>MPE 250K100PNM</b>
Trademark	MPE 250K100HM	MPE 250K100PM
Display	6-digit	
Weighing range (max)	250 kg	
Minimum load (Min)	2 kg	
Verification value (e)	100 g	
Reproducibility	0.1 kg	
Linearity ±	0.1 kg	
Display	LCD with 25mm high digits	
Recommended adjustment weight, (Class)	≥ 200 kg (M1)	
Stabilization time (typical)	3 sec.	
Warm-up time	10 min	
Operating temperature	0° C .... + 40° C	
Humidity of air	max. 80 % (not condensing)	
Electric Supply	Input voltage 100 V - 240 V, 50 / 60 Hz	
Auto Off	After 3 min without load change (adjustable)	
Balance (W x D x H) mm	365 x 460 x 2134	365 x 450 x 1030
Weighing plate mm	365 x 360 x 80	
Weight kg (net)	11.5	10.8
Verification according to 2014/31/EU	medical, class III	
Medical device according to 93/42/EEC	class I with measuring function	
Height measuring stick in tripod integrated, extendable (from 88 cm to 200 cm)	✓	-
Rechargeable battery operation	optional; 6 x 1.2 VAA = 7.2 V/2000 mA	
Batteries	6 x 1.5 V AA	
Data interface provided as standard	RS 232 C	

<b>KERN (Type)</b>	<b>MPE 250K100HM</b>	<b>MPE 250K100PM</b>
Display	6-digit	
Weighing range (max)	250 kg	
Minimum load (Min)	2 kg	
Verification value (e)	100 g	
Reproducibility	0.1 kg	
Linearity ±	0.1 kg	
Display	LCD with 25mm high digits	
Recommended adjustment weight, (Class)	≥ 200 kg (M1)	
Stabilization time (typical)	3 sec.	
Warm-up time	10 min	
Operating temperature	0° C .... + 40° C	
Humidity of air	max. 80 % (not condensing)	
Electric Supply	Input voltage 100 V - 240 V, 50 / 60 Hz	
Auto Off	After 3 min without load change (adjustable)	
Balance (W x D x H) mm	365 x 460 x 2134	365 x 450 x 1030
Weighing plate mm	365 x 360 x 80	
Weight kg (net)	11.5	10.8
Verification according to 2014/31/EU	medical, class III	
Medical device according to 93/42/EEC	class I with measuring function	
Height measuring stick in tripod integrated, extendable (from 88 cm to 200 cm)	✓	-
Rechargeable battery operation	optional; 6 x 1.2 VAA = 7.2 V/2000 mA	
Batteries	6 x 1.5 V AA	
Data interface provided as standard	RS 232 C	

## 2 Declaration of conformity

To view the current EC/EU Declaration of Conformity go to:

[www.kern-sohn.com/ce](http://www.kern-sohn.com/ce)

**i** The scope of delivery for verified weighing balances (= conformity-rated weighing balances) includes a Declaration of Conformity. Solely these weighing balances are classified as medical devices.

### 2.1 Explanation of the graphic symbols for medical devices

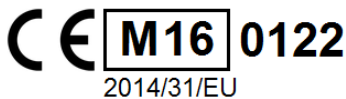

This marking indicates that these weighing balances are in conformity with EU Directive 2014/31/EU for non-automatic weighing balances. Weighing balances bearing this marking are licensed for medical purposes in the European Union.

The number inside the frame "M16" (example shown year 16) documents the year of conformity assessment.



This marking shows that this weighing balance is in conformity with EU Directive 93/42/EEC and inside the European Community is classified as medical device.

**WF 170012**

Designation of the serial number of every device, applied at the device and on the packaging

Number here as example



Identification of the manufacturing date of the medical product.

Year and month here as example



"Please note the accompanying documents"  
or "Please note the operating instructions"



“Please note the operating instructions”



“Please note the operating instructions”



Identification of manufacturer of medical product including address

**Kern & Sohn GmbH**  
D-72336 Balingen, Germany  
[www.kern-sohn.com](http://www.kern-sohn.com)



“Electro-medical appliance”  
with attachment for type B

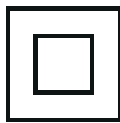

Device protection category II

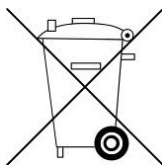

Dispose of old appliances separately from your household waste!

Instead, take them to communal collection points.

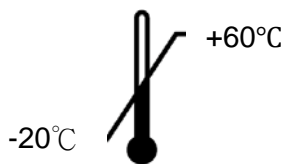

Temperature limit indicating the lower limit (-20°C) and the upper (+60°C) limit  
(storage temperature on packaging)

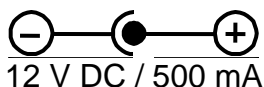

Display of supply voltage for scales with polarity display.





Mains connection



Sealing mark KERN SEAL



Supply voltage direct current



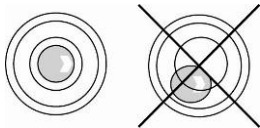

Information

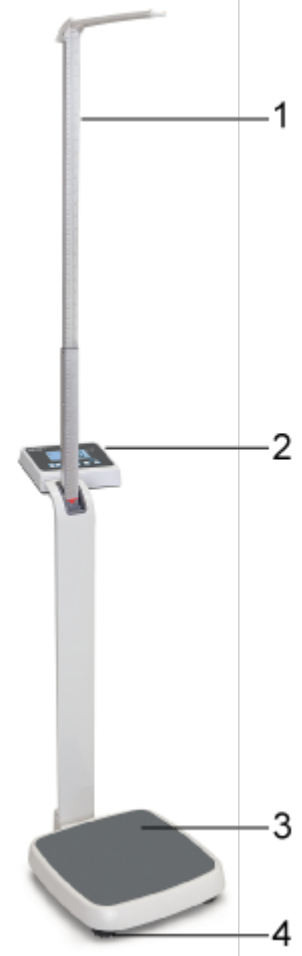

Level balance before use

### 3 Appliance overview

 <p>A front view of a white medical scale. A vertical measuring stick extends from the top of the scale's column. A display unit is mounted on the column. The weighing platform is at the base. The scale is supported by four adjustable feet.</p>	<ol style="list-style-type: none"><li>1. Height measuring stick (MPE-HM models only)</li><li>2. Display Unit</li><li>3. Weighing platform (anti-slip surface)</li><li>4. Rubber feet (height adjustable)</li></ol>
<p>Underside</p>  <p>A view of the underside of the weighing platform. It shows four black, adjustable rolls (casters) at the corners. A central panel with a cross-shaped logo is visible.</p>	<ol style="list-style-type: none"><li>5. Rolls</li></ol>

Secondary display at rear



Display unit at rear

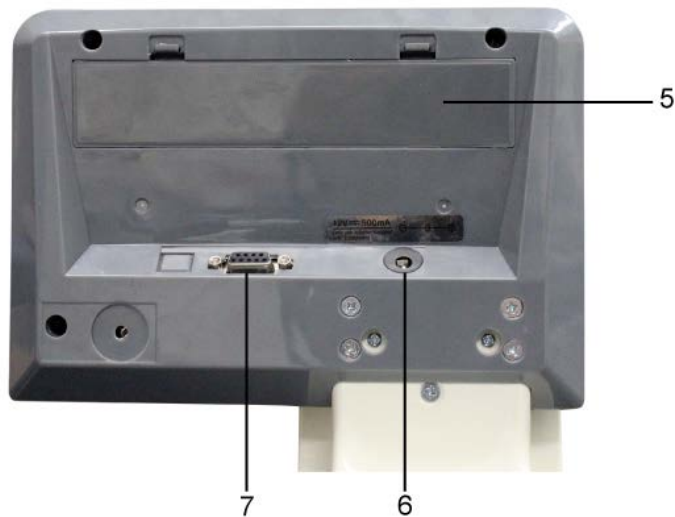

- 5 Rechargeable battery compartment
- 6 Mains connection
- 7 RS 232 C



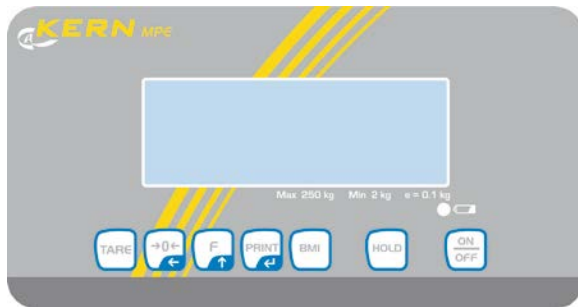

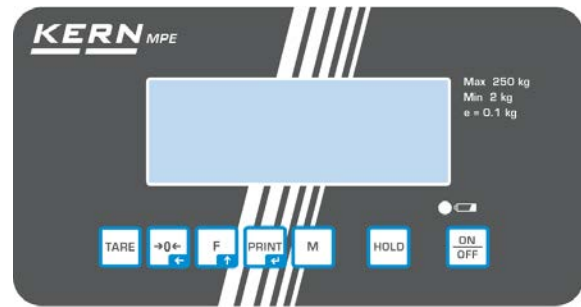

## 4 Keyboard overview





Type MPE 250K100HM  
Type MPE 250K100PM



Type MPE 250K100HNM  
Type MPE 250K100PNM

Key	Description	Function
	ON/OFF-switch	Turn on/off
	HOLD button	Hold function/Calculation of a stable weight value
	BMI key	Calculation of the Body Mass Index
	PRINT button	Data transfer via interface <b>In menu:</b> <ul style="list-style-type: none"> <li>• Confirm selection</li> </ul> <b>For numeric entry:</b> <ul style="list-style-type: none"> <li>• Confirm numerical value</li> </ul>
	Function key	<b>In menu:</b> <ul style="list-style-type: none"> <li>• Call up menu</li> <li>• How to select menu items</li> </ul> <b>For numeric entry:</b> <ul style="list-style-type: none"> <li>• Increase numerical value</li> </ul>
	Zeroing key	Weighing scale will be reset to „0.0“ <b>For numeric entry:</b> <ul style="list-style-type: none"> <li>• Change decimal place</li> </ul>
	TARE key	Tare balance

## 5 Overview of display

Display	Description	Description
	Stability display	Scales are in a steady state
	Zeroing display	Should the balance not display exactly zero despite empty weighing plate, press the  button. Your balance will be set to zero after a short standby time.
<b>NET</b>	Net weight display	Illuminated when net weight is displayed Illuminated after weighing scale was tared
<b>GROSS</b>	Gross weight display	Illuminated when gross weight is displayed
<b>HOLD</b>	HOLD function	HOLD function active
<b>BMI</b>	BMI function	Illuminated while BMI function is enabled

## 6 Basic Information (General)



Weighing instruments have to be verified for the purposes stated below in accordance with Directive 2014/31/EC. Article 1, paragraph 4. "Determination of mass in the practice of medicine that is, weighing patients for reasons of medical supervision during medical surveillance, examination and treatment."

### 6.1 Specific function

- Indication**
- Determining the body weight in the medical practice area.
  - Use as „non-standalone weighing scale“, that is, a person steps carefully onto the weighing platform's centre. Once a steady display value is shown, you can read the weight value.

- Contra-indication**
- No contraindication known

### 6.2 Proper use

This weighing scale is designed for determining the weight of a person whilst standing, such as in doctor's surgeries. The balance is suitable for recognising, preventing and controlling illnesses.



Scales fitted with a serial interface may only be connected to appliances in compliance with Directive EN60601-1.

On personal weighing scales, the person should step onto the centre of the weighing platform and remain standing without moving.

As soon as a stable weighing value is reached the weighing value can be read. The weighing scale is designed for continuous duty.



The weighing platform may only be stepped on by persons capable of standing on both feet on the weighing platform.

The weighing platforms are fitted with an anti-slip surface that must not be covered during weighing a person.

The balance should be checked for correct condition prior to each utilisation by a person familiar with proper operation of the balance.

### **6.3 Improper Use**

Do not use these scales for dynamic weighing processes.

Do not leave permanent load on the weighing pan. This may damage the measuring system.

Impacts and overloading exceeding the stated maximum load (max) of the weighing plate, minus a possibly existing tare load, must be strictly avoided. This could cause damage to the balance.

Never operate balance in explosive environment. The serial version is not explosion protected. It should be noted that a flammable mixture of anaesthetics and oxygen or laughing gas may occur.

The structure of the balance may not be modified. This may lead to incorrect weighing results, safety-related faults and destruction of the balance.

The balance may only be used according to the described conditions. Other areas of use must be released by KERN in writing.

### **6.4 Warranty**

Warranty claims shall be voided in case

- Our conditions in the operation manual are ignored
- The appliance is used outside the described uses
- The appliance is modified or opened
- Mechanical damage and damage caused by media, liquids,
- Natural wear and tear
- The appliance is improperly set up or incorrectly electrically connected
- The measuring system is overloaded
- Dropping the balance



### **6.5 Monitoring of Test Resources**

In the framework of quality assurance the measuring-related weighing properties of the balance and, if applicable, the testing weight, must be checked regularly. The responsible user must define a suitable interval as well as type and scope of this test. Information is available on KERN's home page ([www.kern-sohn.com](http://www.kern-sohn.com)) with regard to the monitoring of balance test substances and the test weights required for this. In KERN's accredited DKD calibration laboratory test weights and balances may be calibrated (return to the national standard) fast and at moderate cost.

Using measuring technology to check the accuracy of the measuring device is recommended for personal floor scales with body height measurement but is not absolutely essential as the calculation of the human body height is always subject to a great deal of inaccuracy.

## 7 Basic Safety Precautions

### 7.1 Pay attention to the instructions in the Operation Manual

	⇒ Carefully read this operation manual before setup and commissioning, even if you are already familiar with KERN balances.	
---	---	---

### 7.2 Personnel training

The medical staff must apply and follow the operating instructions for proper use and care of the product.

### 7.3 Preventing contamination

The prevention of cross-contamination (fungal skin infections ...) requires regular cleaning of the weighing platform. Recommendation: after a weighing procedure that could potentially result in contamination (e. g. after weighing that involves direct skin contact).



---

## 8 Electromagnetic compatibility (EMC)

---

### 8.1 General hints



The installation and use of this electrical medical device requires special precautionary measures as outlined in the EMC information below.

This device complies with the limits set for medical electrical devices of group 1, class B (as per EN 60601-1-2).

Electromagnetic compatibility (EMC) describes a device's ability to perform reliably within an electromagnetic environment without causing inadmissible electromagnetic interference at the same time. Amongst other things, such disturbances may be emitted by connecting cables or the air.

Inadmissible disturbances from the environment may result in incorrect displays, inaccurate measured values or incorrect behaviour of the medical device. By the same token the medical device may in some cases cause such disturbances in other devices. To eliminate problems of that kind, we recommend you to take one or several of the measures listed below:

- Change the alignment or distance of the device to the source of EMI.
- Install or use the floor scales MPE 250K100HM, MPE 250K100PM, MPE 250K100HNM, MPE 250K100PNM at a different location.
- Connect the floor scales MPE 250K100HM, MPE 250K100PM, MPE 250K100HNM, MPE 250K100PNM to a different power source.
- For further questions please contact our customer services.

Disturbances may be caused by improper modification or add-ons to the device or not recommended accessories (such as power units or connecting cables). The manufacturer will not be responsible for these. Modifications may also result in a loss of authorisation relating to the use of the device.



Devices emitting high frequency signals (mobile telephones, radio transmitters, radio receivers) may cause interference in the floor scale MPE 250K100HM, MPE 250K100PM, MPE 250K100HNM, MPE 250K100PNM. For that reason do not use them near the floor scale MPE 250K100HM, MPE 250K100PM, MPE 250K100HNM, MPE 250K100PNM. Chapter 8.4 contains details about recommended minimum distances.

## 8.2 Electromagnetic interferences

<b>Guidelines and manufacturer's declaration – electromagnetic interferences</b>		
<p>The floor scales MPE 250K100HM, MPE 250K100PM, MPE 250K100HNM, MPE 250K100PNM is designed for use in an electromagnetic environment that meets the requirements stated below. The customer or user of the medical electrical device must ensure that operation takes place in such an environment.</p>		
<b>Emitted interference measurements</b>	<b>Conformity</b>	<b>Electromagnetic environment - guideline</b>
<p>HF emissions as per CISPR 11 / EN 55011</p>	<p>Group 1</p>	<p>The floor scales MPE 250K100HM, MPE 250K100PM, MPE 250K100HNM, MPE 250K100PNM uses HF energy merely for its internal working. Its HF emission therefore is very low and it is highly unlikely to interfere with adjacent electronic devices.</p>
<p>HF emissions as per CISPR 11 / EN 55011</p>	<p>Class B</p>	<p>The floor scales MPE 250K100HM, MPE 250K100PM, MPE 250K100HNM, MPE 250K100PNM is designed for use in all equipment including those in living areas and those connected directly to the public power grid that also supplies buildings used for living purposes.</p>
<p>Emission of harmonics as per IEC 61000-3-2</p>	<p>Class A</p>	
<p>Emission of voltage fluctuations / flicker as per IEC 61000-3-3</p>	<p>Conforms with</p>	

Do not put the floor scale MPE 250K100HM, MPE 250K100PM, MPE 250K100HNM, MPE 250K100PNM directly next to other devices and do not stack it with other devices. If this type of operation is necessary, observe the floor scale MPE 250K100HM, MPE 250K100PM, MPE 250K100HNM, MPE 250K100PNM to ensure normal operation in such an arrangement.

### 8.3 Electromagnetic noise immunity

<b>Guidelines and manufacturer's declaration - electromagnetic noise immunity</b>			
The floor scales MPE 250K100HM, MPE 250K100PM, MPE 250K100HNM, MPE 250K100PNM is designed for use in an electromagnetic environment that meets the requirements stated below. The customer or user of the medical electrical device must ensure that operation takes place in such an environment.			
<b>Noise immunity tests</b>	<b>IEC 60601 test level</b>	<b>Conformity</b>	<b>Electromagnetic environment - guideline</b>
Discharge static electricity (DSE) as per IEC 61000-4-2	± 6 kV contact discharge ± 8 kV air discharge	± 6 kV ± 8 kV	Floors should be made of wood or concrete or tiled with ceramic tiles. If floors are covered with synthetic material, relative air humidity must be at least 30%.
Fast transient electrical disturbances / bursts as per IEC 61000-4-4	± 2 kV for power lines ± 1 kV for input and output lines	± 2 kV ± 1 kV	The quality of the supply voltage should match that of the typical business or hospital environment.
Impulse voltages / surges as per IEC 61000-4-5	± 1 kV voltage Live wire - live wire ± 2 kV voltage Live wire - earth	± 1 kV Inapplicable	The quality of the supply voltage should match that of the typical business or hospital environment.
Voltage dips, short-term disruptions and fluctuations in supply voltage as per IEC 61000-4-11	< 5 % $U_T$ (> 95 % dip of $U_T$ ) for ½ period  40 % $U_T$ (> 60 % dip of $U_T$ ) for 5 periods  70 % $U_T$ (> 30 % dip of $U_T$ ) for 25 periods  < 5 % $U_T$ (> 95 % dip of $U_T$ ) for 5 s	Compliance with requirements under all postulated conditions  Controlled switch off Return to undisturbed situation after user intervention.	The quality of the supply voltage should match that of the typical business or hospital environment. Where the user of the medical device demands continuous operation even during disruptions to the power supply, we recommend powering the floor scale MPE by no-break power supply or battery.
Magnetic field for supply frequency (50/60 Hz) as per IEC 61000-4-8	3 A/m	3 A/m 50/60 Hz	Magnetic fields for the supply frequency should match the typical values found in the particular business or hospital environment.
<b>NOTE</b> $U_T$ equals AC line voltage prior to application of test level.			

## Guidelines and manufacturer's declaration - electromagnetic noise immunity

The floor scales MPE 250K100HM, MPE 250K100PM, MPE 250K100HNM, MPE 250K100PNM is designed for use in an electromagnetic environment that meets the requirements stated below. The customer or user of the medical electrical device must ensure that operation takes place in such an environment.

Noise immunity tests	IEC 60601 test level	Conformity	Electromagnetic environment - guideline
Conducted HF disturbance variables as per IEC 61000-4-6	3 $V_{rms}$ 150 kHz to 80 MHz	3 V	<p>Do not use portable or mobile radio sets nearer to the floor scales MPE 250K100HM, MPE 250K100PM, MPE 250K100HNM, MPE 250K100PNM or its wires than the distance recommended as safety distance which is calculated according to the equation relevant for its transmission frequency.</p> <p>Recommended safety distance:  <math>d = 1.2\sqrt{P}</math>  <math>d = 1.2\sqrt{P}</math>                      for 80 MHz to 800 MHz  <math>d = 2.3\sqrt{P}</math>                      for 800 MHz to 2.5 GHz</p> <p>Use P as rated capacity of radio transmitter in Watt (W) as per details given by the radio transmitter manufacturer and d as recommended safety distance in metres (m).</p> <p>The field intensity of stationary radio transmitters should for all frequencies be lower according to an in situ<sup>a</sup> examination than the conformity level.<sup>b</sup></p> <p>Interference may occur near devices bearing the symbol below.</p>
Emitted HF disturbance variables as per IEC 61000-4-3	3 $V_{rms}$ 80 MHz to 2.5 GHz	3 V/m	



NOTE 1 Higher frequency range applies to 80 MHz and 800 MHz.

NOTE 2 These guidelines may not be applicable in all cases.  
The spread of electromagnetic variables is influenced by absorption and reflections in buildings, objects and humans.

- <sup>a</sup> The field intensity of stationary radio transmitters such as base stations of wireless telephones and mobile radio sets, amateur radio stations, AM and FM radio and television stations cannot be reliably predicted in advance. To determine the electromagnetic environment in respect of stationary transmitters, you should consider a study of electromagnetic phenomena at the location. If the measured field intensity at the location where the floor scales MPE 250K100HM, MPE 250K100PM, MPE 250K100HNM, MPE 250K100PNM is to be used exceeds the conformity level above, you should observe the floor scales MPE 250K100HM, MPE 250K100PM, MPE 250K100HNM, MPE 250K100PNM in order to ensure normal operation. If you observe unusual features of performance you may have to take additional measures such as a change in alignment or a different location for the floor scale MPE 250K100HM, MPE 250K100PM, MPE 250K100HNM, MPE 250K100PNM.
- <sup>b</sup> For a frequency range of 150 kHz to 80 MHz field intensity should be less than 3 V/m.

### 8.3.1 Crucial features of performance



The floor scales MPE 250K100HM, MPE 250K100PM, MPE 250K100HNM, MPE 250K100PNM does not have any crucial features of performance as per IEC 60601-1. The system may be subject to interference by other devices even if these devices conform to current emission requirements as per CISPR.

### 8.4 Minimum distances

<b>Recommended safety distances between portable and mobile HF telecommunication devices and the medical device</b>			
<p>The floor scales MPE 250K100HM, MPE 250K100PM, MPE 250K100HNM, MPE 250K100PNM is designed for use in an electromagnetic environment in which HF disturbance variables are controlled. The customer or user of the medical electrical device can help avoiding electromagnetic disturbances by keeping the minimum distance between portable and mobile HF telecommunication devices (transmitters) and the floor scales MPE 250K100HM, MPE 250K100PM, MPE 250K100HNM, MPE 250K100PNM – depending on the output performance of the communication device, as stated below.</p>			
Rated capacity of transmitter W	The safety distance depends on the transmission frequency m		
	150 kHz to 80 MHz $d = 1.2\sqrt{P}$	80 MHz to 800 MHz $d = 1.2\sqrt{P}$	800 MHz to 2.5 GHz $d = 2.3\sqrt{P}$
0.01	0.12	0.12	0.23
0.1	0.38	0.38	0.73
1	1.20	1.20	2.30
10	3.80	3.80	7.30
100	12.00	12.00	23.00
<p>For transmitters with a maximum rated capacity not stated in the table above you can calculate the recommended safety distance in metres (m) yourself by using the equation belonging to each column, whereby P equals the maximum rated capacity of the transmitter in Watt (W) as per details provided by the transmitter manufacturer.</p>			
NOTE 1	Higher frequency range applies to 80 MHz and 800 MHz.		
NOTE 2	These guidelines may not be applicable in all cases. The spread of electromagnetic variables is influenced by absorption and reflections in buildings, objects and humans.		

## 9 Transport and storage

### 9.1 Testing upon acceptance

When receiving the appliance, please check packaging immediately, and the appliance itself when unpacking for possible visible damage.

### 9.2 Packaging / return transport



- ⇒ Keep all parts of the original packaging for a possibly required return.
- ⇒ Only use original packaging for returning.
- ⇒ Prior to dispatch disconnect all cables and remove loose/mobile parts.
- ⇒ Reattach possibly supplied transport securing devices.
- ⇒ Secure all parts such as the weighing platform, power unit etc. against shifting and damage.

## 10 Unpacking, Setup and Commissioning

### 10.1 Installation Site, Location of Use

The balances are designed in a way that reliable weighing results are achieved in common conditions of use.

You will work accurately and fast, if you select the right location for your balance.

**On the installation site observe the following:**

- Place scales on a stable, even surface;
- Avoid extreme heat as well as temperature fluctuation caused by installing next to a radiator or in the direct sunlight;
- Protect the balance against direct draughts due to open windows and doors;
- Avoid jarring during weighing;
- Protect the balance against high humidity, vapours and dust;
- Do not expose the device to extreme dampness for longer periods of time. Non-permitted condensation (condensation of air humidity on the appliance) may occur if a cold appliance is taken to a considerably warmer environment. In this case, acclimatize the disconnected appliance for ca. 2 hours at room temperature.
- Avoid static charge of the balance and of the person to be weighed.
- Avoid contact with water.

Major display deviations (incorrect weighing results) may be experienced should electromagnetic fields (e.g. due to mobile phones or radio equipment), static electricity accumulations or instable power supply occur. Change location or remove source of interference.

### 10.2 Unpacking

Remove the individual components of the balance or the complete balance from the packaging with care and install at the intended location. When using the power pack, ensure that the power cable does not produce a risk of stumbling.



### 10.3 Scope of delivery

#### Serial accessories:

#### 10.3.1 MPE-HM models

- Balance, fully assembled
- Power pack unit (EN 60601-1 attestation of conformity)
- Operating instructions
- Protective working cover

#### 10.3.2 MPE-PM models

- Weighing scale with tripod, fully assembled
- Power pack unit (EN 60601-1 attestation of conformity)
- Operating instructions
- Protective working cover

### 10.4 Balance assembly and installation

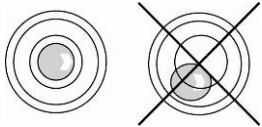

⇒ Level balance with foot screws until the air bubble of the water balance is in the prescribed circle.

⇒ Check levelling regularly.

### 10.5 Mains connection

Power is supplied by the external power unit which also serves to isolate the mains supply from the scale. The stated voltage value must be the same as the local voltage.

Always use genuine approved KERN power pack units as per EN 60601-1 directive.

The small sticker attached to the side of the display unit indicates the power port:



The LED remains illuminated as long as the weighing scale remains connected to the mains.

The LED display informs you during loading about the loading status of the rechargeable battery.

**green:** Rechargeable battery is completely discharged

**blue:** Charging rechargeable battery

## 10.6 Battery operation is possible by obtaining an optional battery power pack.

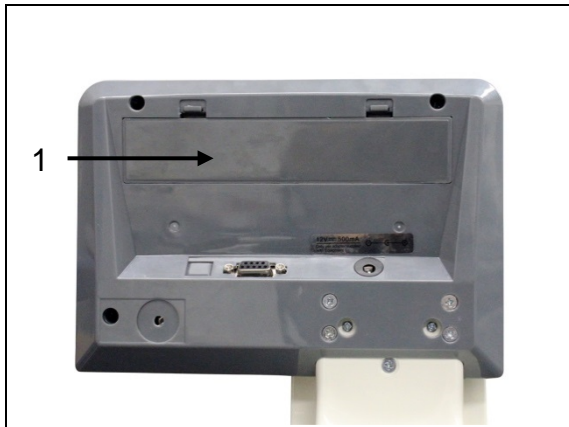

Open the battery compartment cover (1) at the base of the display unit and insert the rechargeable battery. Charge the battery for at least 12 hours before initial use.

The appearance of the symbol  in the weight display indicates that the battery is almost exhausted. The weighing scale will remain ready for operation for a few more minutes before switching off in order to save battery (s. chap. 11.6 Auto off). Load rechargeable battery.

 Voltage has dropped below prescribed minimum.

 Rechargeable battery very low.

 Rechargeable battery completely reloaded

If the balance is not used for a longer time, take out the rechargeable battery and store it separately. Leaking liquid could damage the balance.

## 10.7 Battery operation

As an alternative to rechargeable battery operation, the balance may also be operated with 6x AA batteries.

Open battery compartment cover (1) at the lower side of the display unit and insert batteries according to the example below. Lock the battery cover again. If the

batteries are empty, in the balance display appears the symbol .

Change batteries. To save battery power, the balance switches off automatically (see chap.11.6 Auto off).



Capacity of batteries exhausted.







Batteries will soon be flat.

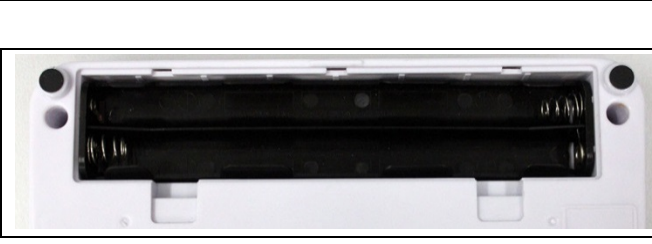

Batteries are completely charged

## Insert batteries

Remove battery compartment cover	
Connect battery holder to housing contact acc. to illustration	
Insert battery holder	
Insert batteries into battery compartment and lock with battery compartment cover.	

### 10.8 Initial Commissioning

In order to obtain exact results with the electronic balances, your balance must have reached the operating temperature (see warming up time chap. 1). During this warming up time the balance must be connected to the power supply (mains, accumulator or battery) and be switched on.

The accuracy of the balance depends on the local acceleration of gravity. The value of gravity acceleration is shown on the type plate.

## 11 Operation

### 11.1 Weighing



- ⇒ Start balance by pressing . The balance will carry out a self-test. The scales are ready for operation as soon as the weight display for "0.0 kg" has appeared.



- However, you can reset the weighing scale to zero by pressing the  key.

- ⇒ Have person stand in the centre of the scales. Wait until the standstill display „STABLE“ appears, then read the weighing result.



- If the person is heavier than the weighing range, "OL" (=overload) will appear in the display.

### 11.2 Taring

The tare weight of any preloads can be deducted by pressing a button so that the actual weight of the person is displayed in subsequent weighings.

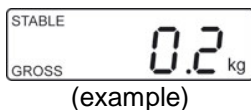

- ⇒ Put object (such as towel or padding) on the weighing pan.



- ⇒ Press , the zero display appears. „NET“ is shown at the bottom on the left.

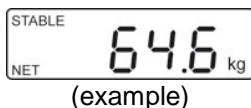

- ⇒ Allow the person to step onto the centre of the weighing platform. Wait until the standstill display „STABLE“ appears, then read the weighing result.



- When the balance is unloaded the saved taring value is displayed with negative sign.
- To delete the stored tare value, release scales and press .

### 11.2.1 Subsequent tare weight

The balance can be tared several times successively.

### 11.3 HOLD function

The balance has an integrated standstill function (mean value calculation). With this function it is possible to weigh people accurately even if they do not stand still on the weighing plate.

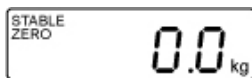

⇒ Start balance by pressing .  
Wait for stability display „STABLE“ to appear.

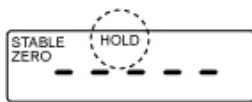

⇒ Press  in the display „-----“ will appear and the „HOLD“ symbol appears.

⇒ Allow the person to step onto the centre of the weighing platform.

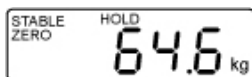

(Example)

⇒ After a short time the stability display „STABLE“ appears and the weighing value of the person is displayed and „frozen“.

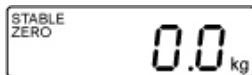

After unloading the balance, the weighing value remains displayed for approx. 10 seconds, than the balance changes automatically into the weighing mode.  
The symbol „HOLD“ disappears.



There is no average value calculation in the event of too much movement.

### 11.4 Show second decimal place

Press  and hold for about 2 s whilst weighed result is being shown. The second decimal place will be shown for approx. 5 s.

## 11.5 Calculation of the Body Mass Index

You need to know a person's body height before you can calculate the BMI for that person. It should either be known or can be determined directly with the MPE-HM model.

### 11.5.1 Measuring body height (MPE-HM only)



- ⇒ Push measuring stick upwards and set the stopper horizontally.
- ⇒ Push measuring rod carefully down until the headpiece touches the person's head. (It is recommended to take measurements with shoes removed).



**A fixed stopper pointing outwards poses a risk of injury.**



⇒ Read body height on measuring stick.

### 11.5.2 Calculating Body Mass Index



⇒ Start balance by pressing 

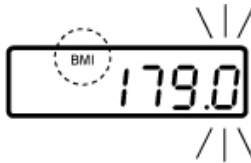

⇒ Wait for stability display „STABLE” to appear.



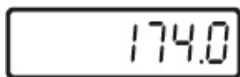

⇒ Press 

The most recently entered body height will be shown with the enable digit flashing. The „BMI” symbol lights up.

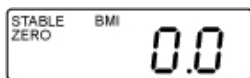

⇒ To enter body height, press the  and  key.





⇒ Confirm your entered value by pressing . BMI „0.0” is displayed

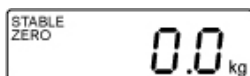

⇒ Allow the person to step onto the centre of the weighing platform.  
„-----”, is shortly displayed, followed by the BMI value of the person.

⇒ Unload weighing plate



⇒ To return to weighing mode, press . The BMI symbol will disappear and the kg display will reappear.





- Reliable calculation of BMI is restricted to a body height of 100 cm to 200 cm and a weight of >10 kg.
- If weighing has to take place under unsteady conditions, you can stabilise the display by applying the Hold function.

### 11.5.3 Classification of BMI values

Weight classification for adults over 18 years of age using the BMI in accordance with WHO, 2000 EK IV and WHO 2004.

<b>Categorie</b>	<b>BMI ( kg/m<sup>2</sup>)</b>	<b>Risk of diseases associated with overweight</b>
Underweight	< 18.5	low
Normal weight	18.5 – 24.9	Average
Overweight	≥ 25.0	
Pre-adipose	25.0 – 29.9	A bit high
Adipose degree I	30.0 – 34.9	High
Adipose degree II	35.0 – 39.9	up
Adipose degree III	≥ 40	Very high

## 11.6 Automatic switch-off function „AUTO OFF“

The weighing scale will switch off automatically after the allotted time as long as neither the display unit nor the weighing plate is operated.



- Menu settings:  
[F1 oFF] ⇒ [oFF 0/3/5/15/30] (see chap. 12)



⇒ Start balance by pressing .

⇒ Wait for stability display „STABLE“ to appear.



⇒ Press , [F1 oFF] is displayed



(example)

⇒ Press  to display the most recently set time, such as [oFF 15]

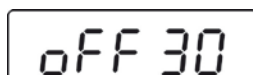

(example)

⇒ Press  repeatedly until the desired time is displayed, e.g. [oFF 30]

[oFF 0]	AUTO OFF - function disabled
[oFF 3]	Weighing system will be turned off after 3 min.
[oFF 5]	Weighing system will be turned off after 5 min.
[oFF 15]	Weighing system will be turned off after 15 min.
[oFF 30]	Weighing system will be turned off after 30 min.

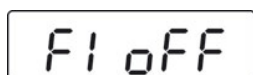

⇒ Use  to save the selected time, [F1 oFF] will be displayed



⇒ Return to weighing mode using 

## 11.7 Display background illumination



- Menu settings:  
[F4 bk] ⇒ [bL on / bL oFF / bL AU] see chap. (12)



⇒ Start balance by pressing

⇒ Wait for stability display „STABLE to appear.

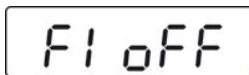

⇒ Press , [F1 oFF] is displayed

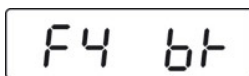

⇒ Press repeatedly until [F4 bk] is shown.

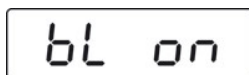

⇒ To display the most recent setting such as [bL on], press



(example)



⇒ To select the desired setting, press

**bL on** Continuous background lighting

**bL off** Background illumination off

**bL Auto** Automatic background illumination on when weighing pate is loaded or key pressed.

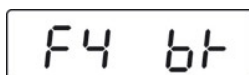

⇒ To save the selected setting, press and [F4 bk] will be displayed.



⇒ Return to weighing mode using

## 12 The menu









Access to service menu „tCH“ is locked in verified weighing scales. To disable the access lock, destroy the seal and actuate the adjustment switch. For position of adjustment switch, see chap. 16.





**Attention:**





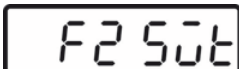
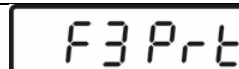

After destruction of the seal the weighing system must be re-verified by an authorised agency and a new verification wire/seal mark fitted before it can be reused for applications subject to verification.



### 12.1 Navigation in the menu

<p><b>Call up menu</b></p>	<p>⇒ In weighing mode, press  and the first function [F1 OFF] will be displayed.</p>
<p>Select function</p>	<p>⇒ With help of , the individual functions can be selected one after the other.</p>
<p><b>Change settings</b></p>	<p>⇒ Confirm selected function by pressing . The current setting will be displayed.</p> <p>⇒ To select the desired setting, press  and confirm your selection by ; the weighing scale will return to the menu.</p>
<p><b>Exit menu/ Return to weighing mode</b></p>	<p>⇒ Press  and the scales will return to weighing mode.</p>

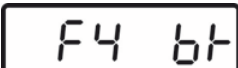
## 12.2 Menu overview

Menu block Main Menu	Menu item Submenu	Available settings / explanation
 Automatic cutout Auto Off	oFF 0*	Automatic shutdown off
	oFF 3	Automatic shutdown after 3 min
	oFF 5	Automatic shutdown after 5 min
	oFF 15	Automatic shutdown after 15 min
	oFF 30	Automatic shutdown after 30 min
	oFF	Not documented
	Prt	
	Pr ACC	
 Interface parameter	<b>1. RS-232 mode</b>	
	Select desired mode by  , then confirm with  .	
	P Prt	Weight will be added to summation memory and printed after pressing PRINT
	P Cont	Continuous data output
	Series	Not documented
	ASK	Remote control instructions: W: Send all weighing results S: Send stable weighing result T: Tare Z: Zero setting
	P cnt 2	Not documented
	P Stab	Automatic data output of stable weighing values
	P Auto	Weighed result will be added automatically to summation memory and issued
	<b>2. Baud rate</b>	
The currently set baud rate (b xxx) will be shown after the RS-232 mode was confirmed. Select desired Baudrate by pressing  and confirm by pressing  .		
Available Baudrate: 600, 1200, 2400, 4800, 9600		

		<b>3. Data output format</b> (P Prt, P Auto, P Cont settings only) the currently set data output format will be shown after the baud rate was confirmed. Select desired format by  and confirm with  .	
Only when set P, Prt, P	Prt 0-3	Data output format, see chap. 13.	
Only when set P Cont	Cont 1	Default	<b>Sd0 – on/off</b> Cont. data outputselectable „send 0“, yes / no
	Cont 2	Not documented	
	Cont 3	Not documented	
		<b>4. Printer type</b> After the data output format has been confirmed, the currently set printer type will be displayed. Select the desired printer type by  and confirm by  . LP -50      Not documented tPUP      Use this setting	
 Background illumination	bl on	Back lighting for display on	
	bl oFF	Display background illumination off	
	bl AU*	Backlighting for display will come on automatically as soon as the weighing scale is operated.	
 Subsequent tare value locked in devices with type approval certificate.	Str on	Subsequent tare ON	
	Str oFF*	Subsequent tare OFF	

<div style="border: 1px solid black; padding: 2px; display: inline-block;">ECH</div> Service menu	Pin	Password entry: press  ,  ,  subsequently.
Operate adjustment switch; for position see chap.17		
<div style="border: 1px solid black; padding: 2px; display: inline-block;">P1 SPd</div> Display speed	15* 30 60 7.5	Not documented
<div style="border: 1px solid black; padding: 2px; display: inline-block;">P2 CAL</div>	Adjustment, see chap. 18	
<div style="border: 1px solid black; padding: 2px; display: inline-block;">P3 Pro</div>	tri* CoUnt rESEt SEtGrA	Not documented Not documented Reset weighing scale to factory setting Not documented

\* default setting

## 13 Data output RS 232

You can print weighing data automatically via the RS 232 interface or manually by pressing  via the interface according to the setting in the menu.

This data exchange is asynchronous using ASCII - Code.

The following conditions must be met to provide successful communication between the weighing balance and the printer.

- Use a suitable cable to connect the weighing balance to the interface of the printer. Faultless operation requires an adequate KERN interface cable.
- Communication parameters (baud rate, bits and parity) of balance and printer must match. For detailed description of interface parameters see chap. 12.1)



In a medical context only auxiliary equipment in compliance with Directive EN 60601-1 may be connected to the interface.

### 13.1 Pin allocation of balance output bushing:

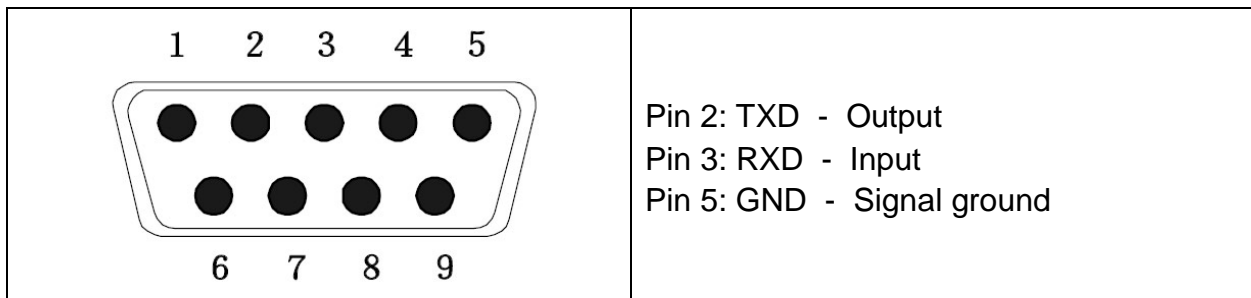

### 13.2 Technical data

Connection	9 pin d-subminiature bushing Pin 2 output Pin 3 input Pin 5 signal earth
Baud rate	Optional 600/1200/2400/4800/9600
Parity	8 bits,



### 13.3 Printer operation

Printout examples:

<b>Prt</b>	
<b>0 / 2</b>	60.0kg
<b>1 / 3</b>	60.0kg 170.0cm 20.7BMI

#### Remote control instructions:

S:

29.03.2017	09:31:21:	ST	20.0kg	stable weighing value positive
29.03.2017	09:31:51:	ST	- 20.0kg	stable weighing value negative

W:

29.03.2017	09:32:25:	US	44.3kg	instable weighing value positive
29.03.2017	09:35:33:	US	- 18.4kg	instable weighing value negative

## 14 Error messages

Display

Description

Err4

**Zero range exceeded**

(on start-up or when pressing the  key)

- Load on weighing pan
- Excess load, during zero setting of weighing scale
- Incorrect adjusting process
- Fault on load cell

Err6

**Value outside the A/D converter range**

- Damaged weighing cell
- Damaged electronics

Should other error messages occur, switch balance off and then on again. If the error message remains inform manufacturer.

## 15 Service, maintenance, disposal

### 15.1 Cleaning



Before any maintenance, cleaning and repair work disconnect the appliance from the operating voltage.

### 15.2 Cleaning / disinfecting

Clean weighing platform (such as seat) as well as casing with household detergents or commercially available disinfectants, e.g. 70% isopropanol. We recommend a disinfectant suitable for wiping disinfection. Please follow manufacturer's instructions.

Do not use abrasive or aggressive cleaners such as spirits or alcohol or similar as they might damage the high-quality surface.

To prevent cross-contamination (fungal skin infection) please observe the following time intervals for disinfection:

- Weighing plate before and after any measurement with direct skin contact
- When required:
  - Display
  - Touch-sensitive keyboard



Do not spray disinfectants onto appliance.

Make sure that disinfectant does not penetrate the interior of the balance.

Remove dirt immediately.

### 15.3 Sterilisation

Sterilisation of the appliance not allowed.

### 15.4 Disposal

Disposal of packaging and appliance must be carried out by operator according to valid national or regional law of the location where the appliance is used.

## 16 Instant help

In case of an error in the program process, briefly turn off the balance and disconnect from power supply. The weighing process must then be restarted from the beginning.

### Fault

### Possible cause

The displayed weight does not glow.

- The balance is not switched on.
- The mains supply connection has been interrupted (mains cable not plugged in/faulty).
- Power supply interrupted.
- Rechargeable battery inserted incorrectly or empty
- No rechargeable battery inserted

The displayed weight is permanently changing

- Draught/air movement
- Table/floor vibrations
- The weighing plate is in contact with foreign bodies or is not correctly positioned.
- Electromagnetic fields / static charging (choose different location/switch off interfering device if possible)

The weighing result is obviously incorrect

- The display of the balance is not at zero
- Adjustment is no longer correct.
- Great fluctuations in temperature.
- Warm-up time was ignored.
- Electromagnetic fields / static charging (choose different location/switch off interfering device if possible)

Should other error messages occur, switch balance off and then on again. If the error message remains inform manufacturer.

## 17 Verification

### General introduction:

According to EU directive 2014/31/EC balances must be officially verified if they are used as follows (legally controlled area):

- a) For commercial transactions if the price of goods is determined by weighing.
- b) For the production of medicines in pharmacies as well as for analyses in the medical and pharmaceutical laboratory.
- c) For official purposes
- d) For manufacturing final packages

In cases of doubt, please contact your local trade in standard.

### Verification notes:

An EU type approval exists for balances described in their technical data as verifiable. If a balance is used where obligation to verify exists as described above, it must be verified and re-verified at regular intervals.

Re-verification of a balance is carried out according to the respective national regulations. For verification validity period, s. chap. 17.1.

The legal regulation of the country where the balance is used must be observed!



#### **Verification of the balance is invalid without the seal.**

The seal marks attached on balances with type approval point out that the balance may only be opened and serviced by trained and authorised specialist staff. If the seal mark is destroyed, verification loses its validity. Please observe all national laws and legal regulations. In Germany a re-verification will be necessary.

### **Balances with obligation to verify must be taken out of operation if:**

- The **weighing result** of the balance is outside the **error limit**. Therefore, in regular intervals load balance with known test weight (ca. 1/3 of the max. load) and compare with displayed value.
- The **reverification deadline** has been exceeded.

**Position adjustment switch and seals:**

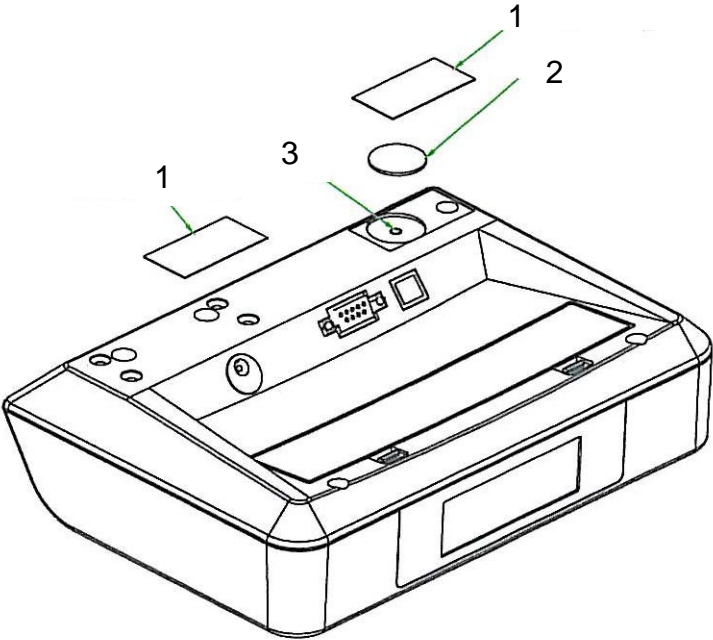

- 1. Self-destroying seal mark
- 2. Cover
- 3. Adjustment switch

### 17.1 Verification validity period (current status in G)

Personal scales (including chair and wheelchair scales) in hospitals	4 year
Personal scales, when not located in hospitals (for example, doctor's offices and nursing homes)	unlimited
Baby weighing scales and mechanical birth weight scales	4 year
Bed scales	2 year
Scales in dialysis stations	unlimited

Rehab clinics and health authorities are treated as hospitals.  
(4 years of verification validity)

Not treated as hospitals (verification validity not limited) are dialysis stations, nursing homes and doctor's surgeries.

(Details derived from: „Information by the verification authority, weighing scales applied in medical use“)







## 18 Adjustment

As the acceleration value due to gravity is not the same at every location on earth, each display unit with connected weighing plate must be coordinated - in compliance with the underlying physical weighing principle - to the existing acceleration due to gravity at its place of location (only if the weighing system has not already been adjusted to the location in the factory). This adjustment process must be carried out for the first commissioning, after each change of location as well as in case of fluctuating environment temperature. To receive accurate measuring values it is also recommended to adjust the display unit periodically in weighing operation.





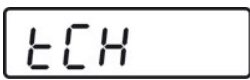











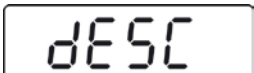

	<ul style="list-style-type: none"> <li>• Prepare the required adjustment weight. The adjustment weight to be applied depends on the capacity of a weighing scale, see chap. 1. Carry out adjustment as closely as possible to admissible maximum load of weighing scale. Information about test weights you will find in the internet under <a href="http://www.kern-sohn.com">http://www.kern-sohn.com</a></li> <li>• Observe stable environmental conditions. For warm-up time required for stabilisation see chap. 1.</li> </ul>
---	---



	<p>Access to service menu „tCH“ is locked in verified weighing scales. To disable the access lock, destroy the seal and actuate the adjustment switch. Position of the adjustment switch see chap. 17.</p> <p><b>Attention:</b> After destruction of the seal the weighing system must be re-verified by an authorised agency and a new verification wire/seal mark fitted before it can be reused for applications subject to verification.</p>
--	--

### Procedure:

  	<p>⇒ In weighing mode, press  repeatedly until <b>[tCH]</b> appears.</p>
	<p>⇒ Press  and <b>[Pin]</b> will appear.</p>

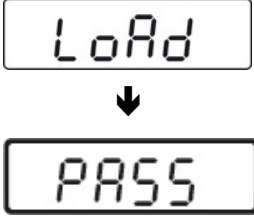

	Press  ,  and  one after the other and <b>[P1 SPd]</b> will appear
  	⇒ Press  , „P2 CAL“ will be displayed ⇒ <b>Operate adjustment switch; for position see chap.16</b>
	⇒ Press  and <b>[dESC]</b> will appear
	⇒ Press  repeatedly until „CAL“ will be displayed. ⇒ To confirm, press  and <b>[UnloAd]</b> will appear
	⇒ Ensure that there are no objects on the weighing pan. ⇒ Wait until the stability display „STABLE“ is displayed and then confirm by pressing  .
 (example)	⇒ The size of the currently set adjustment weight will be displayed. To change, select the digit to be altered by  , and the numerical value by  . ⇒ Confirm by pressing  and <b>[LoAd]</b> will be displayed.

	<ul style="list-style-type: none"> <li>⇒ Place adjustment weight in the centre of the weighing pan</li> <li>⇒ Wait until stability display „STABLE“ appears</li> <li>⇒ Confirm by pressing , <b>[PASS]</b> will be displayed.</li> </ul>
	<ul style="list-style-type: none"> <li>⇒ The balance carries out a selftest, after that <b>[Err19]</b> will be displayed and a signal will sound.</li> <li>⇒ Switch off the balance</li> <li>⇒ Take away adjustment weight</li> <li>⇒ Turn on balance again, after the selftest the balance changes into the weighing mode. Adjustment has now been completed successfully.</li> </ul>