

KERN

KERN & Sohn GmbH

Ziegelei 1
D-72336 Balingen
email: info@kern-sohn.com

Phone: +49-[0]7433- 9933-0
Fax: +49-[0]7433-9933-149
Internet: www.kern-sohn.com

Operating instructions Thermal Printer

KERN YKB-01N

Version 2.5
2019-11
GB



YKB-01N-e-1925



KERN YKB-01N

Version 2.5 2019-11

Operating Manual

Thermal printer

Printer YKB-01N is a standard thermal printer

1. Technical Data

Printout	Bi-directional thermal print with moveable 8 dot matrix head
Character composition	8x8 dot matrix
Print speed	0.75 lines
Number of characters per line	40
Character set	IBM set 2
Thermal paper	One roll, width 112mm, length 20m
Max. winding diameter	42 m
Electric Supply	8.5 V – 14 V DC
External power supply unit	230 V 50 Hz 0.12 A / 9V DC 1.3 A
energy consumption	3 W 15W
Supply interface	Type Jack 2.1
Baud rate	1200, 2400, 4800, 9600 Baud
Parameter/data format	8 or 7 bits, with or without parity control
Parity	Even or odd
Transfer protocol	Hardware-related DTR
Working life	5000 hours or 500 000 lines
Operating temperature	5°C – 35°C
Humidity of air	max. 80 % relative (not condensing)
Dimensions	165 x 140 x 50 mm
Weight	0.45 kg (excl. paper roll)

2. Declaration of -Conformity

To view the current EC/EU Declaration of Conformity go to:

www.kern-sohn.com/ce

3. Unpacking

Delivery includes:

- 1 - Printer
- 2 - Power supply unit
- 3 - Adapter cable
- 4 - 1 x Roll of thermal paper
- 5 - Operating instructions

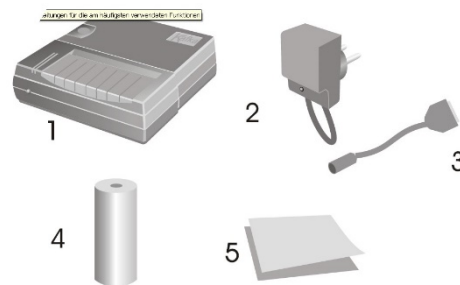

If one of the articles listed above is missing please contact your supplier immediately.

4. Installation and commissioning

Environmental conditions at the workplace chosen for the printer must meet the conditions stated below:

- Temperature: 5°C – 35°C
- Humidity: 10 – 80 % (excl. condensation)

Take notice of the following as regards to the site of operation:

- Dust and humidity free
- Do not place printer next to powerful sources of heat
- Do not place the device within range of strong electric, magnetic, electromagnetic impulse fields or planes that collect electrostatic charge.
- Do not expose printer to direct sunlight or impacts.

Power is supplied via the external mains adapter.
The stated voltage value must be the same as the local voltage.
Only use original KERN mains adapters.
Using other makes requires consent by KERN.

5. Printer parts

- 1 – ON/OFF switch
- 2 – Cover of paper compartment
- 3 – LED display ON/OFF
- 4 – Interface for connection to weighing balance
- 5 – Interface for printer supply
- 6 – Feed button

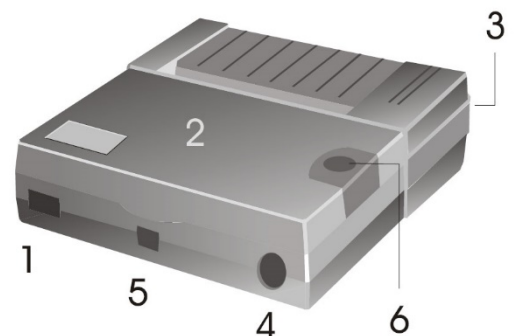

6. Preparing your printer for operation

Remove the cover from the paper compartment

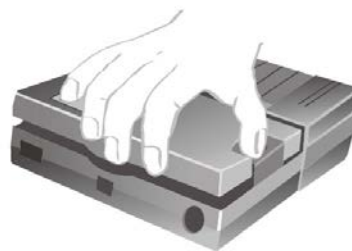

Set the micro switches

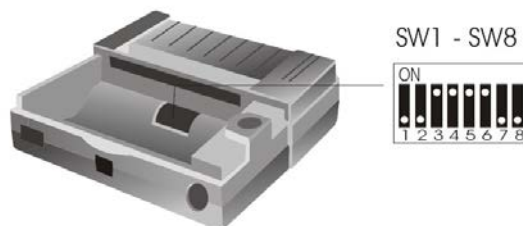

The micro switches are used to set the operating mode for the printer.

SW 1	1200 on	2400 off	4800 on	9600 off
SW 2	on	on	off	off
SW 3	on 8 bit data (no parity) off 7 bit data			
SW 4	on parity checked off ignore parity			
SW 5	on even parity off odd parity			
SW 6	on Summer time off Winter time			
Lang.	N.U.	GER.	ENG.	FRA.
SW 7	on	off	on	off
SW 8	on	on	off	off

i Changes to the settings for the micro switches must be made with the power supply turned off.
The changes are taken over when started-up again.

Connecting the cables:

There are two interfaces at the back wall of the housing:

Terminal printer cable

Terminal power supply unit

i Always use KERN accessories and weighing balances when working with your printer. Disconnect the printer from the mains voltage before connecting the cable to the printer.

Preparing the paper:

- ⇒ Fold over one end of the paper before inserting it into the printer

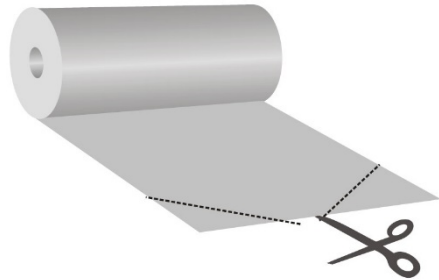

Inserting the paper

- ⇒ Insert the folded-over end of the paper into the mechanism
- ⇒ Turning on the printer supply
- ⇒ Press and hold the FEED key until the paper emerges from the outlet slot of the mechanism



Tearing off paper

- ⇒ Pull the printout across the direction of printout that it rests on the cutter bar of the printer housing

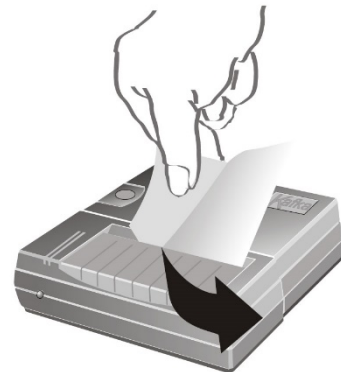

Do not pull printout upwards.

7. Operating elements

After the power supply unit has been connected to the printer and the mains, and after the ON/OFF switch of the printer has been switched to “ON” position, the red indicator for the power supply will light up.

This indicator also signals that the printer is ready for operation.

8. Start-up

⇒ On start-up press the FEED key; printer carries out self-test and parameters will be printed.

Red LED is lit up, printer is ready for operation.

⇒ Press FEED key: Turn on/off date and time

⇒ Press and hold FEED: Paper will be transported

9. Setting time and date

In order to get access to the date/time mode, switch on the printer and keep the FEED button pressed. The printer carries out a self-test, the parameters are printed.

The following note is printed at the end of the self-test:

“To set date and time push a long time the button or a short to exit.”

After this note press and hold the FEED button. The note “Set time, push a short to change value a long time to valid.” is printed.

Time and date are printed

00:45 21/01/11
(Example)

Setting time:

Press the FED button, an arrow is printed on top of the first digit of the hour display; the date display is no longer printed.

V
10:45
(Example)

Press the FEED button several times until the required hour is shown.

V
20:45
(Example)

Press and hold the FEED button in order to select the second digit. The arrow is shown on top of the second digit.

V
20:45
(Example)

Press the FEED button several times until the required hour is printed.

V
23:45
(Example)

Proceed as described above in order to change the digit of the minute display.

After having changed the time, the date/time mode can be left **either** by pressing the button for **a short period of time** or change over to set the date by pressing the button **for a long period of time**:

Setting date:

Press and hold the FEED button and the note „To set date a long time the button or a short time to exit.“ is printed.

Press and hold the FEED button to change the date. The note “Set date, push a short to change value a long time to valid.” is printed	V
The date set as the last is printed; an arrow is shown on top of the first digit of the day display.	11/01/11 (Example)

Press the FEED button several times until the required number is printed	V
	21/01/11 (Example)

Press and hold the FEED button in order to select the second digit	V
	21/01/11 (Example)

Press the FEED button several times until the required day is printed	V
	25/01/11 (Example)

Proceed as described above in order to set the month and the year.

After having set all digits, press and hold the FEED button and the date/time mode is left. The note: „Exit of date and time menu.“ appears.

10. GLP log

After actuating the ON/OFF switch, the printer head will move. During this movement actuate shortly the FEED button.

The following log is created and can be completed hand-written:

Documentation of Adjustment (GLP)

Date: _____ Hour: _____
Balance _____
Manufacturer: _____
Model: _____
Serial no.: _____
ID: _____

Adjustment weight

external internal
Serial no.: _____
Rated value: _____
Class: _____

Adjustment successful:

yes no

Auditor: _____
Signature: _____

11. Storage conditions and use of thermal paper

Long-term usability of thermal paper is achieved by correct storage.

- i** Storage:
- Dark storage location (no direct sunlight)
 - Maximum relative air humidity 65%
 - Maximum temperature 25°C

Always store printed paper under the following conditions:

- i**
- Do not expose to direct sunlight or intensive room lights
 - Avoid contact with alcohol, solvents or similar substances (e. g. adhesives),
 - Do not store inside PVC pockets
 - Storage temperature < 25°C.

12. Printer cable

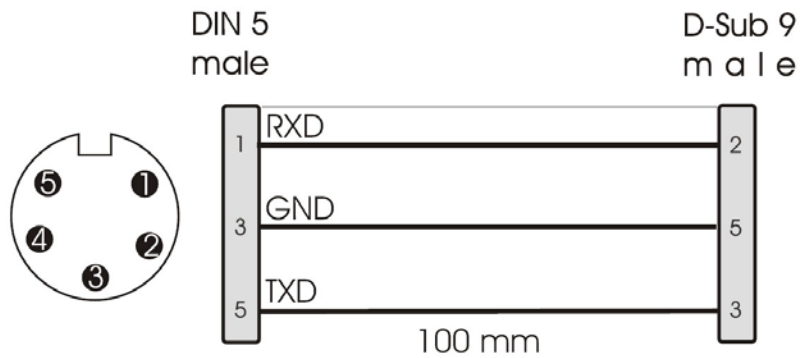

13. Instant help

Symptom

Remedy

The supply indicator is not lit up.

Check whether the power supply unit is connected to the printer and to the mains.

Paper does not emerge.

Check whether the paper has been inserted correctly, whether the input slot of the mechanism is free of obstructions

Paper leaves printer without print:

Check whether the paper has been inserted with its thermo-sensitive side facing the printer head, whether the SW switches are set correctly.

No printing is taking place and paper does not emerge.

Check whether the connecting cable is connected at both ends, whether the printer prints during the self-test, whether the SW switches are set correctly.

Wrong characters are printed

Check whether SW switches are set correctly.

Printout is blurred

Check whether operating temperature exceeds allowed value, whether the paper used is recommended by the manufacturer.

If you are unable to remedy the error, please contact your supplier.